

YASKAWA

HV600

HVAC DRIVES FOR FAN AND PUMP APPLICATIONS

IT'S PERSONAL



UNIQUELY DESIGNED FOR BUILDING AUTOMATION

Yaskawa Variable Frequency Drives continue to deliver high quality, top-tier solutions that maximize building automation system performance – AND make you money.

HIGH PERFORMANCE THAT PUSHES EXPECTATIONS

Building owners. Facility managers. Mechanical contractors specifying drives. They all trust Yaskawa to deliver reliable performance in HVAC applications.

Yaskawa offers:

- Industry experience
- Quick commissioning
- Easy-to-use interface
- Quick delivery
- Product quality

The HV600 family of drives pushes past industry requirements to establish a new benchmark for industry expectations.

In fact, the HV600 addresses all of the most pressing demands, including more flexibility and control, less downtime and more packaging options.

HV600 Drives

- 208 VAC: 3 to 100 HP
- 480 VAC: 3 to 250 HP

HV600 Bypass Packages

- 208 VAC: 0.5 to 100 HP
- 240 VAC: 0.5 to 100 HP
- 480 VAC: 0.75 to 250 HP

HV600 Configured Packages

- 208 VAC: 0.5 to 100 HP
- 240 VAC: 0.5 to 100 HP
- 480 VAC: 0.75 to 250 HP



HV600 Drive Family



Yaskawa's Building Automation Group is dedicated to listening to each of our different customer types to better understand each of their needs.

BUILDING OWNERS

Expect maximum customer comfort at minimal cost.

FACILITY MANAGERS

Expect simple maintenance, error free operation and specifications to be met.

SPECIFYING ENGINEERS

Expect compliance to industry trends, customer acceptance, and quick and accurate commissioning.

MECHANICAL OR ELECTRICAL CONTRACTORS

Expect easy installation and programming and quick response to any questions.

HVAC CONTROL CONTRACTORS

Expect integrated control, stable software, and compatibility across various platforms.

MAINTENANCE & SERVICE CONTRACTORS

Expect to easily identify and quickly resolve problems by replacement or field maintenance.



Yaskawa has delivered great HVAC solutions to customers since 1988.



YASKAWA HAS WHAT YOU NEED

- ✓ Use for both indoor and outdoor applications
- ✓ Space saving, vertical design
- ✓ Enhanced pump control & protection
- ✓ Easy access to wiring
- ✓ Emergency Override for increased safety
- ✓ High ambient temperature ratings
- ✓ Fastest to commission

EXCEEDING YOUR ENERGY & COMFORT EXPECTATIONS

More than a quarter million installed Yaskawa VFDs reliably save energy and supply fresh air and water to the buildings we use every day.

Office buildings are probably the most common type of facility that benefit from using Variable Frequency Drives. But many other buildings can benefit from the energy savings and carbon footprint reduction provided by VFDs, including:

- Government facilities
- Educational facilities
- Medical facilities
- Parking structures
- Data centers
- Large apartments and condominiums

A Yaskawa representative, or partner, can help you wherever usage can deliver the biggest return on your investment.

- Supply and return fans
- Condensing fans
- Cooling tower fans
- Fan arrays
- Condenser water pumps
- Chilled water pumps
- Chiller compressors
- Booster pumps



SAVE ENERGY

SAVE MONEY

Yaskawa variable frequency drives can reduce air handling and cooling energy costs **up to 70%**.



Variable Frequency Drives Reduce Energy Use

A typical fan or pump running at 50% speed will use one-fifth as much energy compared to systems using mechanical control methods. The primary reason VFDs reduce energy and improve system efficiency is due to the elimination of throttling, which has been the traditional method of mechanically adjusting air or water flow in a system. VFDs control the speed of fans, pumps and compressors.

Building owners can typically expect 20-70% energy savings when applying VFDs to fan and pump systems while creating a more comfortable work environment. VFDs are the perfect marriage between comfort and sustainability.

The HV600 family of drives also contributes toward LEED credits and help buildings meet or exceed Energy Star Certification.

- Reduced mechanical and electrical stress on fan belts, compressors and pumps
- Reduction or elimination of demand charges
- Power factor improvement
- Control and monitoring via communication protocol

1/5

USING A VFD TO REDUCE FAN OR PUMP SPEED TO 50% IN LOW DEMAND SITUATIONS WILL USE ONLY 1/5 THE ENERGY OF FULL SPEED OPERATION.

70%

VFDS CAN REDUCE HVAC ENERGY COSTS UP TO 70%.

25%

AIR HANDLING SYSTEMS ACCOUNT FOR 25% OF ELECTRICITY USED IN A TYPICAL OFFICE BUILDING.

100%

YASKAWA WILL COMMIT 100% TO PROVIDING YOU THE BEST QUALITY, SERVICE AND TRAINING POSSIBLE.



Restriction of Hazardous Substances



Leadership in Energy and Environmental Design



EPA Program to Promote Superior Energy Efficiency



Energy Efficiency with Reduction of Carbon Footprint

ADVANTAGE YASKAWA

The latest offering for the HVAC industry from Yaskawa, the HV600, is sustainable, flexible, and easy.

EXCEPTIONAL DESIGN

Specifically designed for building automation applications, the HV600 helps minimize energy costs and maximize occupant comfort.

Available in IP20/UL Type 1 and IP55/UL Type 12 versions, the HV600 can be mounted without the need for an expensive additional enclosure. With a high contrast display HOA keypad, a high visibility status ring, and enhanced pump control functionality, the HV600 is perfectly suited to building automation application needs.

Control for a wide variety of motor types, along with mobile device programming and clear status indication, make the HV600 the efficient, reliable choice for smart building control.



IP20/UL Type 1

IP55/UL Type 12

208 VAC Models: 3 - 100 HP (2.2 - 75 kW)
480 VAC Models: 3 - 250 HP (2.2 - 186 kW)

HV600 Intelligent Bypass

DESIGNED FOR EASE-OF-USE

The easy-to-integrate HV600 bypass is designed in the bookshelf style, in either a two-contactor or a three-contactor arrangement. The bypass cover has a streamlined, visually appealing shape and the HV600 keypad stays with the frame, not the cover, when the cover is removed.

All programming is done through a single keypad with intuitive interface. All BACnet® control is implemented through a single node. The bypass mirrors the drive multi-function digital outputs and uses a single password for both the bypass and the drive to simplify access.

PREMIER RELIABILITY



HV600 Narrow Bypass Package

The HV600 is the next step closer to tripless operation. Rapid detection of the incoming line voltage enables extended power-loss ride-through and consistent operation during switchover to generator supply. With zero-cross switching, the bypass contactors will be opened and closed when the control voltage sine wave is at its zero point, thus reducing electrical noise and relay arcing.

The HV600 eliminates premature drive failures when output disconnect is inadvertently opened under power.

The HV600 bypass integrated motor overload relays accomplish motor overload protection in software as opposed to traditional magnetic overloads, which means fewer mechanical points of potential failure.

BACnet is a registered trademarks of the American Society of Heating, Refrigerating and Air-Conditioning Engineers, Inc.



QUICK AND EASY SET-UP

- Simple steps for efficient commissioning
- DriveWizard® HVAC support tool for PCs
- DriveWizard Mobile app for drive management on smart mobile devices
- Safe programming without main three-phase power

EASE OF INSTALLATION

- Side-by-side mounting*
- IP20/UL Type 1, IP55/UL Type 12, IP20/Protected Chassis
- -10°C to +60°C ambient*
- Plenum rated

SIMPLE OPERATION

- Real-time clock for scheduled functions
- Hand-Off-Auto keypad with LCD display and tactile buttons
- Timer controls for starting, stopping, and speed changes

DESIGNED FOR BUILDING AUTOMATION

- Built-in building automation protocols
- Emergency Override for occupant safety in fire events
- Compliance with global certifications and standards

BUILDING-SPECIFIC DESIGN

- Built-in line impedance for harmonic reduction
- On board EMC/RFI filter*
- Conformal coating for circuit board protection

APPLICATION PRESETS

- Fan
- Fan with PI Control
- Return Fan with PI Control
- Cooling Tower Fan
- Cooling Tower Fan with PI Control
- Pump
- Pump with PI Control

*See manual for specific drive ratings

HVAC MADE EASY

The HV600 keypad has all the features you need intuitively at your fingertips, its simplicity is what makes it the fastest in the industry to commission.

CHOICE OF PROTECTION RATINGS

The HV600 comes standard from the factory with a choice of IP20/UL Type 1, IP55/UL Type 12, and IP20/Protected Chassis with ambient temperature ratings up to 50°C. Ratings up to 60°C can be achieved with current derating.

SIDE-BY-SIDE

Most HV600 models can be mounted side-by-side with bottom entry wiring to maximize cabinet space.

PANEL MOUNTING

When mounted in a separate enclosure, heat management can be accomplished by removing detachable top and bottom covers on the drive or by “back side” mounting the standard drive with the heatsink external to the enclosure.

DIGITAL AND ANALOG I/O

All the features expected for efficient building operation come standard with the HV600. Customer-supplied 24 VDC input control power ensures network communications are maintained even during loss of main input power. A full complement of analog and digital inputs are built in and are customizable for user requirements.

ENHANCED PUMP CONTROL

The HV600 includes intelligent pump control capable of single failure-proof booster pump control. It also has built-in deadhead protection, loss of prime detection, and many other pump system protection features. The HV600 protects your building.

FLEXIBLE MOTOR CONTROL

- Induction and permanent magnet motors
- Synchronous reluctance (SynRM) motors
- 400 Hz output frequency

PLENUM RATED

All HV600 IP20/UL Type 1 and IP55/UL Type 12 models are plenum rated for building automation applications.



FASTEST
TO COMMISSION



BLUETOOTH® Option
Use the DriveWizard Mobile Application to manage HV600 drives and packages with optional Bluetooth keypad connectivity.

Copy Function
Multiple sets of parameters can be stored and easily copied to additional drives.

High-Contrast Display
Contrast control offers clear and readable full-text descriptions.

Automatic Backup Function
Saves the current parameter settings after a user-defined period of inactivity. After an incident, settings can be easily retrieved from the keypad.



Micro SD Slot
Micro SD storage for data logging.

Real-Time Clock
Real-time clock for time and date stamp of fault information.

Advanced Keypad Navigation
Shortcuts, scrolling and function keys offer faster navigation.

Bluetooth® and the Bluetooth logo are registered trademarks of Bluetooth SIG, Inc. USA.

CONFORMANCE TO INDUSTRY STANDARDS

HV600 drives conform to a variety of industry standards from various governing bodies:



NETWORK COMPATIBILITY

HV600 drives are compatible with the most popular HVAC protocols:



EXTENSIVE PROGRAMMING SOLUTIONS

The HV600 can be programmed with its resident keypad, a mobile device or personal computer. Whatever you choose, enjoy easy navigation and guided wizards for configuration, monitoring and troubleshooting.

MOBILE DEVICE CONNECTIVITY

Use the free Yaskawa DriveWizard Mobile Application for iPhone®, iPad®, or Android™ to manage your drive. Connect with Bluetooth or to the built-in USB port using a USB On-The-Go (OTG) enabled Android device.



DRIVEWIZARD MOBILE



The DriveWizard Mobile app turns your smartphone or tablet into an interface for your HV600 drive. All information for parameter setup and troubleshooting are in your pocket, anytime, anywhere. Save HV600 settings to your smart device or to the free and secure Yaskawa Drive Cloud™ service.

DriveWizard Mobile also provides:

- Intuitive parameter editing with help and search function
- Custom parameter and monitor lists
- Compare setting differences between the drive and backup files
- Simple support activities, such as the ability to email drive settings
- Parameter backup/verify with or without main power applied to the drive
- Backup and restore drive settings to the free and secure Yaskawa Drive Cloud service
- Parameter file compatibility with DriveWizard HVAC

CONVENIENT PROGRAMMING WITHOUT MAIN POWER

Simplify commissioning. Program the drive in its packaging without the need for three-phase power. Simply use a USB On-The-Go (OTG) enabled Android device and USB OTG cable.

iPhone and iPad are registered trademarks of Apple Inc. Android is a trademark of Google LLC



DRIVEWIZARD® HVAC

- Connect via USB and interface with the HV600 even without main power
- Create configurations offline, then later connect and download them to HV600
- Monitor a dashboard of dynamic variables and discrete information
- Chart your process with up to 16 channels of recorded data
- Create reports for exporting and emailing
- Import and export DriveWizard mobile parameter files
- Convert settings for previous generation drives series to the new HV600 series

NO MAIN POWER?

CONNECT VIA USB!

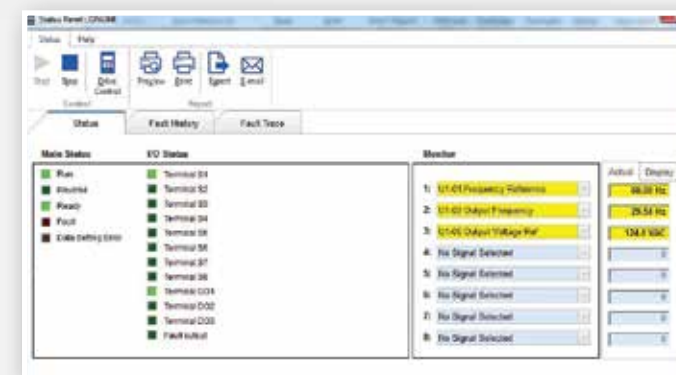
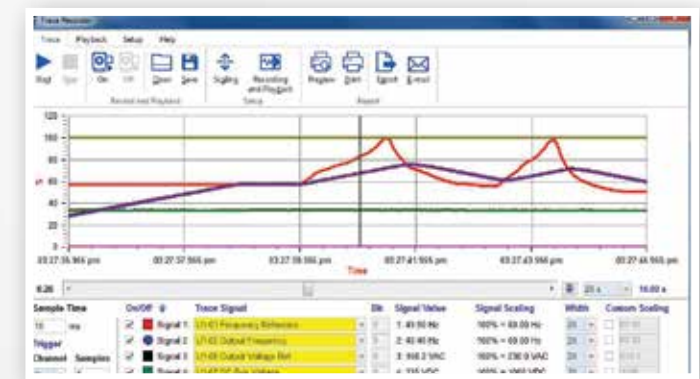
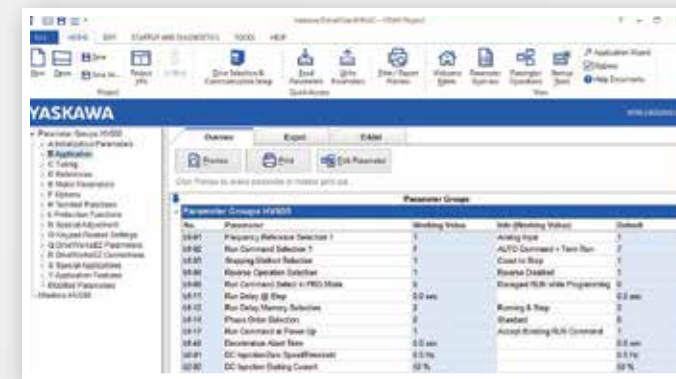

HV600 AC DRIVE

Catalog Code Designation

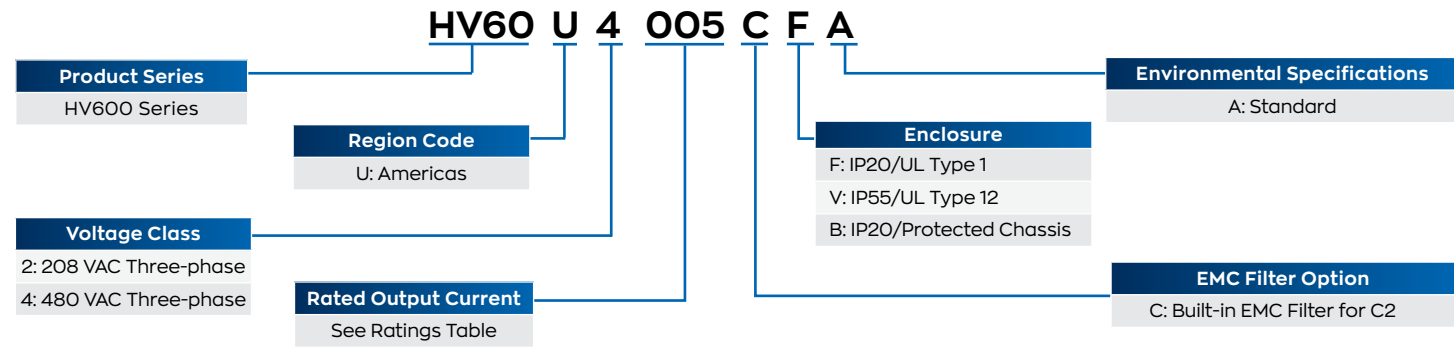

Note: Optional Bluetooth keypad (JVOP-KPLCD04ABB) ordered separately

Models and Ratings

IP20/UL TYPE 1

208 VAC MODELS												
HV60U2□□□CFA	011	017	024	031	046	059	075	088	114	143	169	
Rated Output Current (A)	10.6	16.7	24.2	30.8	46.2	59.4	74.8	88	114	143	169	
kW Rating	2.2	3.7	5.5	7.5	11	15	18.5	22	30	37	45	
Nominal HP	3	5	7.5	10	15	20	25	30	40	50	60	
Frame Size	1	1	2	2	3	3	4	4	4	6	6	
Dimensions (in)	Height	14.1	14.1	17.6	17.6	20.1	20.1	21.3	21.3	21.3	30.5	30.5
	Width	4.9	4.9	4.9	4.9	7.9	7.9	10.0	10.0	10.0	12.3	12.3
	Depth	8.6	8.6	9.2	9.2	9.3	9.3	10.4	10.4	10.4	15.7	15.7
Heat Loss (W)	Heatsink	86	140	184	244	314	418	538	615	780	937	1132
	Internal	45	56	75	89	116	148	175	201	246	244	279
	Total	131	196	259	333	430	566	713	816	1026	1180	1411

480 VAC MODELS															
HV60U4□□□CFA	005	008	011	014	021	027	034	040	052	065	077	096	124	156	
Rated Output Current (A)	4.8	7.6	11	14	21	27	34	40	52	65	77	96	124	156	
kW Rating	2.2	3.7	5.6	7.5	11.2	15	18.6	22	30	37	45	56	75	93	
Nominal HP	3	5	7.5	10	15	20	25	30	40	50	60	75	100	125	
Frame Size	1	1	1	1	2	2	2	3	3	3	4	4	4	6	
Dimensions (in)	Height	14.1	14.1	14.1	14.1	17.6	17.6	17.6	20.1	20.1	20.1	21.3	21.3	21.3	30.5
	Width	4.9	4.9	4.9	4.9	4.9	4.9	4.9	7.9	7.9	7.9	10.0	10.0	10.0	12.3
	Depth	8.6	8.6	8.6	8.6	9.2	9.2	9.2	9.3	9.3	9.3	10.4	10.4	10.4	15.7
Heat Loss (W)	Heatsink	39	63	142	196	212	285	327	373	470	600	819	973	1294	1448
	Internal	36	45	56	66	89	112	128	145	178	224	271	323	423	332
	Total	75	108	198	262	301	397	455	518	648	824	1090	1295	1717	1780



Yaskawa is committed to delivering the highest quality in all aspects of its business. From product development to manufacturing all the way through technical support and field service.

IP55/UL TYPE 12

208 VAC MODELS										
HV60U2□□□	011	017	024	031	046	059	075	088	114	
Rated Output Current (A)	10.6	16.7	24.2	30.8	46.2	59.4	74.8	88	114	
kW Rating	2.2	3.7	5.5	7.5	11	15	18.5	22	30	
Nominal HP	3	5	7.5	10	15	20	25	30	40	
Frame Size	1	1	2	2	3	3	4	4	4	
Dimensions (in)	Height	14.1	14.1	17.6	17.6	20.1	20.1	21.3	21.3	21.3
	Width	4.9	4.9	4.9	4.9	7.9	7.9	10.0	10.0	10.0
	Depth	9.0	9.0	9.6	9.6	9.7	9.7	10.7	10.7	10.7
Heat Loss (W)	Heatsink	86	140	184	244	314	418	538	615	780
	Internal	45	56	75	89	116	148	175	201	246
	Total	131	196	259	333	430	566	713	816	1026

480 VAC MODELS														
HV60U4□□□	005	008	011	014	021	027	034	040	052	065	077	096	124	
Rated Output Current (A)	4.8	7.6	11	14	21	27	34	40	52	65	77	96	124	
kW Rating	2.2	3.7	5.6	7.5	11.2	15	18.6	22	30	37	45	56	75	
Nominal HP	3	5	7.5	10	15	20	25	30	40	50	60	75	100	
Frame Size	1	1	1	1	2	2	2	3	3	3	4	4	4	
Dimensions (in)	Height	14.1	14.1	14.1	14.1	17.6	17.6	17.6	20.1	20.1	20.1	21.3	21.3	21.3
	Width	4.9	4.9	4.9	4.9	4.9	4.9	4.9	7.9	7.9	7.9	10.0	10.0	10.0
	Depth	9.0	9.0	9.0	9.0	9.6	9.6	9.6	9.7	9.7	9.7	10.7	10.7	10.7
Heat Loss (W)	Heatsink	39	63	142	196	212	285	327	373	470	600	819	973	1294
	Internal	36	45	56	66	89	112	128	145	178	224	271	323	423
	Total	75	108	198	262	301	397	455	518	648	824	1090	1295	1717

IP20/PROTECTED CHASSIS

208 VAC MODELS			
HV60U2□□□	211	273	
Rated Output Current (A)	211	273	
kW Rating	55	75	
Nominal HP	75	100	
Frame Size	9	9	
Dimensions (in)	Height	36.0	36.0
	Width	12.4	12.4
	Depth	16.5	16.5
Heat Loss (W)	Heatsink	1321	1821
	Internal	331	423
	Total	1651	2244

480 VAC MODELS				
HV60U4□□□	180	240	302	
Rated Output Current (A)	180	240	303	
kW Rating	112	150	186	
Nominal HP	150	200	250	
Frame Size	9	9	10	
Dimensions (in)	Height	27.6	27.6	31.5
	Width	12.3	12.3	17.3
	Depth	16.5	16.5	18.6
Heat Loss (W)	Heatsink	1707	1810	2847
	Internal	395	406	866
	Total	2102	2216	3712

CONNECTION DIAGRAM

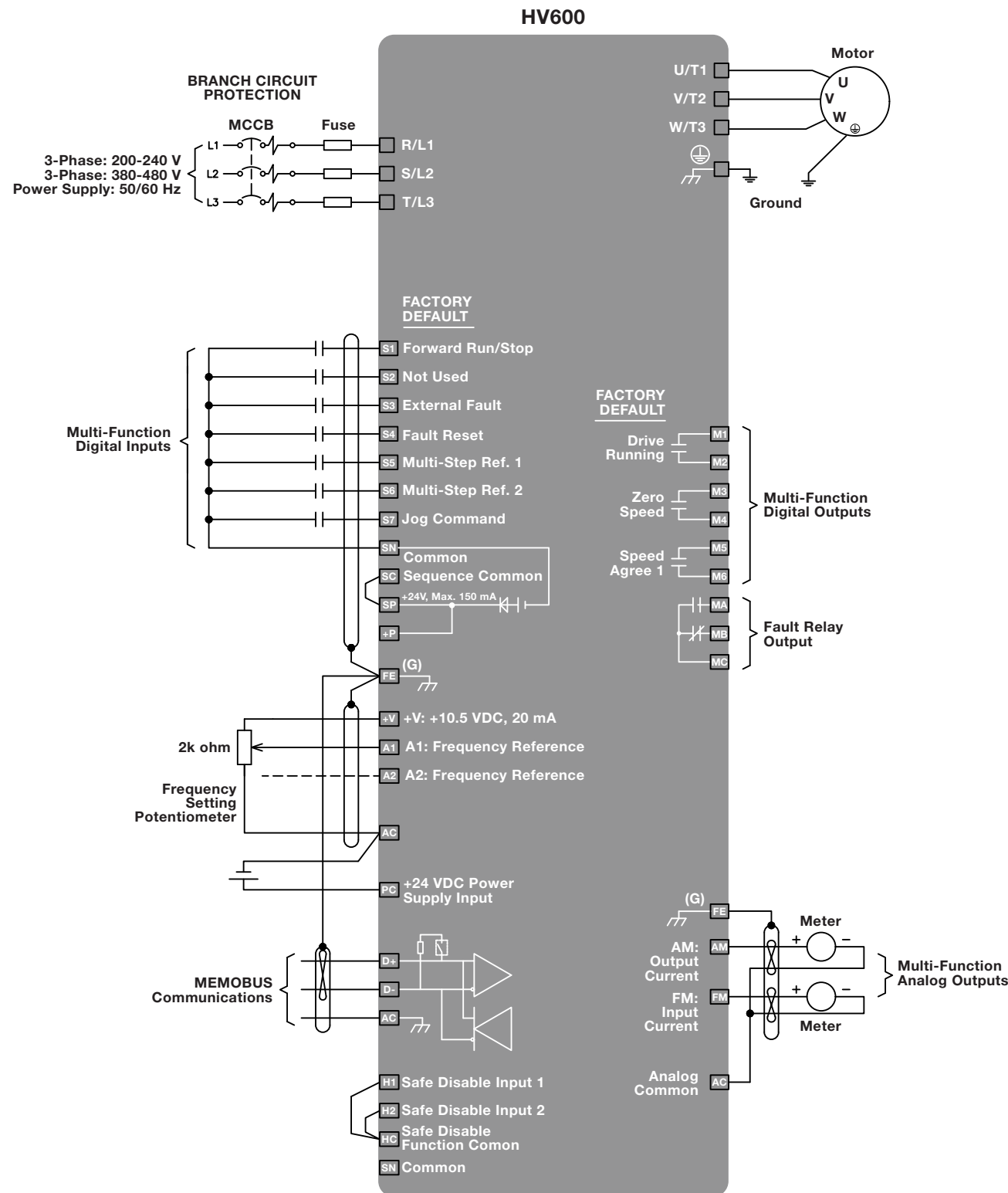

SPECIFICATIONS

Item	Specifications
Input Voltage	Three-phase 200 to 240 VAC, 380 to 480 VAC, +10%/-15%, 50/60 Hz +/-5%
Ambient Operating Temperature	-10°C to +50°C (14°F to 122°F), up to 60°C (140°F) with derating
Ambient Storage Temperature	-20°C to +70°C (-4°F to 158°F)
Overload Capacity	110% for 60 seconds, 140% for 2 seconds, 175% instantaneous
Output Frequency	0 to 400 Hz
Environmental	1,000 meters altitude, up to 4,000 meters with derating Class 3C2 and 3S2 operation for IP20/UL Type 1, Class 3C2 and 3S3 for IP55/UL Type 12 95% humidity, non-condensing IP20/UL Type 1 and IP55/Type 12 plenum rated
EMC and Harmonics	EMC filter built in; complies with IEC 61800-3 restricted distribution for first environment 5% split choke built in both positive and negative DC bus leg as standard
Control Methods	Open Loop V/f Open Loop Vector for PM motors only
Motor Types	Induction Permanent Magnet Synchronous Reluctance
Protective Design Types	IP20/UL Type 1 IP55/UL Type 12 IP20/Protected Chassis
Interface	LCD keypad with Hand-Off-Auto and Status Ring, Bluetooth keypad optional
Global Certifications	UL, cUL, CE, RoHS 2, WEEE, TUV SUD
Functional Safety	Safe Torque Off, SIL3 according to IEC 62061, PLe according to ISO 1384
Standard I/O	(7) programmable multi-function digital inputs (24 VDC) (2) programmable multi-function analog inputs (0 to +10 VDC, 0-20 mA, 4-20 mA) (2) functional Safety inputs (1) fault relay output (Form C) (3) programmable multi-function relay outputs (Form A) (2) programmable multi-function analog output (0 to +10 VDC, 0-20 mA, 4-20 mA)
24 VDC power	External supply input to maintain communications without main power 150 mA output for customer use
Network Communications	Built in: BACnet MSTP, Siemens APOGEE® FLN P1, Johnson Controls Metasys® N2, and Modbus® RTU Optional: LONWORKS®, ETHERNET/IP™ and Modbus® TCP/IP
Software Support Tools	DriveWizard® HVAC DriveWizard® Mobile Programming Simulator Energy Savings Predictor Harmonics Estimator DriveWorksEZ®

* See manual for specific drive ratings

APOGEE is a registered trademark of Siemens Building Technologies.

Metasys is a registered trademark of Johnson Controls.

Modbus is a registered trademark of Schneider Electric, licensed to the Modbus Organization, Inc.

LONWORKS is a registered trademark of Echelon Corporation.

ETHERNET/IP is a trademark of ODVA, Inc.

HV600 NARROW BYPASS

HVAC Optimized with Intelligent Bypass and Advanced BAS Interface

HOW TO SELECT AN HV600 NARROW BYPASS PACKAGE

To construct a Narrow Bypass model number, find the base number for the required enclosure type, voltage, and current rating. Add the option code for each required option. Power options are preceded by 'P', control options are preceded by 'T'.

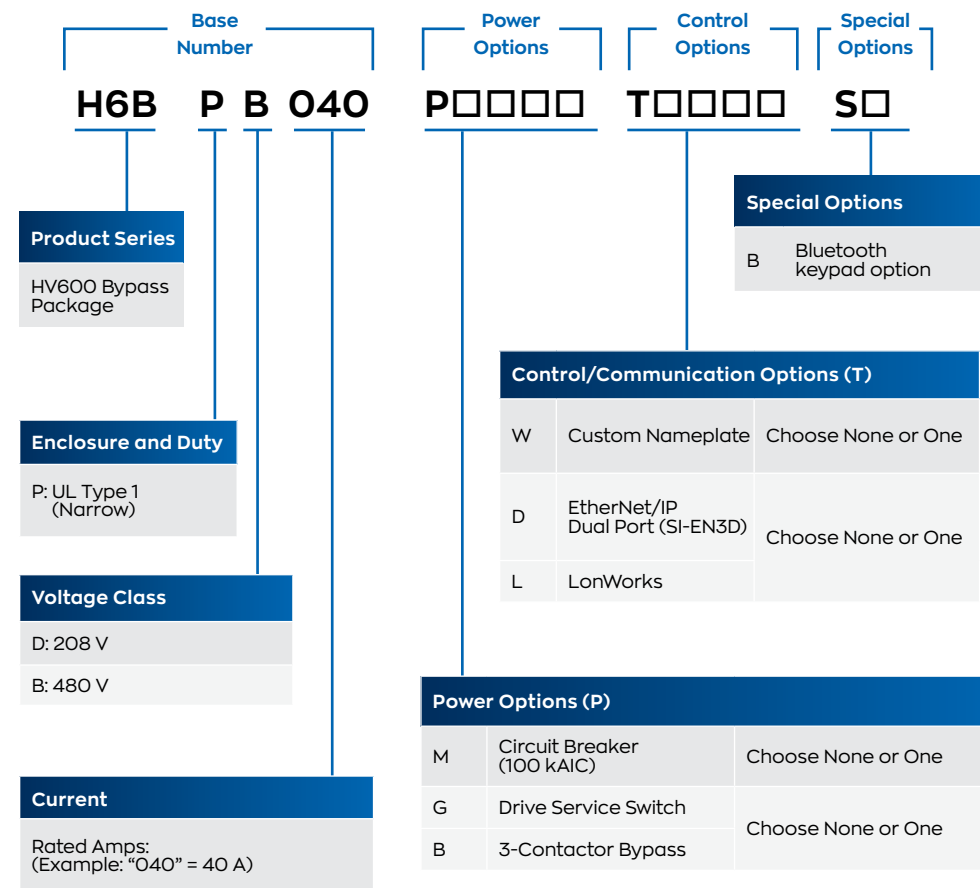

Note: Contact Yaskawa representative for possible exclusions.



FEATURES

- Two-contactor bypass
- 100 kAIC package rating
- Non-fused disconnect
- HOA keypad
- Standard digital inputs
 - Run
 - Safety
 - BAS interlock
 - Auto transfer to bypass
 - Emergency override
- (3) Programmable digital inputs
- (4) Form C programmable relays
- Built-in communications
 - BACnet
 - APOGEE
 - Metasys
 - Modbus

OPTIONS

- Circuit breaker: 100 kAIC
- Drive service switch
- Three-contactor bypass
- Custom nameplate
- LonWorks
- EtherNet/IP
- Bluetooth HOA keypad

Models and Ratings

208 VAC MODELS

Base No.: H6BPD□□□	002	003	004	007	010	016	024	030	046	059	074
Rated Output Current (A)	2.4	3.5	4.6	7.5	10.6	16.7	24.2	30.8	46.2	59.4	74.8
Nominal HP	0.5	0.75	1	2	3	5	7.5	10	15	20	25
Physical Size UL Type 1 H6BPD□□□	Height	41.6	41.6	41.6	41.6	41.6	45.2	45.2	48.7	48.7	52.1
	Width	6.3	6.3	6.3	6.3	6.3	6.3	6.3	9.4	9.4	11.9
	Depth	14.7	14.7	14.7	14.7	14.7	14.7	14.7	14.7	15.3	16.6
	Weight	55	55	55	55	55	55	62	64	87	92

480 VAC MODELS

Base No.: H6BPB□□□	001	002	003	004	007	011	014	021	027	034	040	052	065	077
Rated Output Current (A)	1.6	2.1	3.4	4.8	7.6	11	14	21	27	34	40	52	65	77
Nominal HP	0.75	1	2	3	5	7.5	10	15	20	25	30	40	50	60
Physical Size UL Type 1 H6BPB□□□	Height	41.6	41.6	41.6	41.6	41.6	41.6	45.2	45.2	48.7	48.7	48.7	52.1	52.1
	Width	6.4	6.4	6.4	6.4	6.4	6.4	6.4	6.4	9.4	9.4	9.4	11.9	11.9
	Depth	14.7	14.7	14.7	14.7	14.7	14.7	14.7	14.7	14.7	15.3	15.3	16.6	16.6
	Weight	56	56	56	56	56	56	56	62	65	81	90	96	121

HV600 ENCLOSED BYPASS

HVAC Optimized with Intelligent Bypass and Advanced BAS Interface

HOW TO SELECT AN HV600 ENCLOSED BYPASS PACKAGE

To construct a Enclosed Bypass model number, find the base number for the required enclosure type, voltage, and current rating. Add the option code for each required option. Power options are preceded by 'P', control options are preceded by 'T'.

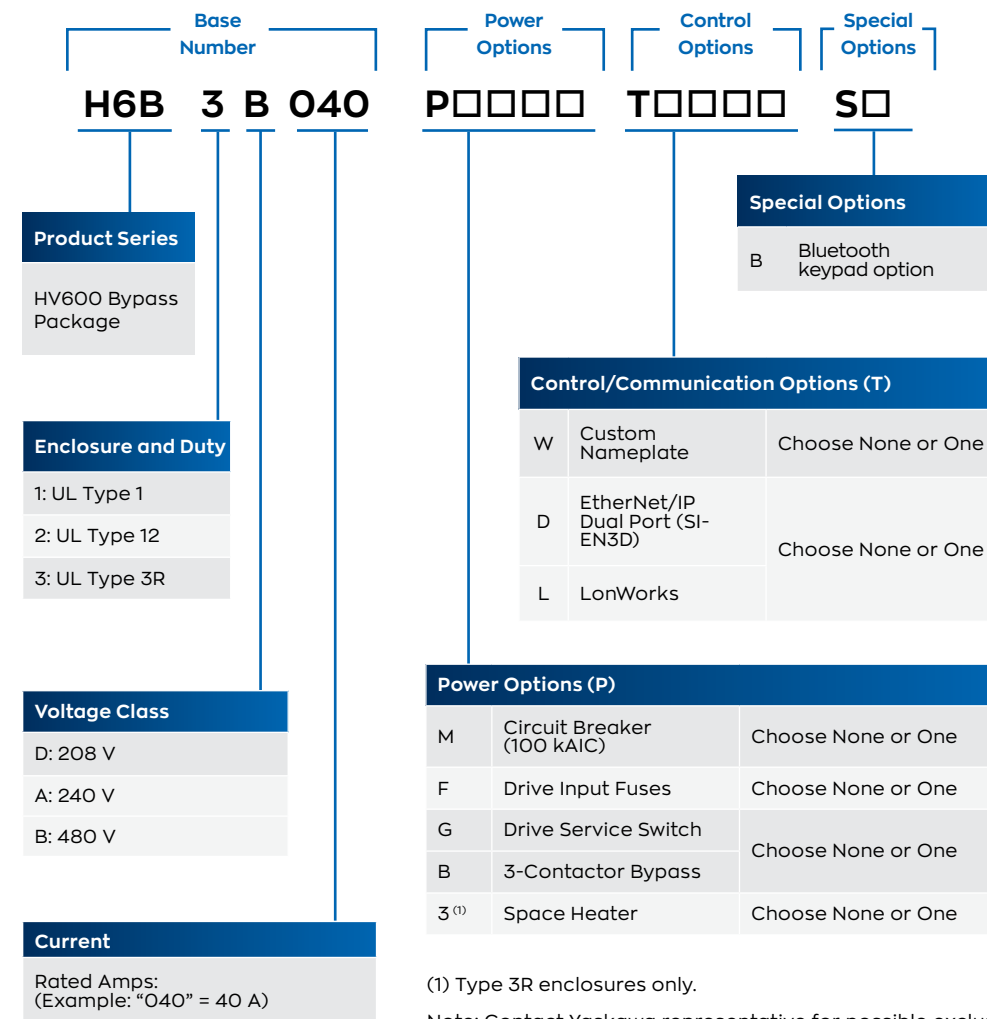

Floor and Wall Mount Packages

FEATURES

- Two-contactor bypass
- 100 kAIC package rating
- Non-fused disconnect
- HOA keypad
- Standard digital inputs
 - Run
 - Safety
 - BAS interlock
 - Auto transfer to bypass
 - Emergency override
- (3) Programmable digital inputs
- (4) Form C programmable relays
- Built-in communications
 - BACnet
 - APOGEE
 - Metasys
 - Modbus

OPTIONS

- Circuit breaker: 100 kAIC
- Drive service switch
- Three-contactor bypass
- Custom nameplate
- LonWorks
- EtherNet/IP
- Bluetooth HOA keypad

Models and Ratings

208 VAC MODELS

Base No. : H6B□D□□□		002	003	004	007	010	016	024	030	046	059	074	088	114	143	169	211	273	
Rated Output Current (A)		2.4	3.5	4.6	7.5	10.6	16.7	24.2	30.8	46.2	59.4	74.8	88	114	143	169	211	273	
Nominal HP		0.5	0.75	1	2	3	5	7.5	10	15	20	25	30	40	50	60	75	100	
Physical Size	UL Type 1 H6B1D□□□	Height	25.9	25.9	25.9	25.9	25.9	25.9	33.9	33.9	37.1	37.1	42.1	42.1	42.1	53.1	53.1	87.0	87.0
		Width	15.7	15.7	15.7	15.7	15.7	15.7	18.7	18.7	20.8	20.8	25.6	25.6	25.6	33.8	33.8	42.0	42.0
		Depth	15.6	15.6	15.6	15.6	15.6	15.6	17.6	17.6	18.5	18.5	18.9	18.9	18.9	20.5	20.5	33.5	33.5
		Weight	93	93	93	93	93	93	125	128	159	163	224	233	248	419	434	832	859
	UL Type 12 H6B2D□□□	Height	27.1	27.1	27.1	27.1	27.1	27.1	34.1	34.1	37.3	37.3	43.6	43.6	43.6	55.0	55.0	85.4	85.4
		Width	18.3	18.3	18.3	18.3	18.3	18.3	19.3	19.3	24.5	24.5	26.3	26.3	26.3	33.3	33.3	41.3	41.3
		Depth	18.8	18.8	18.8	18.8	18.8	18.8	18.9	18.9	19.0	19.0	21.4	21.4	21.4	26.3	26.3	34.4	34.4
		Weight	104	104	104	104	104	104	137	141	189	193	266	272	285	486	502	853	867
	UL Type 3R H6B3D□□□	Height	39.2	39.2	39.2	39.2	39.2	39.2	39.2	39.2	44.2	44.2	49.2	49.2	49.2	61.2	61.2	92.6	92.6
		Width	18.6	18.6	18.6	18.6	18.6	18.6	18.6	18.6	20.6	20.6	26.6	26.6	26.6	38.6	38.6	43.6	43.6
		Depth	18.1	18.1	18.1	18.1	18.1	18.1	18.1	18.1	20.1	20.1	22.1	22.1	22.1	25.1	25.1	48.6	48.6
		Weight	150	150	150	150	150	150	155	157	176	182	284	289	300	554	567	1039	1054

240 VAC MODELS

Base No. : H6B□A□□□		002	003	004	006	009	015	022	028	042	054	068	080	104	130	154	192	248	
Rated Output Current (A)		2.2	3.2	4.2	6.8	9.6	15.2	22	28	42	54	68	80	104	130	154	192	248	
Nominal HP		0.5	0.75	1	2	3	5	7.5	10	15	20	25	30	40	50	60	75	100	
Physical Size	UL Type 1 H6B1A□□□	Height	25.9	25.9	25.9	25.9	25.9	25.9	33.9	33.9	37.1	37.1	42.1	42.1	42.1	53.1	53.1	87.0	87.0
		Width	15.7	15.7	15.7	15.7	15.7	15.7	18.7	18.7	20.8	20.8	25.6	25.6	25.6	33.8	33.8	42.0	42.0
		Depth	15.6	15.6	15.6	15.6	15.6	15.6	17.6	17.6	18.5	18.5	18.9	18.9	18.9	20.5	20.5	33.5	33.5
		Weight	93	93	93	93	93	93	125	128	159	163	224	228	243	414	430	803	859
	UL Type 12 H6B2A□□□	Height	27.1	27.1	27.1	27.1	27.1	27.1	34.1	34.1	37.3	37.3	43.6	43.6	43.6	55.0	55.0	85.4	85.4
		Width	18.3	18.3	18.3	18.3	18.3	18.3	19.3	19.3	24.5	24.5	26.3	26.3	26.3	33.3	33.3	41.3	41.3
		Depth	18.8	18.8	18.8	18.8	18.8	18.8	18.9	18.9	19.0	19.0	21.4	21.4	21.4	26.3	26.3	34.4	34.4
		Weight	104	104	104	104	104	104	131	134	184	187	261	261	279	478	497	831	867
	UL Type 3R H6B3A□□□	Height	39.2	39.2	39.2	39.2	39.2	39.2	39.2	39.2	44.2	44.2	49.2	49.2	49.2	61.2	61.2	92.6	92.6
		Width	18.6	18.6	18.6	18.6	18.6	18.6	18.6	18.6	20.6	20.6	26.6	26.6	26.6	38.6	38.6	43.6	43.6
		Depth	18.1	18.1	18.1	18.1	18.1	18.1	18.1	18.1	20.1	20.1	22.1	22.1	22.1	25.1	25.1	48.6	48.6
		Weight	150	150	150	150	150	150	154	156	176	181	285	285	304	545	563	1019	1055

480 VAC MODELS

Base No. : H6B□B□□□		001	002	003	004	007	011	014	021	027	034	040	052	065	077	096	124	156	180	240	302				
Rated Output Current (A)		1.6	2.1	3.4	4.8	7.6	11	14	21	27	34	40	52	65	77	96	124	156	180	240	302				
Nominal HP		0.75	1	2	3	5	7.5	10	15	20	25	30	40	50	60	75	100	125	150	200	250				
Physical Size	UL Type 1 H6B1B□□□	Height	25.9	25.9	25.9	25.9	25.9	25.9	25.9	33.9	33.9	33.9	37.1	37.1	37.1	42.1	42.1	42.1	53.1	53.1	87.0	87.0			
		Width	15.7	15.7	15.7	15.7	15.7	15.7	15.7	15.7	18.7	18.7	18.7	18.7	18.7	18.7	20.8	20.8	20.8	25.6	25.6	25.6	33.8	42.0	42.0
		Depth	15.6	15.6	15.6	15.6	15.6	15.6	15.6	15.6	17.6	17.6	17.6	17.6	17.6	18.5	18.5	18.5	18.9	18.9	18.9	20.5	33.5	33.5	
		Weight	93	93	93	93	94	94	94	94	125	129	137	162	168	179	233	247	263	431	803	857	964		
	UL Type 12 H6B2B□□□	Height	27.1	27.1	27.1	27.1	27.1	27.1	27.1	34.1	34.1	34.1	37.3	37.3	37.3	43.6	43.6	43.6	55.0	55.0	85.4	85.4			
		Width	18.3	18.3	18.3	18.3	18.3	18.3	18.3	19.3	19.3	19.3	24.5	24.5	24.5	26.3	26.3	26.3	33.3	33.3	41.3	41.3			
		Depth	18.8	18.8	18.8	18.8	18.8	18.8	18.8	18.9	18.9	18.9	19.0	19.0	19.0	21.4	21.4	21.4	26.3	26.3	34.4	34.4			
		Weight	106	106	106	106	106	113	113	139	142	153	190	196	207	279	290	301	503	833	865	953			
	UL Type 3R H6B3B□□□	Height	39.2	39.2	39.2	39.2	39.2	39.2	39.2	39.2	39.2	39.2	44.2	44.2	44.2	49.2	49.2	49.2	61.2	61.2	92.6	92.6			
		Width	18.6	18.6	18.6	18.6	18.6	18.6	18.6	18.6	18.6	18.6	20.6	20.6	20.6	26.6	26.6	26.6	38.6	38.6	43.6	43.6			
		Depth	18.1	18.1	18.1	18.1	18.1	18.1	18.1	18.1	18.1	18.1	20.1	20.1	20.1	22.1	22.1	22.1	25.1	25.1	48.6	48.6			
		Weight	152	152	152	152	152	152	152	155	158	164	178	185	200	290	307	320	567	1014	1057	1163			

BYPASS SCHEMATIC

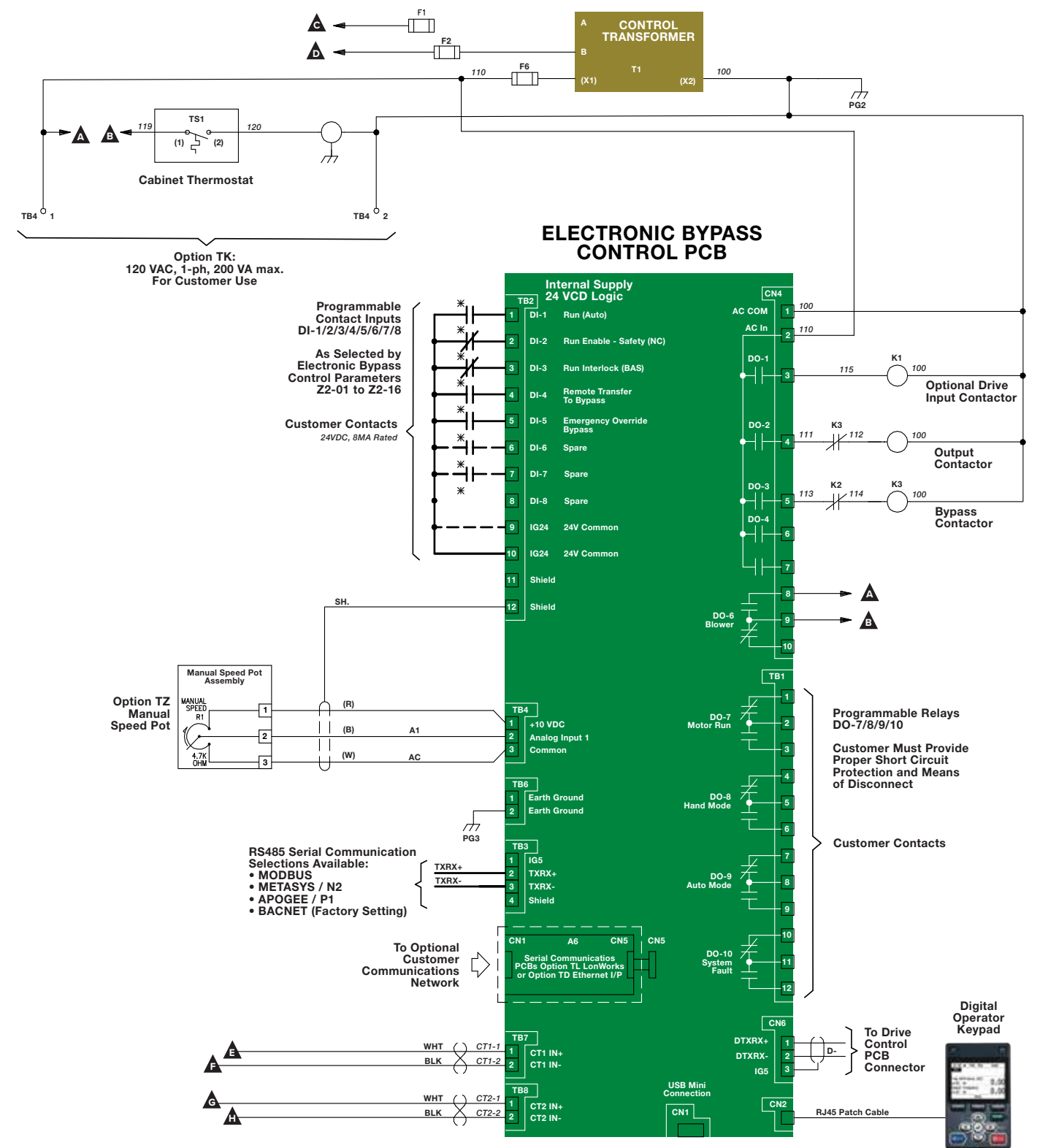
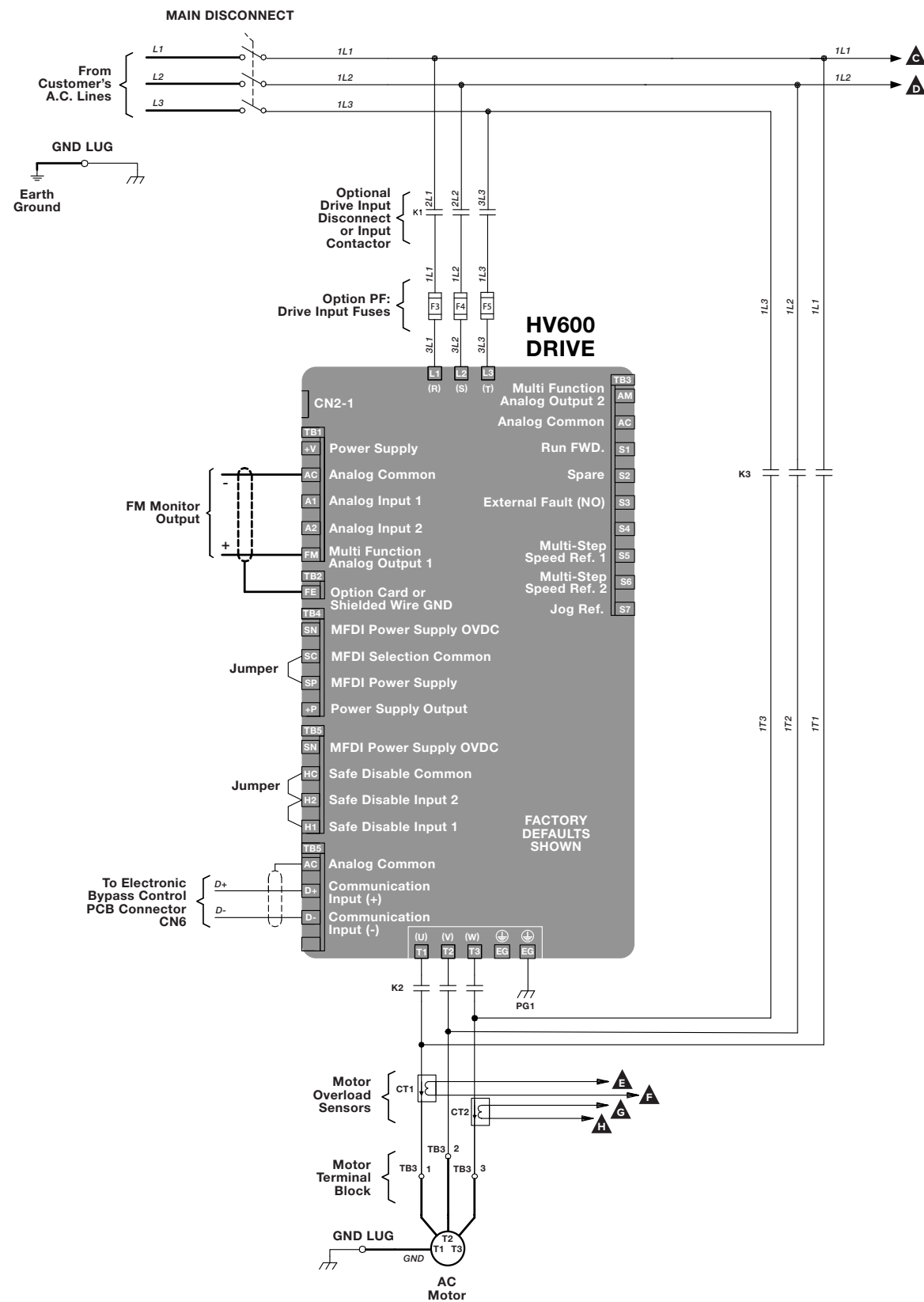

HV600 NARROW CONFIGURED

HV600 drive packages with features and options to fit specific application needs

HOW TO SELECT AN HV600 NARROW CONFIGURED PACKAGE

To construct a Narrow Bypass model number, find the base number for the required enclosure type, voltage, and current rating. Add the option code for each required option. Power options are preceded by 'P', control options are preceded by 'T'.

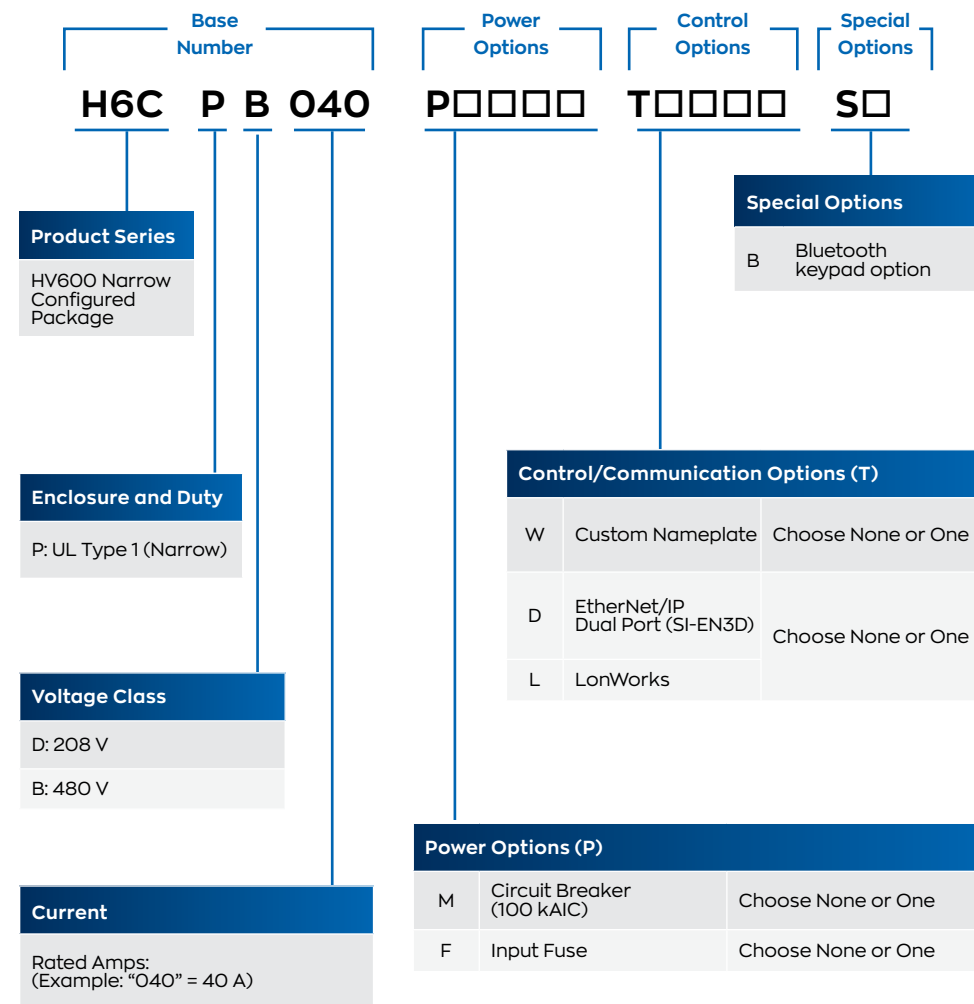

Note: Contact Yaskawa representative for possible exclusions.



FEATURES

- Lockable main input disconnect switch
- PID control with selectable engineering units
- Independent PID control for use with external device
- Differential PID feedback feature
- Sleep function
- 24 VDC, 150 mA power supply
- Input and output status indication
- Serial communication loss detection and selectable response
- Built-in communications
 - BACnet
 - APOGEE
 - Metasys
 - Modbus
- HOA keypad
- Flash upgradeable firmware
- Bumpless transfer between Hand and Auto modes
- Emergency Override

OPTIONS

- Circuit breaker: 100 kAIC
- Input fuses
- Custom nameplate
- LonWorks
- EtherNet/IP
- Bluetooth HOA keypad

Models and Ratings

208 VAC MODELS

Base No.: H6CPD□□□		002	003	004	007	010	016	024	030	046	059	074	088	114	
Rated Output Current (A)		2.4	3.5	4.6	7.5	10.6	16.7	24.2	30.8	46.2	59.4	74.8	88	114	
Nominal HP		0.5	0.75	1	2	3	5	7.5	10	15	20	25	30	40	
Physical Size	UL Type 1 H6CPD□□□	Height	33.0	33.0	33.0	33.0	33.0	33.0	36.6	36.6	39.9	39.9	45.8	45.8	45.8
		Width	6.3	6.3	6.3	6.3	6.3	6.3	6.3	6.3	9.3	9.3	11.0	11.0	11.0
		Depth	13.9	13.9	13.9	13.9	13.9	13.9	13.9	13.9	14.2	14.2	15.1	15.1	15.1
		Weight	41	41	41	41	41	41	41	47	49	67	70	101	106

480 VAC MODELS

Base No.: H6CPB□□□		001	002	003	004	007	011	014	021	027	034	040	052	065	077	096	
Rated Output Current (A)		1.6	2.1	3.4	4.8	7.6	11	14	21	27	34	40	52	65	77	96	
Nominal HP		0.75	1	2	3	5	7.5	10	15	20	25	30	40	50	60	75	
Physical Size	UL Type 1 H6CPB□□□	Height	33.0	33.0	33.0	33.0	33.0	33.0	36.6	36.6	36.6	39.9	39.9	45.8	45.8	45.8	
		Width	6.3	6.3	6.3	6.3	6.3	6.3	6.3	6.3	6.3	9.0	9.0	11.0	11.0	11.0	
		Depth	13.9	13.9	13.9	13.9	13.9	13.9	13.9	13.9	13.9	13.9	14.2	14.2	15.1	15.1	15.1
		Weight	42	42	42	42	42	42	42	42	48	50	53	70	75	94	108

HV600 ENCLOSED CONFIGURED

HV600 drive packages with features and options to fit specific application needs.

HOW TO SELECT AN HV600 ENCLOSED CONFIGURED PACKAGE

To construct a Enclosed Configured model number, find the base number for the required enclosure type, voltage, and current rating. Add the option code for each required option. Power options are preceded by 'P', control options are preceded by 'T'.

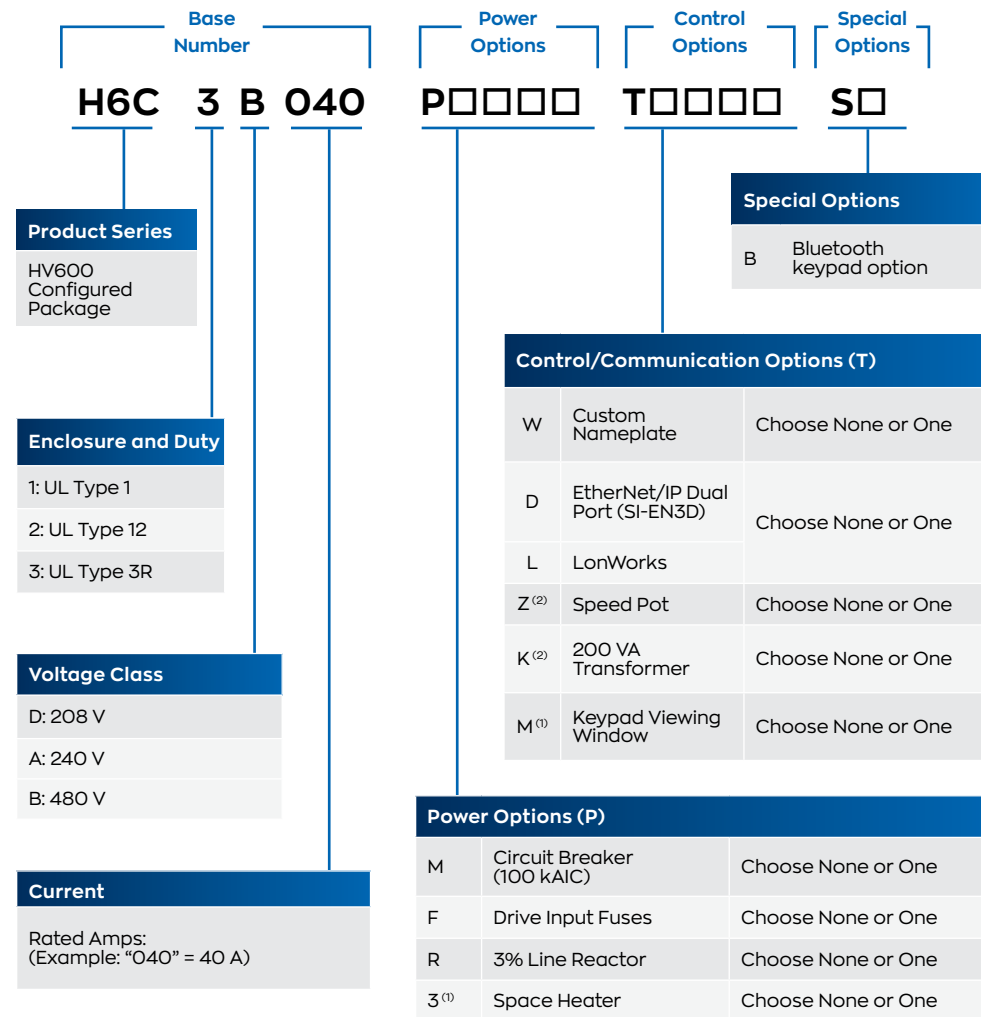

(1) Type 3R enclosures only.
(2) Type 12 enclosures only.

Note: Contact Yaskawa representative for possible exclusions.



Floor and Wall Mount Packages

FEATURES

- Lockable main input disconnect switch
- PID control with selectable engineering units
- Independent PID control for use with external device
- Differential PID feedback feature
- Sleep function
- 24 VDC, 150 mA power supply
- Input and output status indication
- Serial communication loss detection and selectable response
- Built-in communications
 - BACnet
 - APOGEE
 - Metasys
 - Modbus
- HOA keypad
- Flash upgradeable firmware
- Bumpless transfer between Hand and Auto modes
- Emergency override

OPTIONS

- Circuit Breaker
- Input fuses
- Line Reactor
- Custom nameplate
- LonWorks
- EtherNet/IP
- Speed pot
- 200 VA transformer
- Keypad viewing window
- Bluetooth HOA keypad

Models and Ratings

208 VAC MODELS

Base No. : H6C□□□□		002	003	004	007	010	016	024	030	046	059	074	088	114	143	169	211	273	
Rated Output Current (A)		2.4	3.5	4.6	7.5	10.6	16.7	24.2	30.8	46.2	59.4	74.8	88	114	143	169	211	273	
Nominal HP		0.5	0.75	1	2	3	5	7.5	10	15	20	25	30	40	50	60	75	100	
Physical Size	UL Type 1 H6C1D□□□	Height	25.9	25.9	25.9	25.9	25.9	25.9	33.9	33.9	37.1	37.1	42.1	42.1	42.1	53.1	53.1	87.0	87.0
		Width	15.7	15.7	15.7	15.7	15.7	15.7	18.7	18.7	20.8	20.8	25.6	25.6	25.6	33.8	33.8	42.0	42.0
		Depth	15.6	15.6	15.6	15.6	15.6	15.6	17.6	17.6	18.5	18.5	18.9	18.9	18.9	20.5	20.5	33.5	33.5
		Weight	90	90	90	90	91	92	124	133	166	170	221	228	240	422	432	449	515
	UL Type 12 H6C2D□□□	Height	27.1	27.1	27.1	27.1	27.1	27.1	34.1	34.1	37.3	37.3	43.6	43.6	43.6	55.0	55.0	85.4	85.4
		Width	18.3	18.3	18.3	18.3	18.3	18.3	19.3	19.3	24.5	24.5	26.3	26.3	26.3	33.3	33.3	41.3	41.3
		Depth	18.8	18.8	18.8	18.8	18.8	18.8	18.9	18.9	19.0	19.0	21.4	21.4	21.4	26.3	26.3	34.4	34.4
		Weight	97	97	97	97	101	102	125	137	180	188	258	261	273	475	480	477	544
	UL Type 3R H6C3D□□□	Height	39.2	39.2	39.2	39.2	39.2	39.2	39.2	39.2	44.2	44.2	49.2	49.2	49.2	61.2	61.2	92.6	92.6
		Width	18.6	18.6	18.6	18.6	18.6	18.6	18.6	18.6	20.6	20.6	26.6	26.6	26.6	38.6	38.6	43.6	43.6
		Depth	18.1	18.1	18.1	18.1	18.1	18.1	18.1	18.1	20.1	20.1	22.1	22.1	22.1	25.1	25.1	48.6	48.6
		Weight	150	150	150	150	150	152	156	164	188	194	287	293	305	548	557	1041	1092

240 VAC MODELS

Base No. : H6C□A□□□		002	003	004	006	009	015	022	028	042	054	068	080	104	130	154	192	248	
Rated Output Current (A)		2.2	3.2	4.2	6.8	9.6	15.2	22	28	42	54	68	80	104	130	154	192	248	
Nominal HP		0.5	0.75	1	2	3	5	7.5	10	15	20	25	30	40	50	60	75	100	
Physical Size	UL Type 1 H6C1A□□□	Height	25.9	25.9	25.9	25.9	25.9	25.9	33.9	33.9	37.1	37.1	42.1	42.1	42.1	53.1	53.1	87.0	87.0
		Width	15.7	15.7	15.7	15.7	15.7	15.7	18.7	18.7	20.8	20.8	25.6	25.6	25.6	33.8	33.8	42.0	42.0
		Depth	15.6	15.6	15.6	15.6	15.6	15.6	17.6	17.6	18.5	18.5	18.9	18.9	18.9	20.5	20.5	33.5	33.5
		Weight	89	89	91	91	91	92	124	128	161	169	220	225	236	412	431	447	469
	UL Type 12 H6C2A□□□	Height	27.1	27.1	27.1	27.1	27.1	27.1	34.1	34.1	37.3	37.3	43.6	43.6	43.6	55.0	55.0	85.4	85.4
		Width	18.3	18.3	18.3	18.3	18.3	18.3	19.3	19.3	24.5	24.5	26.3	26.3	26.3	33.3	33.3	41.3	41.3
		Depth	18.8	18.8	18.8	18.8	18.8	18.8	18.9	18.9	19.0	19.0	21.4	21.4	21.4	26.3	26.3	34.4	34.4
		Weight	96	96	97	99	98	98	125	128	175	187	252	254	268	464	479	476	500
	UL Type 3R H6C3A□□□	Height	39.2	39.2	39.2	39.2	39.2	39.2	39.2	39.2	44.2	44.2	49.2	49.2	49.2	61.2	61.2	92.6	92.6
		Width	18.6	18.6	18.6	18.6	18.6	18.6	18.6	18.6	20.6	20.6	26.6	26.6	26.6	38.6	38.6	43.6	43.6
		Depth	18.1	18.1	18.1	18.1	18.1	18.1	18.1	18.1	20.1	20.1	22.1	22.1	22.1	25.1	25.1	48.6	48.6
		Weight	150	150	150	150	150	150	156	159	184	193	285	287	300	535	555	1014	1049

480 VAC MODELS

Base No. : H6C□B□□□		001	002	003	004	007	011	014	021	027	034	040	052	065	077	096	124	156	180	240	302	
Rated Output Current (A)		1.6	2.1	3.4	4.8	7.6	11	14	21	27	34	40	52	65	77	96	124	156	180	240	302	
Nominal HP		0.75	1	2	3	5	7.5	10	15	20	25	30	40	50	60	75	100	125	150	200	250	
Physical Size	UL Type 1 H6C1B□□□	Height	25.9	25.9	25.9	25.9	25.9	25.9	25.9	33.9	33.9	37.1	37.1	37.1	42.1	42.1	42.1	53.1	53.1	53.1	87.0	
		Width	15.7	15.7	15.7	15.7	15.7	15.7	15.7	18.7	18.7	18.7	20.8	20.8	20.8	25.6	25.6	25.6	33.8	33.8	33.8	42.0
		Depth	15.6	15.6	15.6	15.6	15.6	15.6	15.6	17.6	17.6	17.6	18.5	18.5	18.5	18.9	18.9	18.9	20.5	20.5	20.5	33.5
		Weight	90	91	91	91	92	93	99	131	133	139	163	175	183	237	245	264	439	463	490	980
	UL Type 12 H6C2B□□□	Height	27.1	27.1	27.1	27.1	27.1	27.1	27.1	34.1	34.1	34.1	37.3	37.3	37.3	43.6	43.6	43.6	55.0	55.0	55.0	85.4
		Width	18.3	18.3	18.3	18.3	18.3	18.3	18.3	19.3	19.3	19.3	24.5	24.5	24.5	26.3	26.3	26.3	33.3	33.3	33.3	41.3
		Depth	18.8	18.8	18.8	18.8	18.8	18.8	18.8	18.9	18.9	18.9	19.0	19.0	19.0	21.4	21.4	21.4	26.3	26.3	26.3	34.4
		Weight	100	100	100	100	100	100	100	134	135	145	181	193	200	272	276	295	490	494	525	933
	UL Type 3R H6C3B□□□	Height	39.2	39.2	39.2	39.2	39.2	39.2	39.2	39.2	39.2	39.2	44.2	44.2	44.2	49.2	49.2	49.2	61.2	61.2	92.6	92.6
		Width	18.6	18.6	18.6	18.6	18.6	18.6	18.6	18.6	18.6	18.6	20.6	20.6	20.6	26.6	26.6	26.6	38.6	38.6	43.6	43.6
		Depth	18.1	18.1	18.1	18.1	18.1	18.1	18.1	18.1	18.1	18.1	20.1	20.1	20.1	22.1	22.1	22.1	25.1	25.1	48.6	48.6
		Weight	151	151	151	151	155	155	159	163	165	171	185	198	205	300	308	334	566	1026	1070	1189

HVAC MATRIX DRIVE

Z1000U



Increase your green space with the Yaskawa Z1000U HVAC Matrix Drive, the product that goes beyond conventional drives by combining excellent harmonic mitigation, input power factor control and energy saving capabilities.

The Z1000U HVAC Matrix drive provides extremely low harmonic distortion in a space-saving design, along with the same HVAC-specific features as the standard HV600. This single-component solution achieves excellent low distortion levels without the need for harmonics mitigation, such as passive filters or multi-pulse arrangements. Unlike conventional drives, Yaskawa's Matrix technology creates a variable output by switching directly from the AC input power, thus eliminating the DC bus. The Matrix drive's outstanding harmonic performance helps system designers achieve harmonics performance levels well within the recommended practice of IEEE 519.



APPLICATIONS

- Supply & return fans
- Cooling tower fans
- Chilled water pumps
- Chiller compressors

POWER RANGE

- 10-100 HP, 208 V
- 7.5-350 HP, 480 V

AVAILABLE PACKAGES

- Bypass
- Configured

ENCLOSURES

- Open Type (IPO0)
- UL Type 1 Kit

PRIMARY FEATURES AND BENEFITS

- Low input distortion across a wide load and speed range
- < 5% THD
- Eco-mode to achieve near across-the-line THD
- High efficiency design provides extra energy savings as compared to other low harmonic solutions
- Near unity True Power Factor at full load
- 0.98 Displacement Power Factor throughout entire load and speed range
- Integrated Input Fusing provides 100kA SCCR
- Integrated C2 EMC filter
- Compact design
- High reliability with an MTBF of 28 years
- Embedded BACnet Communications (BTL Certified)
- Embedded Real Time Clock for event stamping
- High Carrier Frequency (Low Motor Noise) capability
- 0-400 Hz output frequency
- 120% overload for 60 seconds
- Motor auto-tuning
- Multi-language LCD display, with Hand/Off/Auto and copy function
- DriveWizard® HVAC software
- Embedded Timer functions for starting, stopping and speed changes
- Start into spinning load (speed search)
- Both Induction and Permanent Magnet motor control
- Available I/O
 - (8) Multi-function digital inputs
 - (3) Multi-function analog inputs
 - (3) Multi-function relay outputs
 - (2) Multi-function 0-10 VDC or 4-20 mA analog outputs
 - (1) Fault relay

Model Number Designation

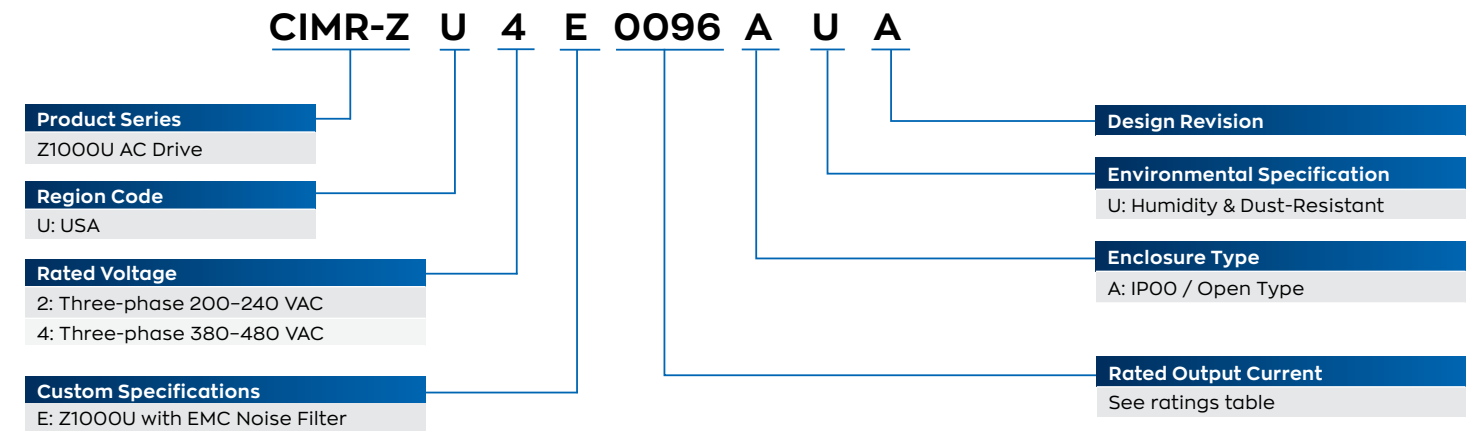

Models and Ratings

208 V MODELS

CIMR-ZU2E □□□□ AUA		0028	0042	0054	0068	0081	0104	0130	0154	0192	0248
Rated Output Current (A)		28	42	54	68	81	104	130	154	192	248
Nominal HP 240V (208V)		10 (7.5)	15 (10)	20 (15)	25 (20)	30 (25)	40 (30)	50 (40)	60 (50)	75 (60)	100 (75)
Dim (in)	Height	19	26	26	26	26	32	32	39	39	45
	Width	10	10	10	10	10	10	10	16	16	19
	Depth	14	17	17	17	17	18	18	16	16	18
Weight (lb)		46	73	73	79	79	139	139	254	254	399
Heat Loss (W)	Heatsink	659	854	1037	1295	1420	1696	2157	2441	3064	3785
	Internal	103	168	195	225	238	282	341	366	447	578
	Total	762	1022	1232	1520	1658	1978	2498	2807	3511	4363

480 V MODELS

CIMR-ZU4E □□□□ AUA		0011	0014	0021	0027	0034	0040	0052	0065	0077
Rated Output Current (A)		11	14	21	27	34	40	52	65	77
Nominal HP		7.5	10	15	20	25	30	40	50	60
Dim (in)	Height	19	19	19	19	19	26	26	26	26
	Width	10	10	10	10	10	10	10	10	10
	Depth	14	14	14	14	14	17	17	17	17
Weight (lb)		46	46	46	46	46	73	73	79	79
Heat Loss (W)	Heatsink	452	459	641	675	798	877	1109	1369	1479
	Internal	80	79	105	106	124	174	209	240	251
	Total	532	538	746	781	922	1051	1318	1609	1730

CIMR-ZU4E □□□□ AUA		0096	0124	0156	0180	0216	0240	0302	0361	0414
Rated Output Current (A)		96	124	156	180	216	240	302	361	414
Nominal HP		75	100	125	150	175	200	250	300	350
Dim (in)	Height	32	32	39	39	45	45	45	45	45
	Width	10	10	16	16	19	19	27	27	27
	Depth	18	18	16	16	18	18	18	18	18
Weight (lb)		139	139	254	254	399	399	589	589	589
Heat Loss (W)	Heatsink	1715	2256	2857	3316	3720	3897	5202	5434	6444
	Internal	290	362	421	482	587	600	857	863	1012
	Total	2005	2618	3278	3798	4307	4497	6059	6297	7456

Note: Data subject to change.

HVAC SOFTWARE TOOLS

Yaskawa's collection of HVAC software support tools can be used to upload and download drive parameters, calculate energy savings, or identify how to reduce your operating costs and meet harmonic compliance requirements

DRIVEWIZARD® HVAC

Innovative software tool that allows users to commission, start up and diagnose the Yaskawa family of HVAC drives quickly and easily. Built-in features include a monitor panel, status panel, 16-channel trend recorder, and application wizard. Easily convert settings of previous generation Yaskawa HVAC drives to the HV600 drive.

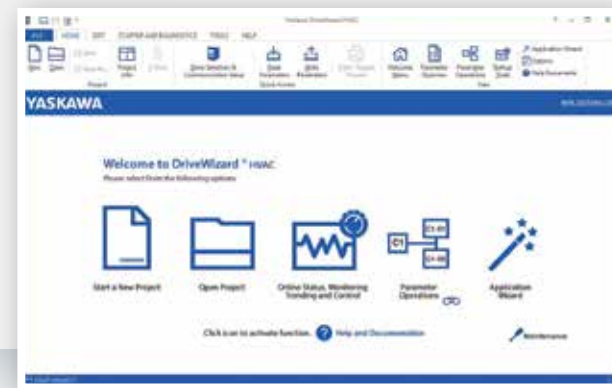

DRIVEWIZARD® MOBILE WITH YASKAWA DRIVE CLOUD

Start-up, adjust, and monitor Yaskawa's HV600 with your smartphone or tablet. Use DriveWizard Mobile to backup, store, and retrieve your drive settings locally or to your personal Yaskawa Drive Cloud account.



DRIVEWORKSEZ

Software tool that provides the means to create custom logic and mathematic functionality inside the HV600. This functionality is built-in to the HV600 drive. Simply create application programs by arranging function block icons in a visual flow chart. Total drive and machine control are only a few mouse clicks away

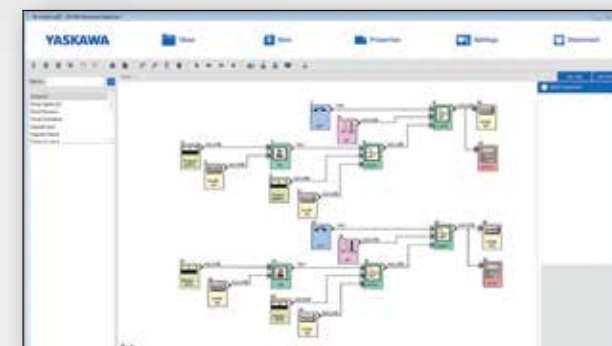

ENERGY SAVINGS PREDICTOR

Predicts energy savings achieved when using Yaskawa HVAC drives instead of conventional control methods in HVAC applications. The results can be viewed in graphical and text format with built-in functions to generate an energy prediction report, especially designed for consultants.

HARMONICS ESTIMATOR

Estimates total harmonic distortion when using Yaskawa HVAC drives and references IEEE 519 to determine if the defined system meets the required standard. The results can be viewed in graphical and text format with built-in functions to generate an energy prediction report especially designed for consultants.



PROGRAMMING SIMULATORS

Provide a realistic simulation of the programming and operation of an HV600 or HV600 Bypass package. All major functions of the drives are simulated by these PC tools with the addition of I/O, trending, diagnostic operations. The software has an integrated automatic update function that allows for updating the actual program - when connected to the internet.

ENGINEERING & SUPPORT



Engineered Panel

ENGINEERING CAPABILITY

Yaskawa has the engineering capability to design and build UL508A control panels to meet any customer needs. Fan array control panels, redundant drive panels, and multi-pulse arrangements with a wide range of accessories and options can be quoted and delivered in minimal time. Let Yaskawa deliver per your specific needs.

TECHNICAL TRAINING

Both standard and customized courses are available with hands-on activities and demonstrations. Instruction is offered at Yaskawa locations as well as traveling road schools, and is supplemented by live web classes and e-Learning modules / videos to provide the right level of training to fit your needs. Trainers are degreed engineers with extensive industry experience who train over 3,000 customers worldwide each year, with thousands more viewing learning modules online.



Traveling Road Show Van

YASKAWA SOLUTION CENTER

The Yaskawa Solution Center is a web portal for learning about all things Yaskawa. More specifically, it is designed to help customers get specific support for their product questions and needs.

We recognize that our customers may not want to get help only by phone. That's why we created the Yaskawa Solution Center, an online tool to readily find resources for things like:

- Step-by-step instructions, including video tutorials
- Help configuring a product for a new application
- Starting up a product for the first time
- Transitioning from an older legacy product to a current one

This information is delivered via technical documents and manuals, video, and authored content based on real case scenarios in real time.

The Solutions Center also includes a crowd-sourcing feature. By allowing all visitors to provide feedback on anything they find on the site, we can improve, correct and add content. Even Yaskawa sales associates continuously submit feedback to content based on what they see and learn in the field. The site is literally updated in real time!

All of this collaboration between Yaskawa associates, distributors, OEMs and end-users makes the Solution Center more and more valuable to our customers every day.



Crowd-Sourcing Feature
Content is continuously added and updated in real time.

WORLDWIDE CUSTOMER SUPPORT

Yaskawa offers worldwide support with application assistance, start up, maintenance, troubleshooting and repair, as well as internet tools and telephone support. Sales and service offices are located around the world.

SUPPORT AVAILABLE

24/7/365

In the Americas, telephone assistance is available 24/7/365 at 1-800-YASKAWA (927-5292). Our phone support group is product certified to assist you with current and legacy drive requirements.

Yaskawa's Field Service personnel and local Authorized Service Providers can provide on-site start-up assistance, troubleshooting, and repair. Same day exchange units or fast turnaround repairs are available.



The Customer Relationship Management Institute has honored Yaskawa with the NorthFace ScoreBoard Award eight years running for excellence in technical support.

VISIT [HTTPS://SOLUTIONCENTER.YASKAWA.COM/](https://solutioncenter.yaskawa.com/)

Bridging the gap between what you are trying to do and the technical information you need to accomplish it.

Videos
Easy-to-use and follow instructional videos.

User Manuals
Online access to instructions on how to install, operate and troubleshoot.

Technical Documents
Complete library of parts and specs for our products.



YASKAWA.COM



Yaskawa is the leading global manufacturer of low and medium voltage variable frequency drives, servo systems, machine controllers and industrial robots. Our standard products, as well as tailor-made solutions, are well known and have a high reputation for outstanding quality and reliability.

YASKAWA

Yaskawa America, Inc. | Drives & Motion Division

1-800-YASKAWA | Email: info@yaskawa.com | yaskawa.com

Document No. BL.HV600.01 | 08/26/2021 | © 2021 Yaskawa America, Inc.