

AC Servo Drives
 Σ -V Series
USER'S MANUAL
Design and Maintenance
Rotational Motor
Command Option Attachable Type

SGDV SERVOPACK
SGMJV/SGMAV/SGMPS/SGMGV/SGMSV/SGMCS Servomotors

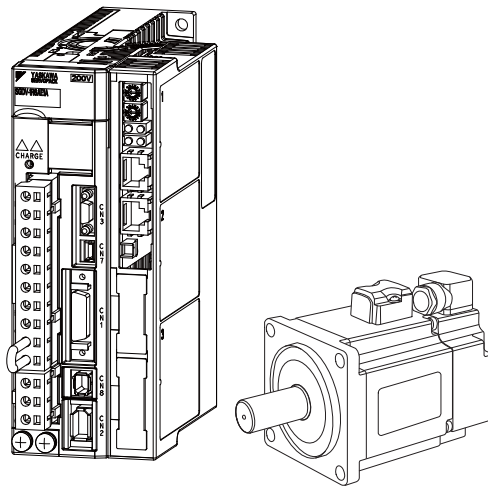

Outline	1
Panel Display and Operation of Digital Operator	2
Wiring and Connection	3
Operation	4
Adjustments	5
Utility Functions (Fn□□□)	6
Monitor Modes (Un□□□)	7
Fully-closed Loop Control	8
Troubleshooting	9
Appendix	10

Copyright © 2009 YASKAWA ELECTRIC CORPORATION

All rights reserved. No part of this publication may be reproduced, stored in a retrieval system, or transmitted, in any form, or by any means, mechanical, electronic, photocopying, recording, or otherwise, without the prior written permission of Yaskawa. No patent liability is assumed with respect to the use of the information contained herein. Moreover, because Yaskawa is constantly striving to improve its high-quality products, the information contained in this manual is subject to change without notice. Every precaution has been taken in the preparation of this manual. Nevertheless, Yaskawa assumes no responsibility for errors or omissions. Neither is any liability assumed for damages resulting from the use of the information contained in this publication.

About this Manual

This manual describes informations required for designing, and maintaining Σ -V Series SERVOPACKs.

Be sure to refer to this manual and perform design and maintenance to select devices correctly.

Keep this manual in a location where it can be accessed for reference whenever required.

■ Description of Technical Terms

The following table shows the meanings of terms used in this manual.

Term	Meaning
Cursor	A mark that indicates the input position of data displayed on the digital operator
Servomotor	Σ -V Series SGMJV, SGMVA, SGMPS, SGMGV, SGMV, or SGMCS (Direct Drive) servomotor
SERVOPACK	Σ -V Series SGD servo amplifier of command option attachable type
Servo drive	A set including a servomotor and SERVOPACK (i.e., a servo amplifier)
Servo System	A servo control system that includes the combination of a servo drive with a host controller and peripheral devices
Servo ON	When power is being supplied to the servomotor
Servo OFF	When power is not being supplied to the servomotor
Base block	Turning OFF the power by shutting OFF the base current of the IGBT for the current amplifier

■ IMPORTANT Explanations

The following icon is displayed for explanations requiring special attention.



IMPORTANT

- Indicates important information that should be memorized, as well as precautions, such as alarm displays, that do not involve potential damage to equipment.

■ Notation Used in this Manual

• Reverse Symbol Notation

In this manual, the names of reverse signals (ones that are valid when low) are written with a forward slash (/) before the signal name, as shown in the following example:

Example

The notation for $\overline{\text{BK}}$ is /BK.

• Parameter Notation

The following two types of notations are used for parameter digit places and settings.

Example

Digital Operator Display

Pn000 = n . 0 0 0 0

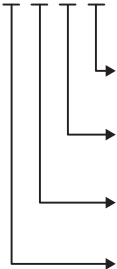

Notation Example for Pn000

Digit Notation		Set Value Notation	
Notation Method	Meaning	Notation Method	Meaning
Pn000.0	Indicates digit 1 of the parameter (Pn000).	Pn000.0 = x or n.□□□x	Indicates that digit 1 of the parameter (Pn000) is x.
Pn000.1	Indicates digit 2 of the parameter (Pn000).	Pn000.1 = x or n.□□x□	Indicates that digit 2 of the parameter (Pn000) is x.
Pn000.2	Indicates digit 3 of the parameter (Pn000).	Pn000.2 = x or n.□x□□	Indicates that digit 3 of the parameter (Pn000) is x.
Pn000.3	Indicates digit 4 of the parameter (Pn000).	Pn000.3 = x or n.x□□□	Indicates that digit 4 of the parameter (Pn000) is x.

■ **Manuals Related to the Σ -V Series**

Refer to the following manuals as required.

Name	Selecting Models and Peripheral Devices	Ratings and Specifications	Panels and Wiring	Trial Operation	Trial Operation and Servo Adjustment	Maintenance and Inspection
Σ -V Series User's Manual Indexer Module (SIEP C720829 02)		✓		✓	✓	✓
Σ -V Series User's Manual Safety Module (SIEP C720829 06)		✓		✓	✓	✓
Σ -V Series User's Manual Setup Rotational Motor (SIEP S800000 43)			✓	✓		
Σ -V Series Product Catalog (KAEP S800000 42)	✓	✓				
Σ -V Series User's Manual Operation of Digital Operator (SIEP S800000 55)				✓	✓	✓
Σ -V Series AC SERVOPACK SGDV Safety Precautions (TOBP C710800 10)	✓		✓			✓
Σ Series Digital Operator Safety Precautions (TOBP C730800 00)						✓
AC SERVOMOTOR Safety Precautions (TOBP C230200 00)			✓			✓

■ Safety Information

The following conventions are used to indicate precautions in this manual. Failure to heed precautions provided in this manual can result in serious or possibly even fatal injury or damage to the products or to related equipment and systems.



Indicates precautions that, if not heeded, could possibly result in loss of life or serious injury.



Indicates precautions that, if not heeded, could result in relatively serious or minor injury, damage to the product, or faulty operation. In some situations, the precautions indicated could have serious consequences if not heeded.



Indicates prohibited actions that must not be performed. For example, this symbol would be used to indicate that fire is prohibited as follows:





Indicates compulsory actions that must be performed. For example, this symbol would be used as follows to indicate that grounding is compulsory:



Safety Precautions

These safety precautions are very important. Read them before performing any procedures such as storage and transportation, installation, wiring, operation and inspection, or disposal. Be sure to always observe these precautions thoroughly.

WARNING

- Never touch any rotating motor parts while the motor is running.
Failure to observe this warning may result in injury.
- Before starting operation with a machine connected, make sure that an emergency stop can be applied at any time.
Failure to observe this warning may result in injury or damage to the product.
- Never touch the inside of the SERVOPACKs.
Failure to observe this warning may result in electric shock.
- Do not remove the cover of the power supply terminal block while the power is ON.
Failure to observe this warning may result in electric shock.
- After the power is turned OFF or after a voltage resistance test, do not touch terminals while the charge indicator is ON.
Residual voltage may cause electric shock.
- Follow the procedures and instructions provided in this manual for trial operation.
Failure to do so may result not only in faulty operation and damage to equipment, but also in personal injury.
- The multi-turn serial data output range for the Σ -V Series absolute position detecting system is different from that of earlier systems with 15-bit and 12-bit encoders. In particular, change the system to configure the Σ Series infinite-length positioning system with the Σ -V Series.
- The multi-turn limit value need not be changed except for special applications.
Changing it inappropriately or unintentionally can be dangerous.
- If the Multi-turn Limit Disagreement alarm occurs, check the setting of parameter Pn205 in the SERVOPACK to be sure that it is correct.
If Fn013 is executed when an incorrect parameter value is set, an incorrect value will be set in the encoder. The alarm will disappear even if an incorrect value is set, but incorrect positions will be detected, resulting in a dangerous situation where the machine will move to unexpected positions.
- Do not remove the front cover, cables, connectors, or optional items from the upper front of the SERVOPACK while the power is ON.
Failure to observe this warning may result in electric shock.
- Do not damage, press, exert excessive force on, or place heavy objects on the cables.
Failure to observe this warning may result in electric shock, stopping operation of the product, or fire.
- Provide an appropriate braking devices on the machine side to ensure safety. The holding brake on a servomotor with a brake is not a braking device for ensuring safety.
Failure to observe this warning may result in injury.
-  Connect the ground terminal according to local electrical codes (100 Ω or less for a SERVOPACK with a 100 V, 200 V power supply, 10 Ω or less for a SERVOPACK with a 400 V power supply).
Improper grounding may result in electric shock or fire.
-  Installation, disassembly, or repair must be performed only by authorized personnel.
Failure to observe this warning may result in electric shock or injury.
- The person who designs a system using the safety function (Hard Wire Baseblock function) must have full knowledge of the related safety standards and full understanding of the instructions in this manual.
Failure to observe this warning may result in injury.

■ Storage and Transportation

CAUTION

- Do not store or install the product in the following locations.
Failure to observe this caution may result in fire, electric shock, or damage to the product.
 - Locations subject to direct sunlight
 - Locations subject to ambient operating temperatures outside the range specified in the storage/installation temperature conditions
 - Locations subject to humidity outside the range specified in the storage/installation humidity conditions
 - Locations subject to condensation as the result of extreme changes in temperature
 - Locations subject to corrosive or flammable gases
 - Locations subject to dust, salts, or iron dust
 - Locations subject to exposure to water, oil, or chemicals
 - Locations subject to shock or vibration
- Do not hold the product by the cables, motor shaft or detector while transporting it.
Failure to observe this caution may result in injury or malfunction.
- Do not place any load exceeding the limit specified on the packing box.
Failure to observe this caution may result in injury or malfunction.
- If disinfectants or insecticides must be used to treat packing materials such as wooden frames, pallets, or plywood, the packing materials must be treated before the product is packaged, and methods other than fumigation must be used.
Example: Heat treatment, where materials are kiln-dried to a core temperature of 56°C for 30 minutes or more.
If the electronic products, which include stand-alone products and products installed in machines, are packed with fumigated wooden materials, the electrical components may be greatly damaged by the gases or fumes resulting from the fumigation process. In particular, disinfectants containing halogen, which includes chlorine, fluorine, bromine, or iodine can contribute to the erosion of the capacitors.

■ Installation

CAUTION

- Never use the product in an environment subject to water, corrosive gases, inflammable gases, or combustibles.
Failure to observe this caution may result in electric shock or fire.
- Do not step on or place a heavy object on the product.
Failure to observe this caution may result in injury.
- Do not cover the inlet or outlet ports and prevent any foreign objects from entering the product.
Failure to observe this caution may cause internal elements to deteriorate resulting in malfunction or fire.
- Be sure to install the product in the correct direction.
Failure to observe this caution may result in malfunction.
- Provide the specified clearances between the SERVOPACK and the control panel or with other devices.
Failure to observe this caution may result in fire or malfunction.
- Do not apply any strong impact.
Failure to observe this caution may result in malfunction.

■ Wiring



CAUTION

- Be sure to wire correctly and securely.
Failure to observe this caution may result in motor overrun, injury, or malfunction.
- Do not connect a commercial power supply to the U, V, or W terminals for the servomotor connection.
Failure to observe this caution may result in injury or fire.
- Securely connect the main circuit power supply terminal screws, control power supply terminal screws, and servomotor connection terminal screws.
Failure to observe this caution may result in fire.
- Do not bundle or run the main circuit cables together with the input/output signal cables or the encoder cables in the same duct. Keep them separated by at least 30 cm.
Failure to do so may result in malfunction.
- Use shielded twisted-pair wires or multi-core shielded twisted-pair wires for input/output signal cables and the encoder cables.
- I/O signal cables must be no longer than 3 m, encoder cables must be no longer than 50 m, and control power supply cables for the SERVOPACK with a 400 V power supply (+24 V, 0 V) must be no longer than 10 m.
- Do not touch the power terminals while the charge indicator is ON after turning power OFF because high voltage may still remain in the SERVOPACK.
Make sure the charge indicator is off first before starting an inspection.
- Observe the following precautions when wiring main circuit terminal blocks of the SERVOPACK.
 - Remove the detachable main circuit terminal blocks from the SERVOPACK prior to wiring.
 - Insert only one main power line per opening in the main circuit terminals.
 - Make sure that no part of the core wire comes into contact with (i.e., short-circuit) adjacent wires.
- Install a battery at either the host controller or the SERVOPACK, but not both.
It is dangerous to install batteries at both ends simultaneously, because that sets up a loop circuit between the batteries.
- Always use the specified power supply voltage.
An incorrect voltage may result in fire or malfunction.
- Take appropriate measures to ensure that the input power supply is supplied within the specified voltage fluctuation range. Be particularly careful in places where the power supply is unstable.
An incorrect power supply may result in damage to the product.
- Install external breakers or other safety devices against short-circuiting in external wiring.
Failure to observe this caution may result in fire.
- Take appropriate and sufficient countermeasures for each form of potential interference when installing systems in the following locations.
 - Locations subject to static electricity or other forms of noise
 - Locations subject to strong electromagnetic fields and magnetic fields
 - Locations subject to possible exposure to radioactivity
 - Locations close to power suppliesFailure to observe this caution may result in damage to the product.
- Do not reverse the polarity of the battery when connecting it.
Failure to observe this caution may damage the battery, the SERVOPACK, the servomotor, or cause an explosion.
- Wiring or inspection must be performed by a technical expert.
- Use a 24-VDC power supply with double insulation or reinforced insulation.

■ Operation

CAUTION

- Always use the servomotor and SERVOPACK in one of the specified combinations.
Failure to observe this caution so may result in fire or malfunction.
- Conduct trial operation on the servomotor alone with the motor shaft disconnected from the machine to avoid accidents.
Failure to observe this caution may result in injury.
- During trial operation, confirm that the holding brake works correctly. Furthermore, secure system safety against problems such as signal line disconnection.
Failure to observe this caution may result in damage to the equipment or injury.
- Before starting operation with a machine connected, change the settings to match the parameters of the machine.
Starting operation without matching the proper settings may cause the machine to run out of control or malfunction.
- Do not frequently turn power ON and OFF.
Since the SERVOPACK has a capacitor in the power supply, a high charging current flows when power is turned ON. Frequently turning power ON and OFF causes main power devices like capacitors and fuses to deteriorate, resulting in unexpected problems.
- When using JOG operations (Fn002), search operations (Fn003), or EasyFFT operations (Fn206), the dynamic brake function does not work for reverse overtravel or forward overtravel. Take necessary precautions.
- When using the servomotor for a vertical axis, install safety devices to prevent workpieces from falling due to alarms or overtravels. Set the servomotor so that it will stop in the zero clamp state when overtravel occurs.
Failure to observe this caution may cause workpieces to fall due to overtravel.
- When not using turning-less function, set to the correct moment of inertia ratio (Pn103).
Setting to an incorrect moment of inertia ratio may cause machine vibration.
- Do not touch the SERVOPACK heatsinks, regenerative resistor, or servomotor while power is ON or soon after the power is turned OFF.
Failure to observe this caution may result in burns due to high temperatures.
- Do not make any extreme adjustments or setting changes of parameters.
Failure to observe this caution may result in injury or damage to the product due to unstable operation.
- When an alarm occurs, remove the cause, reset the alarm after confirming safety, and then resume operation.
Failure to observe this caution may result in damage to the product, fire, or injury.
- Do not use the brake of the servomotor for braking.
Failure to observe this caution may result in malfunction.
- An alarm or warning may be generated if communications are executed with the host controller during operation using SigmaWin+ or the digital operator.
If an alarm or warning is generated, the process currently being executed may be aborted and the system may stop.

■ Maintenance and Inspection

CAUTION

- Do not disassemble the SERVOPACK.
Failure to observe this caution may result in electric shock or injury.
- Do not change wiring while the power is ON.
Failure to observe this caution may result in electric shock or injury.
- When replacing the SERVOPACK, resume operation only after copying the previous SERVOPACK parameters to the new SERVOPACK.
Failure to observe this caution may result in damage to the product.

■ Disposal



CAUTION

- When disposing of the products, treat them as ordinary industrial waste.

■ General Precautions

**Observe the following general precautions
to ensure safe application.**

- The products shown in illustrations in this manual are sometimes shown without covers or protective guards. Always replace the cover or protective guard as specified first, and then operate the products in accordance with the manual.
- The drawings presented in this manual are typical examples and may not match the product you received.
- If the manual must be ordered due to loss or damage, inform your nearest Yaskawa representative or one of the offices listed on the back of this manual.

Warranty

(1) Details of Warranty

■ Warranty Period

The warranty period for a product that was purchased (hereinafter called “delivered product”) is one year from the time of delivery to the location specified by the customer or 18 months from the time of shipment from the Yaskawa factory, whichever is sooner.

■ Warranty Scope

Yaskawa shall replace or repair a defective product free of charge if a defect attributable to Yaskawa occurs during the warranty period above. This warranty does not cover defects caused by the delivered product reaching the end of its service life and replacement of parts that require replacement or that have a limited service life.

This warranty does not cover failures that result from any of the following causes.

1. Improper handling, abuse, or use in unsuitable conditions or in environments not described in product catalogs or manuals, or in any separately agreed-upon specifications
2. Causes not attributable to the delivered product itself
3. Modifications or repairs not performed by Yaskawa
4. Abuse of the delivered product in a manner in which it was not originally intended
5. Causes that were not foreseeable with the scientific and technological understanding at the time of shipment from Yaskawa
6. Events for which Yaskawa is not responsible, such as natural or human-made disasters

(2) Limitations of Liability

1. Yaskawa shall in no event be responsible for any damage or loss of opportunity to the customer that arises due to failure of the delivered product.
2. Yaskawa shall not be responsible for any programs (including parameter settings) or the results of program execution of the programs provided by the user or by a third party for use with programmable Yaskawa products.
3. The information described in product catalogs or manuals is provided for the purpose of the customer purchasing the appropriate product for the intended application. The use thereof does not guarantee that there are no infringements of intellectual property rights or other proprietary rights of Yaskawa or third parties, nor does it construe a license.
4. Yaskawa shall not be responsible for any damage arising from infringements of intellectual property rights or other proprietary rights of third parties as a result of using the information described in catalogs or manuals.

(3) Suitability for Use

1. It is the customer's responsibility to confirm conformity with any standards, codes, or regulations that apply if the Yaskawa product is used in combination with any other products.
2. The customer must confirm that the Yaskawa product is suitable for the systems, machines, and equipment used by the customer.
3. Consult with Yaskawa to determine whether use in the following applications is acceptable. If use in the application is acceptable, use the product with extra allowance in ratings and specifications, and provide safety measures to minimize hazards in the event of failure.
 - Outdoor use, use involving potential chemical contamination or electrical interference, or use in conditions or environments not described in product catalogs or manuals
 - Nuclear energy control systems, combustion systems, railroad systems, aviation systems, vehicle systems, medical equipment, amusement machines, and installations subject to separate industry or government regulations
 - Systems, machines, and equipment that may present a risk to life or property
 - Systems that require a high degree of reliability, such as systems that supply gas, water, or electricity, or systems that operate continuously 24 hours a day
 - Other systems that require a similar high degree of safety
4. Never use the product for an application involving serious risk to life or property without first ensuring that the system is designed to secure the required level of safety with risk warnings and redundancy, and that the Yaskawa product is properly rated and installed.
5. The circuit examples and other application examples described in product catalogs and manuals are for reference. Check the functionality and safety of the actual devices and equipment to be used before using the product.
6. Read and understand all use prohibitions and precautions, and operate the Yaskawa product correctly to prevent accidental harm to third parties.

(4) Specifications Change

The names, specifications, appearance, and accessories of products in product catalogs and manuals may be changed at any time based on improvements and other reasons. The next editions of the revised catalogs or manuals will be published with updated code numbers. Consult with your Yaskawa representative to confirm the actual specifications before purchasing a product.

Applicable Standards

■ North American Safety Standards (UL/CSA)

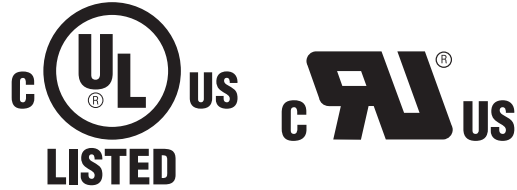

	Model	UL* Standards (UL File No.)
SERVOPACK	• SGD V	UL508C (E147823)
Servomotor	• SGMJV • SGM AV • SGMPS • SGMGV • SGM SV	UL1004 (E165827)

* Underwriters Laboratories Inc.

■ European Standards



	Model	Low Voltage Directive	EMC Directive		Safety Standards
			EMI	EMS	
SERVOPACK	• SGD V	EN50178 EN61800-5-1	EN55011 group 1 class A, EN61800-3	EN61800-3 EN61000-6-2	EN954-1 IEC61508-1 to 4
Servomotor	• SGMJV • SGM AV • SGMPS • SGMGV • SGM SV	IEC60034-1 IEC60034-5 IEC60034-8 IEC60034-9	EN55011 group 1 class A, EN61800-3	EN61800-3 EN61000-6-2	—

Note: Because SERVOPACKs and servomotors are built into machines, certification is required after installation in the final product.

Contents

About this Manual	iii
Safety Precautions	vi
Warranty	xi
Applicable Standards	xiii

Chapter 1 Outline 1-1

1.1 Σ -V Series SERVOPACKs	1-2
1.2 SERVOPACKs	1-2
1.3 Part Names	1-2
1.4 SERVOPACK Ratings and Specifications	1-3
1.4.1 Ratings	1-3
1.4.2 Basic Specifications	1-4
1.5 SERVOPACK Internal Block Diagrams	1-6
1.5.1 Single-phase 100-V, SGD V-R70FE1A, -R90FE1A, -2R1FE1A Models	1-6
1.5.2 Single-phase 100-V, SGD V-2R8FE1A Model	1-6
1.5.3 Single-phase 200-V, SGD V-120AE1A008000 Model	1-7
1.5.4 Three-phase 200-V, SGD V-R70AE1A, -R90AE1A, -1R6AE1A Models	1-7
1.5.5 Three-phase 200-V, SGD V-2R8AE1A Model	1-8
1.5.6 Three-phase 200-V, SGD V-3R8AE1A, -5R5AE1A, -7R6AE1A Models	1-8
1.5.7 Three-phase 200-V, SGD V-120AE1A Model	1-9
1.5.8 Three-phase 200-V, SGD V-180AE1A, -200AE1A Models	1-9
1.5.9 Three-phase 200-V, SGD V-330AE1A Model	1-10
1.5.10 Three-phase 200-V, SGD V-470AE1A, -550AE1A Models	1-10
1.5.11 Three-phase 200-V, SGD V-590AE1A, -780AE1A Models	1-11
1.5.12 Three-phase 400-V, SGD V-1R9DE1A, -3R5DE1A, -5R4DE1A Models	1-11
1.5.13 Three-phase 400-V, SGD V-8R4DE1A, -120DE1A Models	1-12
1.5.14 Three-phase 400-V, SGD V-170DE1A Model	1-12
1.5.15 Three-phase 400-V, SGD V-210DE1A, -260DE1A Models	1-13
1.5.16 Three-phase 400-V, SGD V-280DE1A, -370DE1A Models	1-13
1.6 Examples of Servo System Configurations	1-14
1.6.1 Connecting to SGD V-□□□FE1A SERVOPACK	1-14
1.6.2 Connecting to SGD V-□□□AE1A SERVOPACK	1-15
1.6.3 Connecting to SGD V-□□□DE1A SERVOPACK	1-17
1.7 SERVOPACK Model Designation	1-18
1.8 Inspection and Maintenance	1-19

Chapter 2 Panel Display and Operation of Digital Operator 2-1

2.1 Panel Display	2-2
2.1.1 Status Display	2-2
2.1.2 Alarm and Warning Display	2-2
2.1.3 Hard Wire Base Block Display	2-2
2.1.4 Displays during Overtravel	2-2
2.2 Utility Function Mode (Fn□□□)	2-3
2.3 Parameter (Pn□□□) Operation	2-4
2.3.1 Parameter Classifications	2-4
2.3.2 Parameter Notation	2-4
2.3.3 Parameter Setting Methods	2-5
2.4 Monitor Mode (Un□□□)	2-7

Chapter 3 Wiring and Connection	3-1
3.1 Main Circuit Wiring	3-2
3.1.1 Main Circuit Terminals	3-2
3.1.2 Using a Standard Power Supply Input (Single-phase 100-V, Three-phase 200-V, or Three-phase 400-V)	3-3
3.1.3 Using the SERVOPACK with Single-phase, 200-V Power Input	3-12
3.1.4 Using the SERVOPACK with a DC Power Input	3-15
3.1.5 Using More Than One SERVOPACK	3-17
3.1.6 General Precautions for Wiring	3-18
3.2 I/O Signal Connections	3-19
3.2.1 I/O Signal (CN1) Names and Functions	3-19
3.2.2 Safety Function Signal (CN8) Names and Functions	3-20
3.2.3 Example of I/O Signal Connections	3-21
3.3 I/O Signal Allocations	3-22
3.3.1 Input Signal Allocations	3-22
3.3.2 Output Signal Allocation	3-24
3.4 Connection to Host Controller	3-25
3.4.1 Sequence Input Circuits	3-25
3.4.2 Sequence Output Circuits	3-27
3.5 Wiring Communications Using Command Option Modules	3-29
3.6 Encoder Connections	3-30
3.6.1 Encoder Signal (CN2) Names and Functions	3-30
3.6.2 Examples of Encoder Connection	3-30
3.7 Regenerative Resistors Connections	3-32
3.7.1 Connecting Regenerative Resistors	3-32
3.7.2 Setting Regenerative Resistor Capacity	3-34
3.8 Noise Control and Measures for Harmonic Suppression	3-35
3.8.1 Wiring for Noise Control	3-35
3.8.2 Precautions on Connecting Noise Filter	3-37
3.8.3 Connecting AC/DC Reactor for Harmonic Suppression	3-39

Chapter 4 Operation	4-1
4.1 Option Module Function Settings	4-2
4.1.1 Setting Switches S1 and S2 for Option Module Functions	4-2
4.2 Settings for Common Basic Functions	4-3
4.2.1 Inspection and Checking before Operation	4-3
4.2.2 Servomotor Rotation Direction	4-4
4.2.3 Overtravel	4-5
4.2.4 Electronic Gear	4-8
4.2.5 Encoder Output Pulses	4-11
4.2.6 Encoder Output Pulse Setting	4-12
4.2.7 Holding Brakes	4-13
4.2.8 Stopping Servomotor after Receiving Servo OFF Command or Alarm Occurrence	4-18
4.2.9 Instantaneous Power Interruption Settings	4-20
4.2.10 SEMI-F47 Function (Torque Limit Function for Low Power Supply Voltage for Main Circuit)	4-21
4.2.11 Setting Motor Overload Detection Level	4-24
4.3 Test Without Motor Function	4-26
4.3.1 Related Parameters	4-26
4.3.2 Limitations	4-27
4.3.3 Digital Operator Display during Testing without Motor	4-28
4.4 Limiting Torque	4-29
4.4.1 Internal Torque Limit	4-29
4.4.2 External Torque Limit	4-30
4.4.3 Checking Output Torque Limiting during Operation	4-31

4.5 Absolute Encoders	4-32
4.5.1 Connecting the Absolute Encoder	4-33
4.5.2 Absolute Data Request (Sensor ON Command)	4-35
4.5.3 Battery Replacement	4-36
4.5.4 Absolute Encoder Setup (Initialization)	4-38
4.5.5 Absolute Encoder Reception Sequence	4-39
4.5.6 Multiturn Limit Setting	4-42
4.5.7 Multi-turn Limit Disagreement (A.CC0)	4-43
4.6 Safety Function	4-44
4.6.1 Hard Wire Base Block (HWBB) Function	4-44
4.6.2 External Device Monitor (EDM1)	4-49
4.6.3 Application Example of Safety Functions	4-51
4.6.4 Confirming Safety Functions	4-52
4.6.5 Connecting a Safety Device	4-53
4.6.6 Precautions for Safety Functions	4-54

Chapter 5 Adjustments 5-1

5.1 Adjustments and Basic Adjustment Procedure	5-3
5.1.1 Adjustments	5-3
5.1.2 Basic Adjustment Procedure	5-4
5.1.3 Monitoring Analog Signals	5-5
5.1.4 Safety Precautions on Adjustment of Servo Gains	5-8
5.2 Tuning-less Function	5-10
5.2.1 Tuning-less Function	5-10
5.2.2 Tuning-less Levels Setting (Fn200) Procedure	5-13
5.3 Advanced Autotuning (Fn201)	5-15
5.3.1 Advanced Autotuning	5-15
5.3.2 Advanced Autotuning Procedure	5-17
5.3.3 Related Parameters	5-23
5.4 Advanced Autotuning by Reference (Fn202)	5-24
5.4.1 Advanced Autotuning by Reference	5-24
5.4.2 Advanced Autotuning by Reference Procedure	5-26
5.4.3 Related Parameters	5-30
5.5 One-parameter Tuning (Fn203)	5-31
5.5.1 One-parameter Tuning	5-31
5.5.2 One-parameter Tuning Procedure	5-32
5.5.3 One-parameter Tuning Example	5-38
5.5.4 Related Parameters	5-39
5.6 Anti-resonance Control Adjustment Function (Fn204)	5-40
5.6.1 Anti-resonance Control Adjustment Function	5-40
5.6.2 Anti-resonance Control Adjustment Function Operating Procedure	5-41
5.6.3 Related Parameters	5-45
5.7 Vibration Suppression Function (Fn205)	5-46
5.7.1 Vibration Suppression Function	5-46
5.7.2 Vibration Suppression Function Operating Procedure	5-47
5.7.3 Related Parameters	5-50
5.8 Additional Adjustment Function	5-51
5.8.1 Switching Gain Settings	5-51
5.8.2 Friction Compensation	5-56
5.8.3 Current Control Mode Selection	5-58
5.8.4 Current Gain Level Setting	5-58
5.8.5 Speed Detection Method Selection	5-58
5.9 Compatible Adjustment Function	5-59
5.9.1 Feedforward Reference	5-59
5.9.2 Using the Mode Switch (P/PI Switching)	5-59
5.9.3 Torque Reference Filter	5-64
5.9.4 Position Integral Time Constant	5-65

Chapter 6 Utility Functions (Fn□□□)	6-1
6.1 List of Utility Functions	6-2
6.2 Alarm History Display (Fn000)	6-3
6.3 JOG Operation (Fn002)	6-4
6.4 Origin Search (Fn003)	6-6
6.5 Program JOG Operation (Fn004)	6-8
6.6 Initializing Parameter Settings (Fn005)	6-13
6.7 Clearing Alarm History (Fn006)	6-14
6.8 Offset Adjustment of Analog Monitor Output (Fn00C)	6-15
6.9 Gain Adjustment of Analog Monitor Output (Fn00D)	6-17
6.10 Automatic Offset-Signal Adjustment of the Motor Current Detection (Fn00E)	6-19
6.11 Manual Offset-Signal Adjustment of the Motor Current Detection (Fn00F)	6-20
6.12 Write Prohibited Setting (Fn010)	6-21
6.13 Servomotor Model Display (Fn011)	6-23
6.14 Software Version Display (Fn012)	6-24
6.15 Resetting Configuration Error of Option Module (Fn014)	6-25
6.16 Vibration Detection Level Initialization (Fn01B)	6-26
6.17 Display of SERVOPACK and Servomotor ID (Fn01E)	6-28
6.18 Display of Servomotor ID in Feedback Option Module (Fn01F)	6-29
6.19 Origin Setting (Fn020)	6-30
6.20 Software Reset (Fn030)	6-31
6.21 EasyFFT (Fn206)	6-32
6.22 Online Vibration Monitor (Fn207)	6-36
Chapter 7 Monitor Modes (Un□□□)	7-1
7.1 List of Monitor Modes	7-2
7.2 Monitor Displays	7-3
Chapter 8 Fully-closed Loop Control	8-1
8.1 System Configuration and Connection Example for SERVOPACK with Fully-closed Loop Control	8-2
8.1.1 System Configuration	8-2
8.1.2 Internal Block Diagram of Fully-closed Loop Control	8-3
8.1.3 Serial Converter Unit	8-4
8.1.4 Example of Connections to External Encoders	8-6
8.1.5 Encoder Output Pulse Signals from SERVOPACK with an External Encoder by Renishaw plc	8-7
8.1.6 Precautions When Using an External Incremental Encoder by Magnescale	8-8
8.2 SERVOPACK Startup Procedure	8-12
8.3 Parameter Settings for Fully-closed Loop Control	8-14
8.3.1 Motor Rotation Direction	8-15
8.3.2 Sine Wave Pitch (Frequency) for an External Encoder	8-17
8.3.3 Setting Encoder Output Pulses (PAO, PBO, and PCO)	8-17
8.3.4 External Absolute Encoder Data Reception Sequence	8-18
8.3.5 Electronic Gear	8-21
8.3.6 Alarm Detection	8-22
8.3.7 Analog Monitor Signal	8-23
8.3.8 Speed Feedback Method during Fully-closed Loop Control	8-23

Chapter 9 Troubleshooting	9-1
9.1 Troubleshooting	9-2
9.1.1 List of Alarms	9-2
9.1.2 Troubleshooting of Alarms	9-6
9.2 Warning Displays	9-22
9.2.1 List of Warnings	9-22
9.2.2 Troubleshooting of Warnings	9-24
9.3 Troubleshooting Malfunction Based on Operation and Conditions of the Servomotor	9-28
 Chapter 10 Appendix	 10-1
10.1 List of Parameters	10-2
10.1.1 Utility Functions	10-2
10.1.2 Parameters	10-3
10.2 Monitor Modes	10-22
10.3 Parameter Recording Table	10-23
 Index	 Index-1
 Revision History	

Outline

1.1 Σ -V Series SERVOPACKs	1-2
1.2 SERVOPACKs	1-2
1.3 Part Names	1-2
1.4 SERVOPACK Ratings and Specifications	1-3
1.4.1 Ratings	1-3
1.4.2 Basic Specifications	1-4
1.5 SERVOPACK Internal Block Diagrams	1-6
1.5.1 Single-phase 100-V, SGD V-R70FE1A, -R90FE1A, -2R1FE1A Models	1-6
1.5.2 Single-phase 100-V, SGD V-2R8FE1A Model	1-6
1.5.3 Single-phase 200-V, SGD V-120AE1A008000 Model	1-7
1.5.4 Three-phase 200-V, SGD V-R70AE1A, -R90AE1A, -1R6AE1A Models	1-7
1.5.5 Three-phase 200-V, SGD V-2R8AE1A Model	1-8
1.5.6 Three-phase 200-V, SGD V-3R8AE1A, -5R5AE1A, -7R6AE1A Models	1-8
1.5.7 Three-phase 200-V, SGD V-120AE1A Model	1-9
1.5.8 Three-phase 200-V, SGD V-180AE1A, -200AE1A Models	1-9
1.5.9 Three-phase 200-V, SGD V-330AE1A Model	1-10
1.5.10 Three-phase 200-V, SGD V-470AE1A, -550AE1A Models	1-10
1.5.11 Three-phase 200-V, SGD V-590AE1A, -780AE1A Models	1-11
1.5.12 Three-phase 400-V, SGD V-1R9DE1A, -3R5DE1A, -5R4DE1A Models	1-11
1.5.13 Three-phase 400-V, SGD V-8R4DE1A, -120DE1A Models	1-12
1.5.14 Three-phase 400-V, SGD V-170DE1A Model	1-12
1.5.15 Three-phase 400-V, SGD V-210DE1A, -260DE1A Models	1-13
1.5.16 Three-phase 400-V, SGD V-280DE1A, -370DE1A Models	1-13
1.6 Examples of Servo System Configurations	1-14
1.6.1 Connecting to SGD V-□□□FE1A SERVOPACK	1-14
1.6.2 Connecting to SGD V-□□□AE1A SERVOPACK	1-15
1.6.3 Connecting to SGD V-□□□DE1A SERVOPACK	1-17
1.7 SERVOPACK Model Designation	1-18
1.8 Inspection and Maintenance	1-19

1.1 Σ-V Series SERVOPACKs

The Σ-V Series SERVOPACKs are designed for applications that require frequent high-speed, high-precision positioning. The SERVOPACK makes the most of machine performance in the shortest time possible, thus contributing to improving productivity.

1.2 SERVOPACKs

The command option attachable type SERVOPACK is used with command option modules. For reference methods, I/O signals, and other operations, refer to the manual for the command option module that is connected.

1.3 Part Names

This section gives the part names of the SGD-V SERVOPACK (command option attachable type).

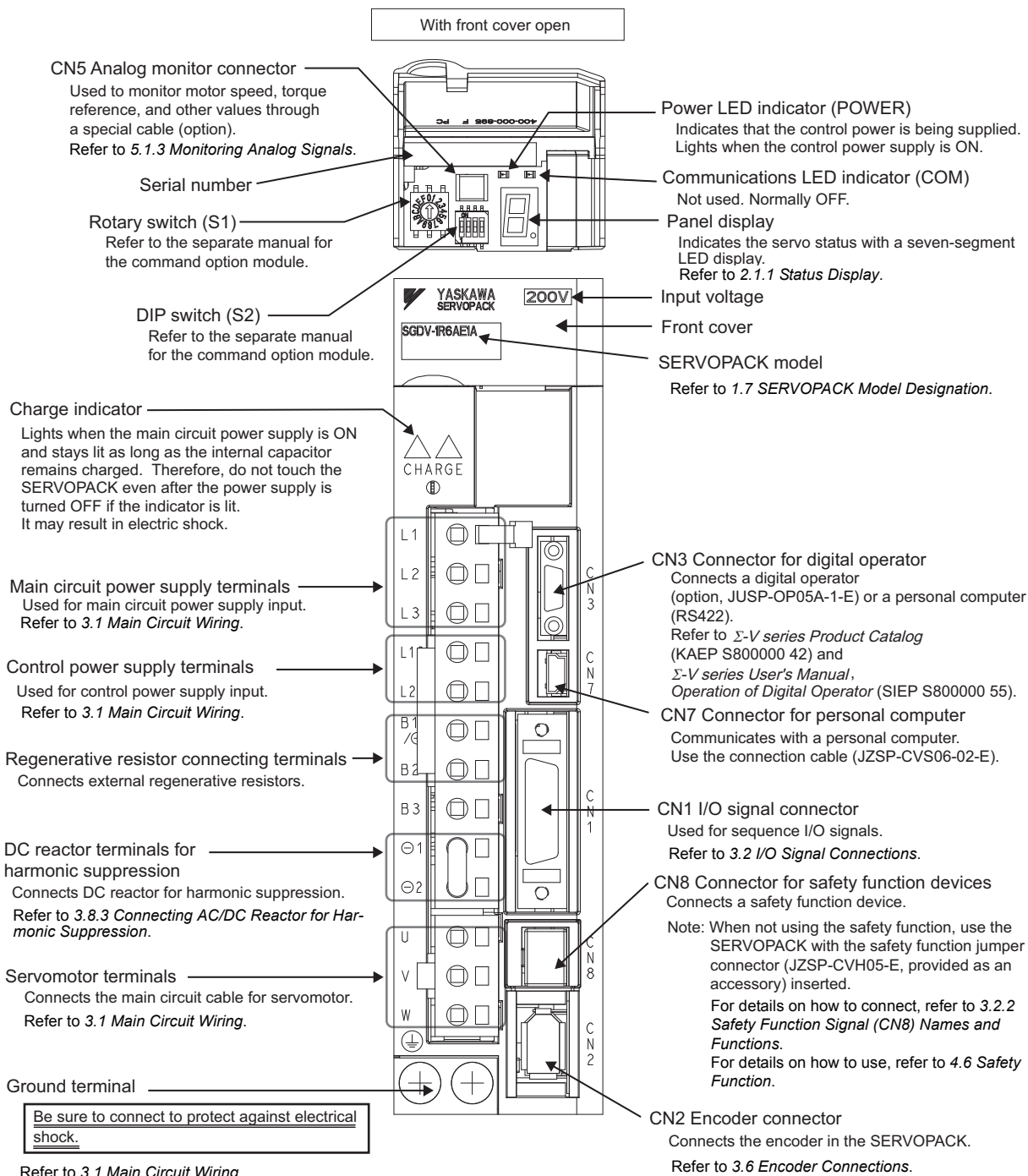

1.4 SERVOPACK Ratings and Specifications

This section describes the ratings and specifications of SERVOPACKs.

1.4.1 Ratings

Ratings of SERVOPACKs are as shown below.

(1) SGDV Single-phase 100-V Ratings

SGDV (Single-phase, 100 V)	R70	R90	2R1	2R8
Continuous Output Current [Arms]	0.66	0.91	2.1	2.8
Max. Output Current [Arms]	2.1	2.9	6.5	9.3
Regenerative Resistor	None/External			
Main Circuit Power Supply	Single-phase, 100 to 115 VAC $\begin{smallmatrix} +10\% \\ -15\% \end{smallmatrix}$, 50/60 Hz			
Control Power	Single-phase, 100 to 115 VAC $\begin{smallmatrix} +10\% \\ -15\% \end{smallmatrix}$, 50/60 Hz			
Overvoltage Category	III			

(2) SGDV Single-phase 200-V Ratings

SGDV (Single-phase, 200 V)	120*
Continuous Output Current [Arms]	11.6
Max. Output Current [Arms]	28
Regenerative Resistor	Built-in/External
Main Circuit Power Supply	Single-phase, 220 to 230 VAC $\begin{smallmatrix} +10\% \\ -15\% \end{smallmatrix}$, 50/60 Hz
Control Power	Single-phase, 220 to 230 VAC $\begin{smallmatrix} +10\% \\ -15\% \end{smallmatrix}$, 50/60 Hz
Overvoltage Category	III

* The official model number is SGDV-120AE1A008000.

(3) SGDV Three-phase 200-V Ratings

SGDV (Three-phase, 200 V)	R70	R90	1R6	2R8	3R8	5R5	7R6	120	180	200	330	470	550	590	780
Continuous Output Current [Arms]	0.66	0.91	1.6	2.8	3.8	5.5	7.6	11.6	18.5	19.6	32.9	46.9	54.7	58.6	78.0
Max. Output Current [Arms]	2.1	2.9	5.8	9.3	11.0	16.9	17	28	42	56	84	110	130	140	170
Regenerative Resistor	None/External				Built-in/External						External				
Main Circuit Power Supply	Three-phase, 200 to 230 VAC $\begin{smallmatrix} +10\% \\ -15\% \end{smallmatrix}$, 50/60 Hz														
Control Power	Single-phase, 200 to 230 VAC $\begin{smallmatrix} +10\% \\ -15\% \end{smallmatrix}$, 50/60 Hz														
Overvoltage Category	III														

(4) SGDV Three-phase 400-V Ratings

SGDV (Three-phase, 400 V)	1R9	3R5	5R4	8R4	120	170	210	260	280	370
Continuous Output Current [Arms]	1.9	3.5	5.4	8.4	11.9	16.5	20.8	25.7	28.1	37.2
Max. Output Current [Arms]	5.5	8.5	14	20	28	42	55	65	70	85
Regenerative Resistor	Built-in/External						External			
Main Circuit Power Supply	Three-phase, 380 to 480 VAC $\begin{smallmatrix} +10\% \\ -15\% \end{smallmatrix}$, 50/60 Hz									
Control Power	24 VDC $\pm 15\%$									
Overvoltage Category	III									

1.4.2 Basic Specifications

Basic specifications of SERVOPACKs are shown below.

Control Method		IGBT-PWM (sine-wave driven)		
Feedback		Serial encoder: 13-bit (incremental), 17-bit, 20-bit (incremental/absolute)		
Operating Conditions	Surrounding Air/Storage Temperature	0 to +55°C/ -20 to +85°C		
	Ambient/Storage Humidity	90% RH or less (with no condensation)		
	Vibration/Shock Resistance	4.9 m/s ² / 19.6 m/s ²		
	Protection Class/ Pollution Degree	Protection class: IP10, Pollution degree: 2 An environment that satisfies the following conditions. <ul style="list-style-type: none"> • Free of corrosive or explosive gases • Free of exposure to water, oil or chemicals • Free of dust, salts or iron dust 		
	Altitude	1000 m or less		
	Others	Free of static electricity, strong electromagnetic fields, magnetic fields or exposure to radioactivity		
Applicable Standards		UL508C EN50178, EN55011 group 1 class A, EN61000-6-2, EN61800-3, EN61800-5-1, EN954-1, IEC61508-1 to 4		
Configuration		Base-mounted *1		
Performance	Speed Control Range		1:5000	
	Speed Regulation*2	Load Fluctuation	0 to 100% load: ±0.01% max. (at rated speed)	
		Voltage Fluctuation	Rated voltage ±10%: 0% (at rated speed)	
		Temperature Fluctuation	25 ± 25 °C: ±0.1% max. (at rated speed)	
	Torque Control Tolerance (Repeatability)		±1%	
I/O Signals	Encoder Output Pulses		Phase-A, -B, -C: line driver Encoder output pulse: any setting ratio	
	Sequence Input	Input Signals which can be allocated	Number of Channels	7 channels
			Functions	The signal allocation and positive/negative logic can be modified. Forward run prohibited (P-OT), reverse run prohibited (N-OT), forward external torque limit (/P-CL), reverse external torque limit (/N-CL), general-purpose input signal (/SI0 to /SI6)*3
	Sequence Output	Output Signals which can be allocated	Fixed Output	Servo alarm (ALM)
			Number of Channels	3 channels
	Functions	The signal allocation and positive/negative logic can be modified. Positioning completion (/COIN), speed coincidence detection (/V-CMP), servomotor rotation detection (/TGON), servo ready (/S-RDY), torque limit detection (/CLT), speed limit detection (/VLT), brake (/BK), warning (/WARN), near (/NEAR)		

(cont'd)

Communications Function	RS422A Communications (CN3)	Interface	Digital operator (JUSP-OP05A-1-E), personal computer (can be connected with SigmaWin+), etc.
		1:N Communications	N = Up to 15 stations possible at RS422A
		Axis Address Setting	Set by parameter
	USB Communications (CN7)	Interface	Personal computer (can be connected with SigmaWin+.)
		Communications Standard	Complies with standard USB1.1. (12 Mbps)
LED Display		Panel display (seven-segment, 1 digit), CHARGE and POWER indicators	
Analog Monitor (CN5)		Number of points: 2 Output voltage: ± 10V DC (linearity effective range ± 8V) Resolution: 16 bit Accuracy: ± 20 mV (Typ) Max. output current: ± 10 mA Settling time (± 1%): 1.2 ms (Typ)	
Dynamic Brake (DB)		Activated when a servo alarm, overtravel, or hard wire base block occurs or when the power supply for the main circuit or servomotor is turned OFF.	
Regenerative Processing		Built-in or external regenerative resistor (option)	
Overtravel Prevention (OT)		Dynamic brake stop at P-OT or N-OT, deceleration to a stop, or free run to a stop	
Protection Function		Overcurrent, overvoltage, insufficient voltage, overload, regeneration error, and so on.	
Utility Function		Gain adjustment, alarm history, JOG operation, origin search, and so on.	
Safety Function	Input	/HWBB1, /HWBB2: Baseblock signal for power module	
	Output	EDM1: Monitoring status of internal safety circuit (fixed output)	
Option Modules		Fully-closed option module and command option module	

*1. Rack mounting and duct-ventilated type available as an option.

*2. Speed regulation by load fluctuation is defined as follows:

$$\text{Speed regulation} = \frac{\text{No-load motor speed} - \text{Total load motor speed}}{\text{Rated motor speed}} \times 100\%$$

*3. For information on functions, refer to the manual of the connected command option module.

1.5 SERVOPACK Internal Block Diagrams

1.5.1 Single-phase 100-V, SGDVR70FE1A, -R90FE1A, -2R1FE1A Models

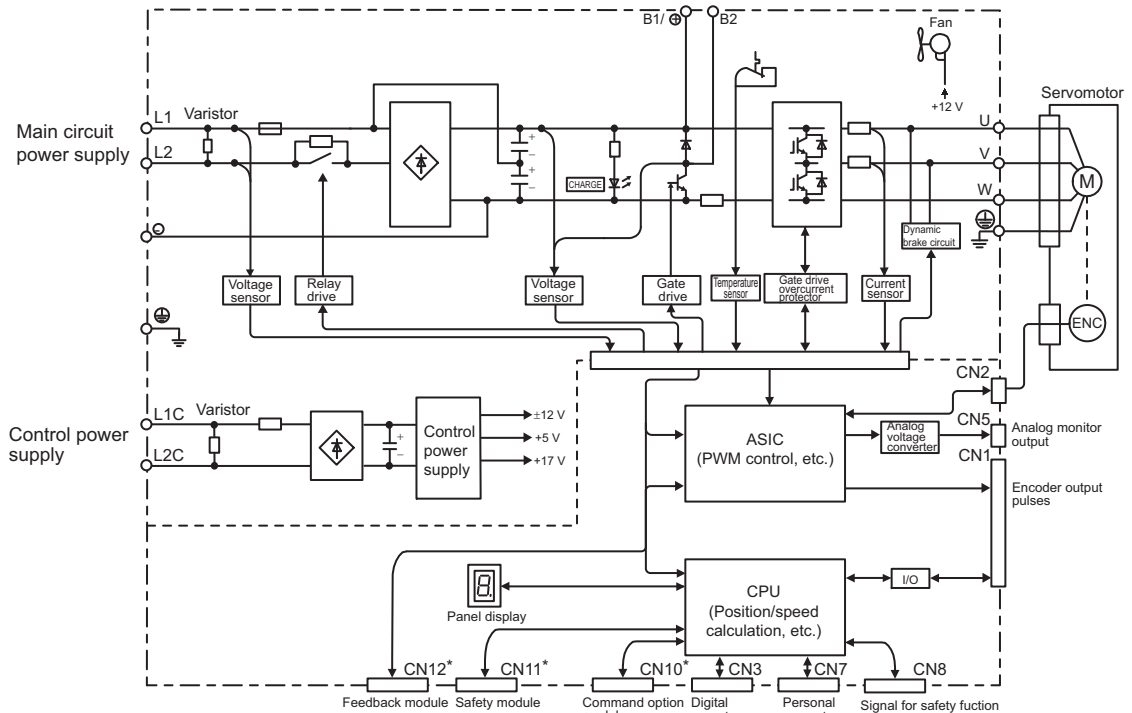

* This external input signal is used by the option module.
For details, refer to the manual of the connected option module.

1.5.2 Single-phase 100-V, SGDVR2R8FE1A Model

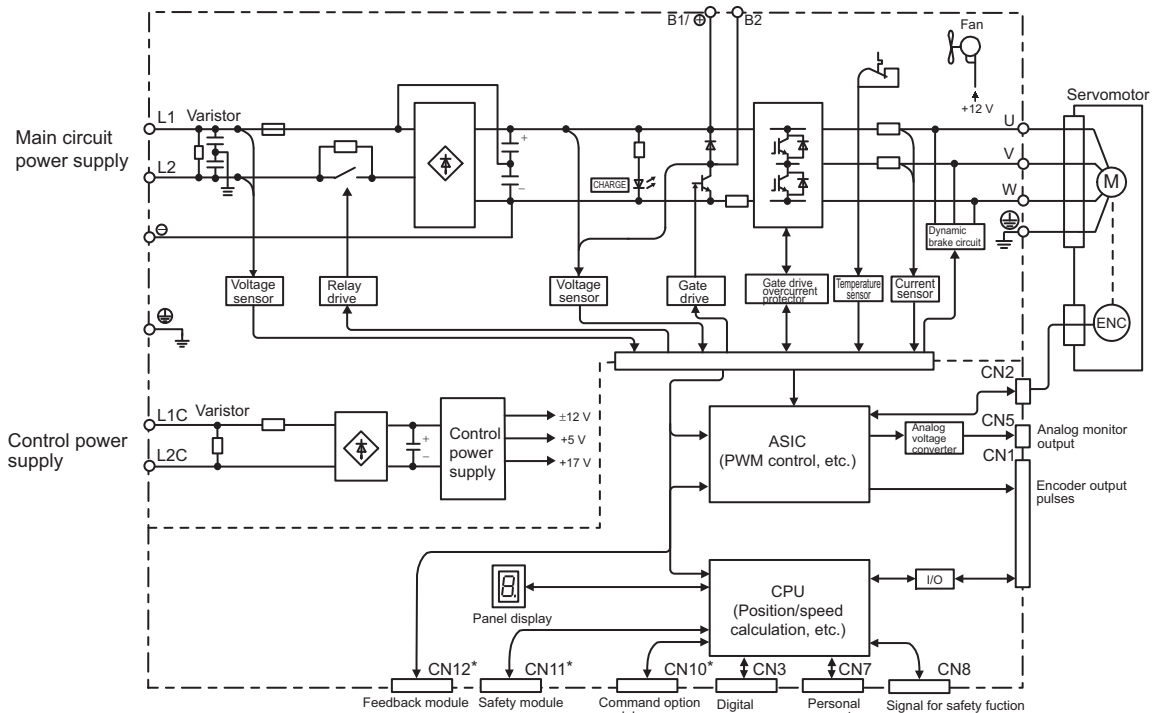

* This external input signal is used by the option module.
For details, refer to the manual of the connected option module.

1.5.3 Single-phase 200-V, SGDV-120AE1A008000 Model

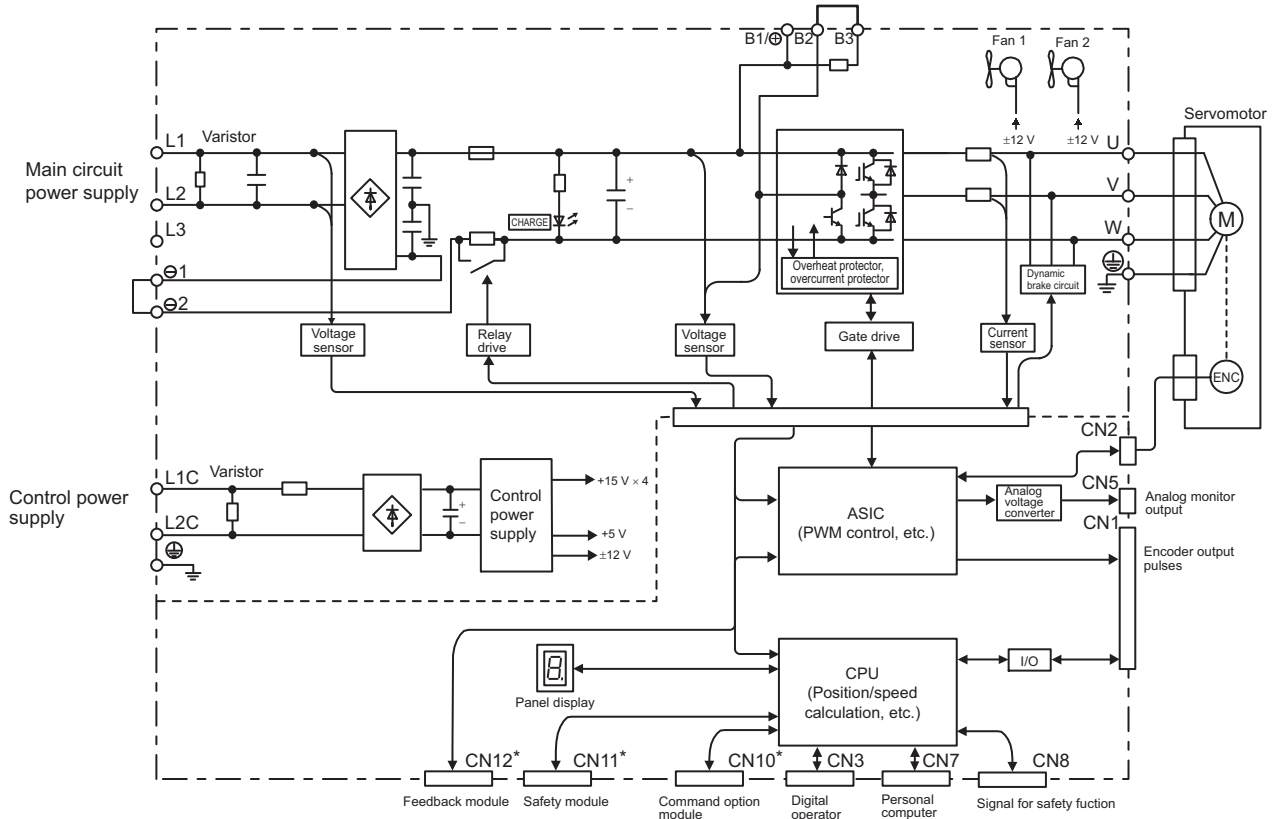

* This external input signal is used by the option module.
For details, refer to the manual of the connected option module.

1.5.4 Three-phase 200-V, SGDV-R70AE1A, -R90AE1A, -1R6AE1A Models

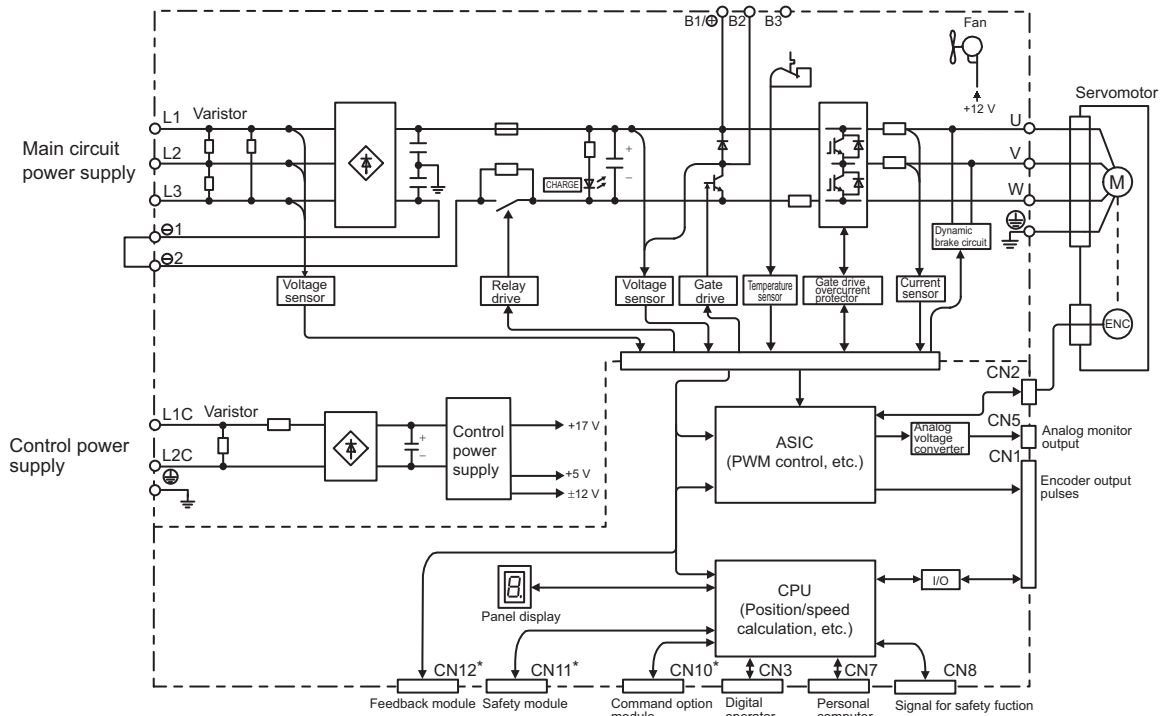

* This external input signal is used by the option module.
For details, refer to the manual of the connected option module.

1.5.5 Three-phase 200-V, SGDV-2R8AE1A Model

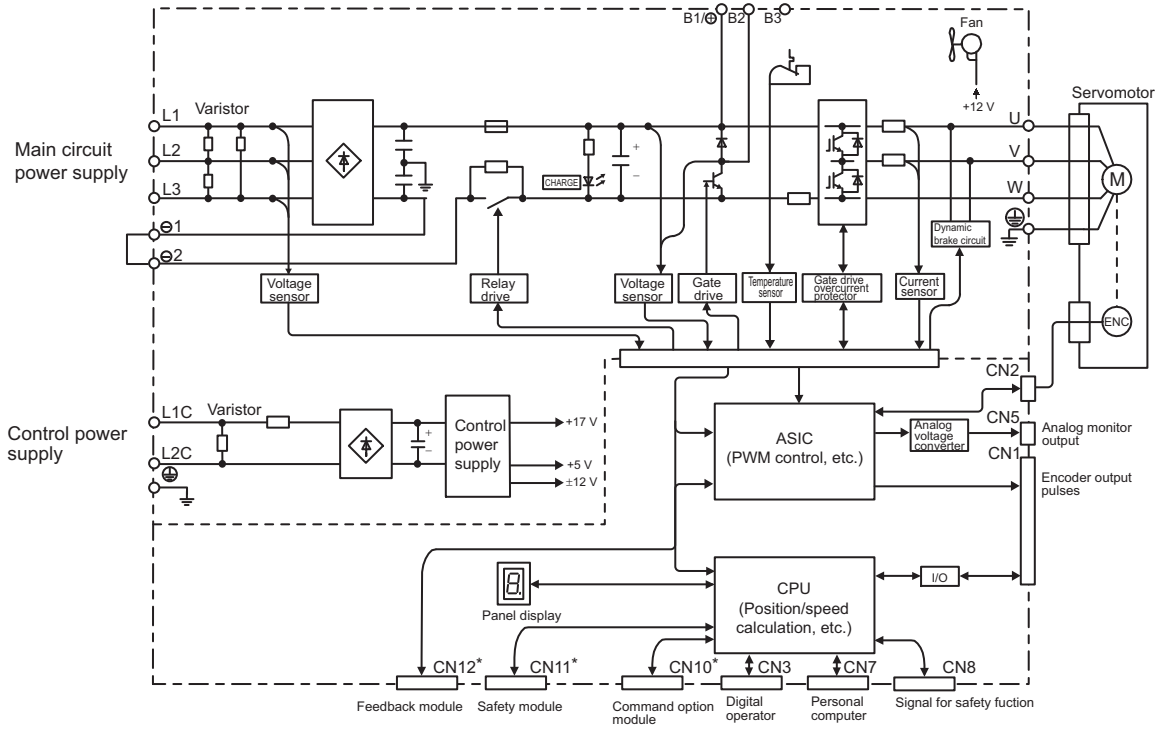

* This external input signal is used by the option module.
For details, refer to the manual of the connected option module.

1.5.6 Three-phase 200-V, SGDV-3R8AE1A, -5R5AE1A, -7R6AE1A Models

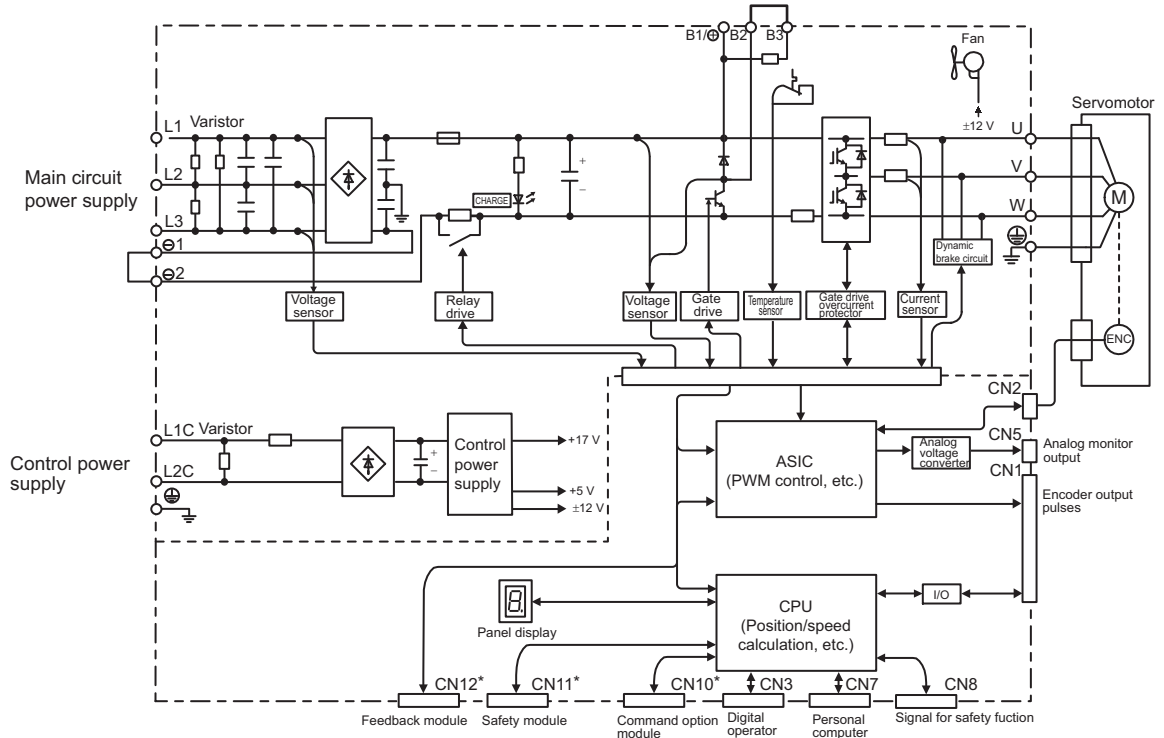

* This external input signal is used by the option module.
For details, refer to the manual of the connected option module.

1.5.7 Three-phase 200-V, SGDV-120AE1A Model

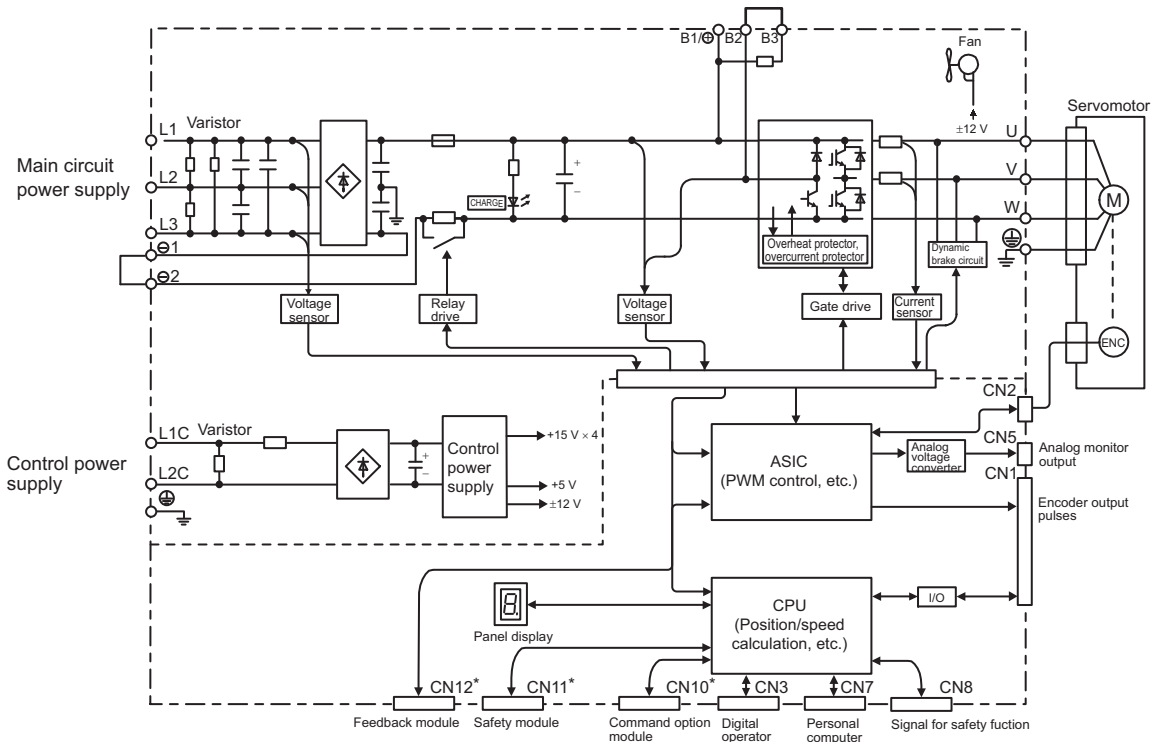

* This external input signal is used by the option module.
For details, refer to the manual of the connected option module.

1.5.8 Three-phase 200-V, SGDV-180AE1A, -200AE1A Models

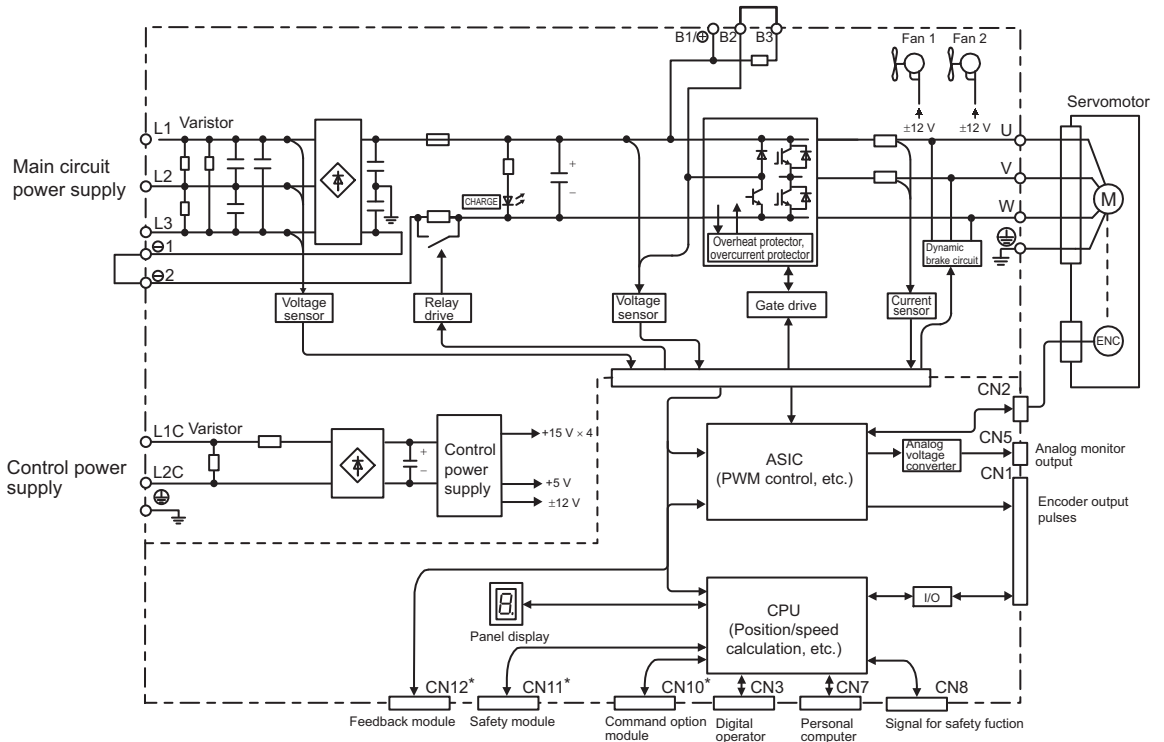

* This external input signal is used by the option module.
For details, refer to the manual of the connected option module.

1.5.9 Three-phase 200-V, SGD V-330AE1A Model

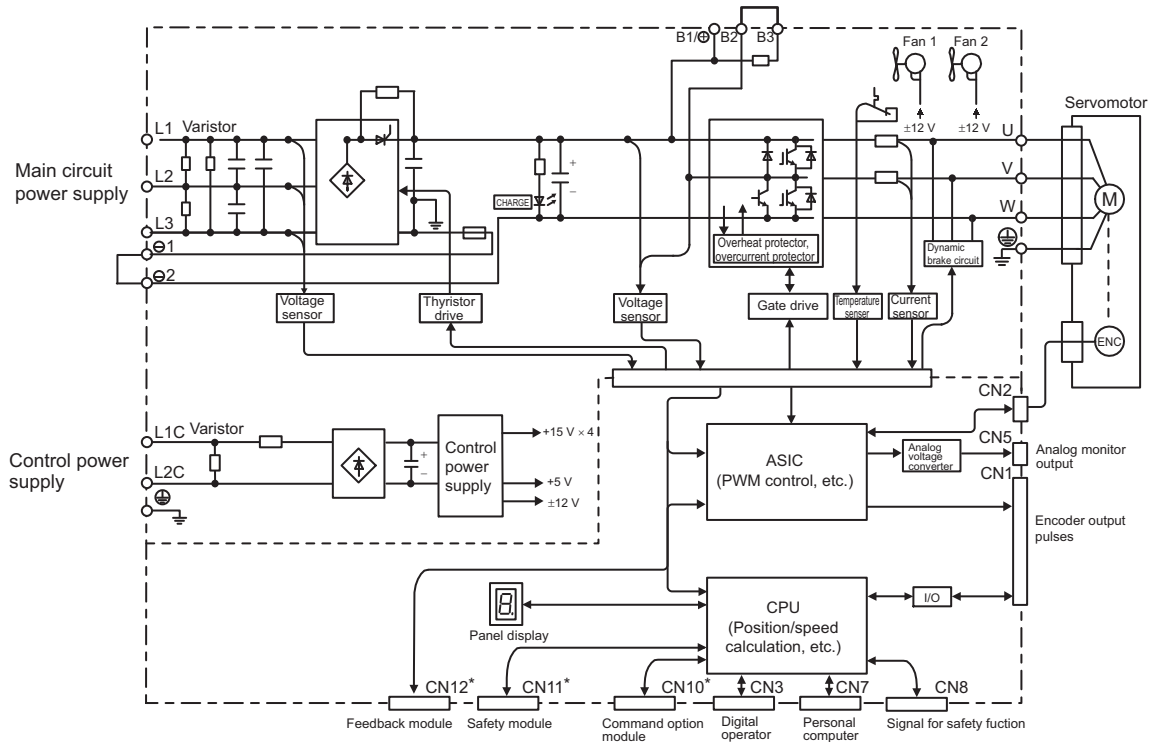

* This external input signal is used by the option module.
For details, refer to the manual of the connected option module.

1.5.10 Three-phase 200-V, SGD V-470AE1A, -550AE1A Models

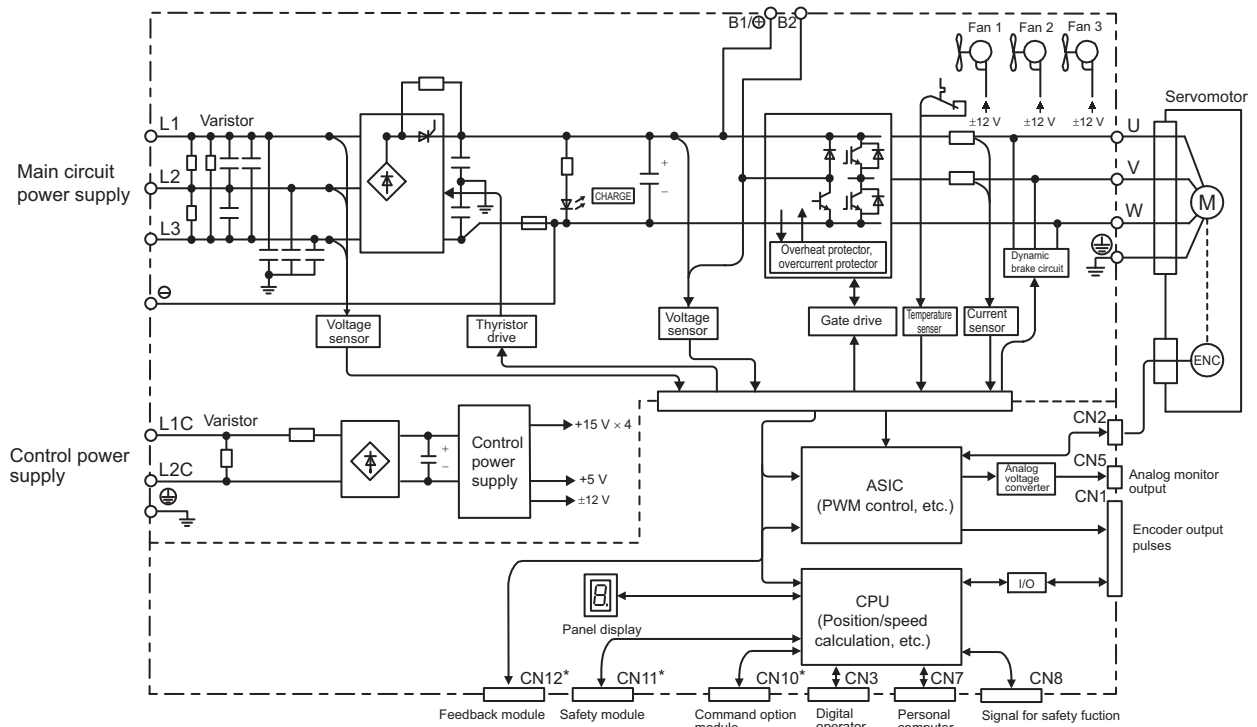

* This external input signal is used by the option module.
For details, refer to the manual of the connected option module.

1.5.11 Three-phase 200-V, SGD5-590AE1A, -780AE1A Models

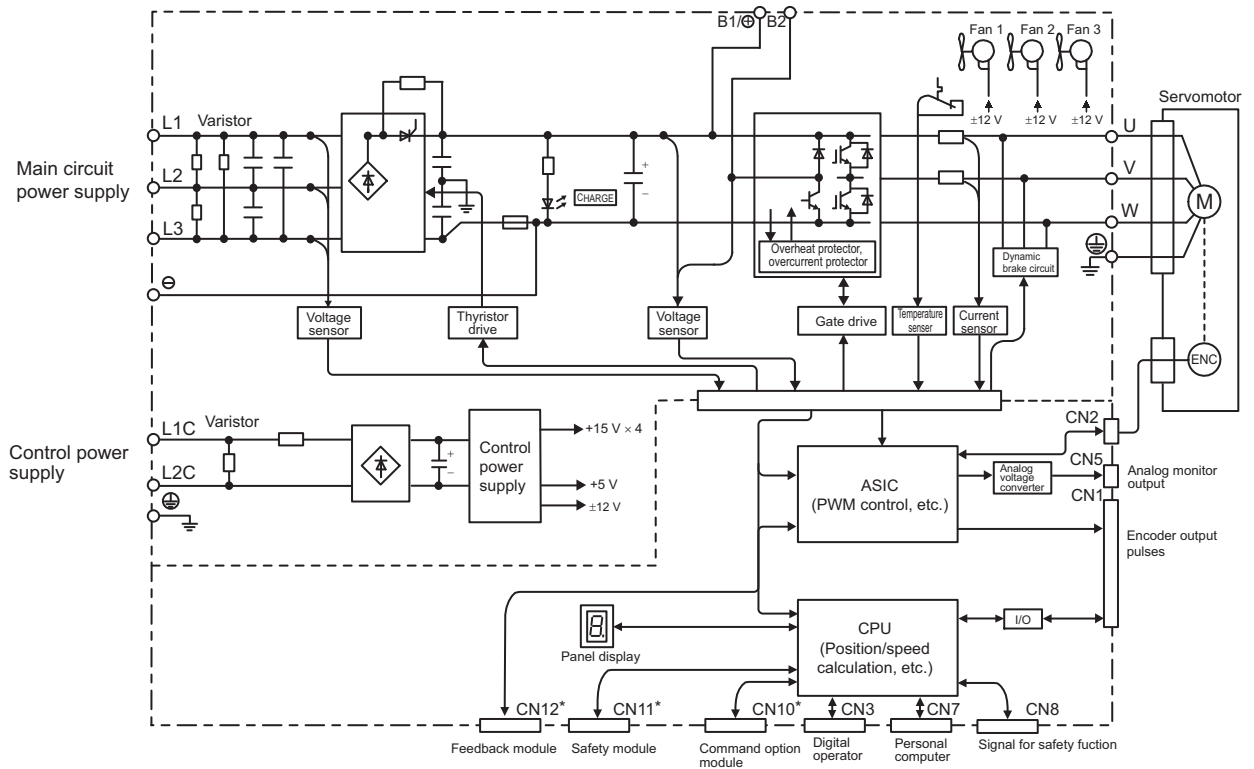

* This external input signal is used by the option module.
For details, refer to the manual of the connected option module.

1.5.12 Three-phase 400-V, SGD5-1R9DE1A, -3R5DE1A, -5R4DE1A Models

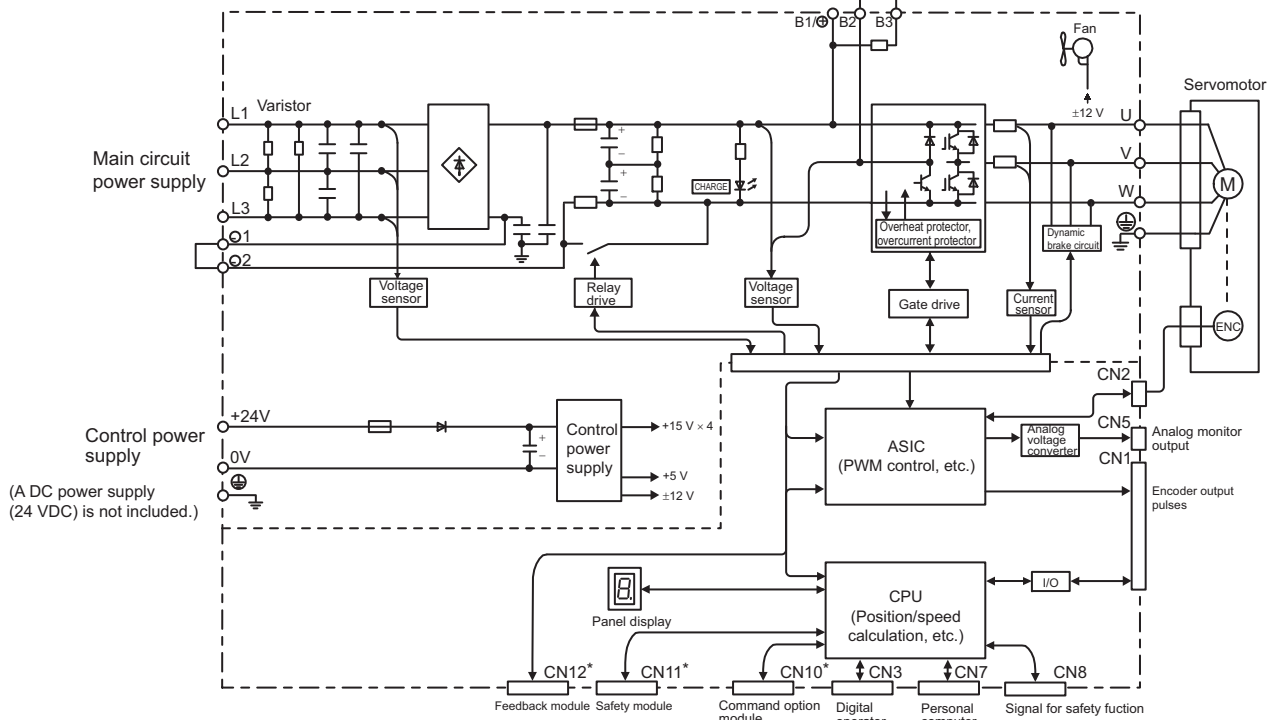

* This external input signal is used by the option module.
For details, refer to the manual of the connected option module.

1.5.13 Three-phase 400-V, SGDV-8R4DE1A, -120DE1A Models

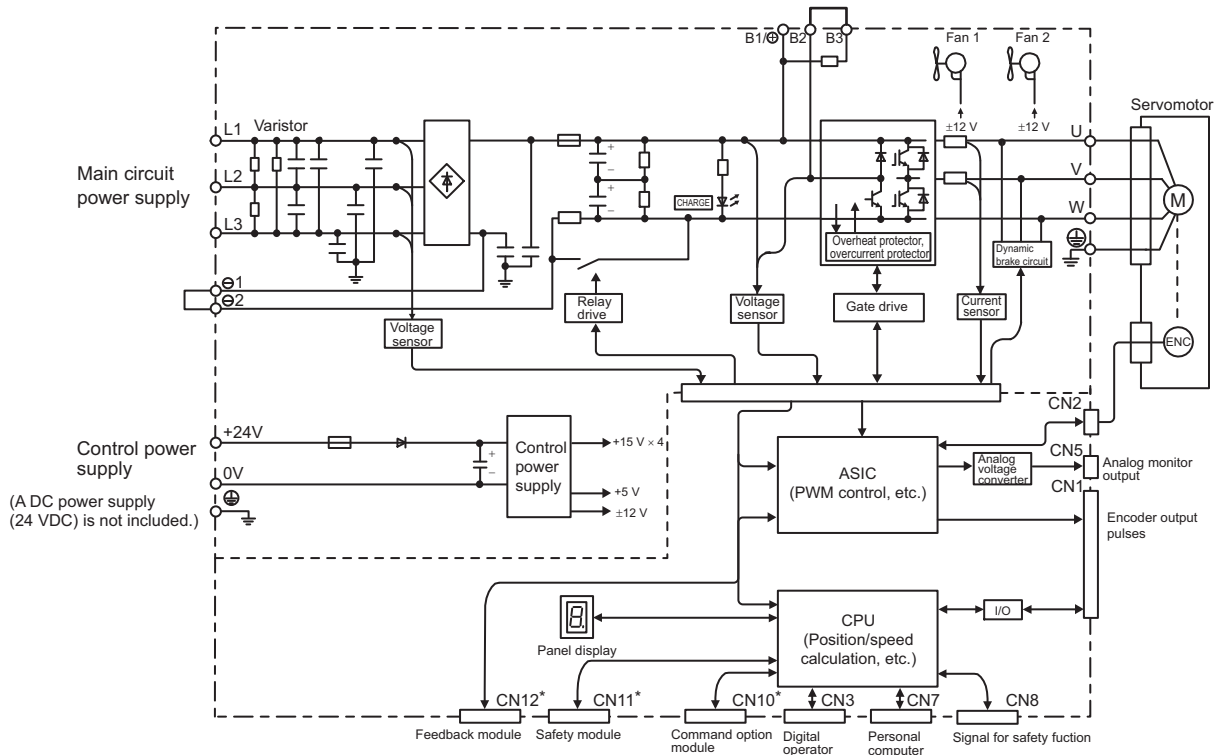

* This external input signal is used by the option module.
For details, refer to the manual of the connected option module.

1.5.14 Three-phase 400-V, SGDV-170DE1A Model

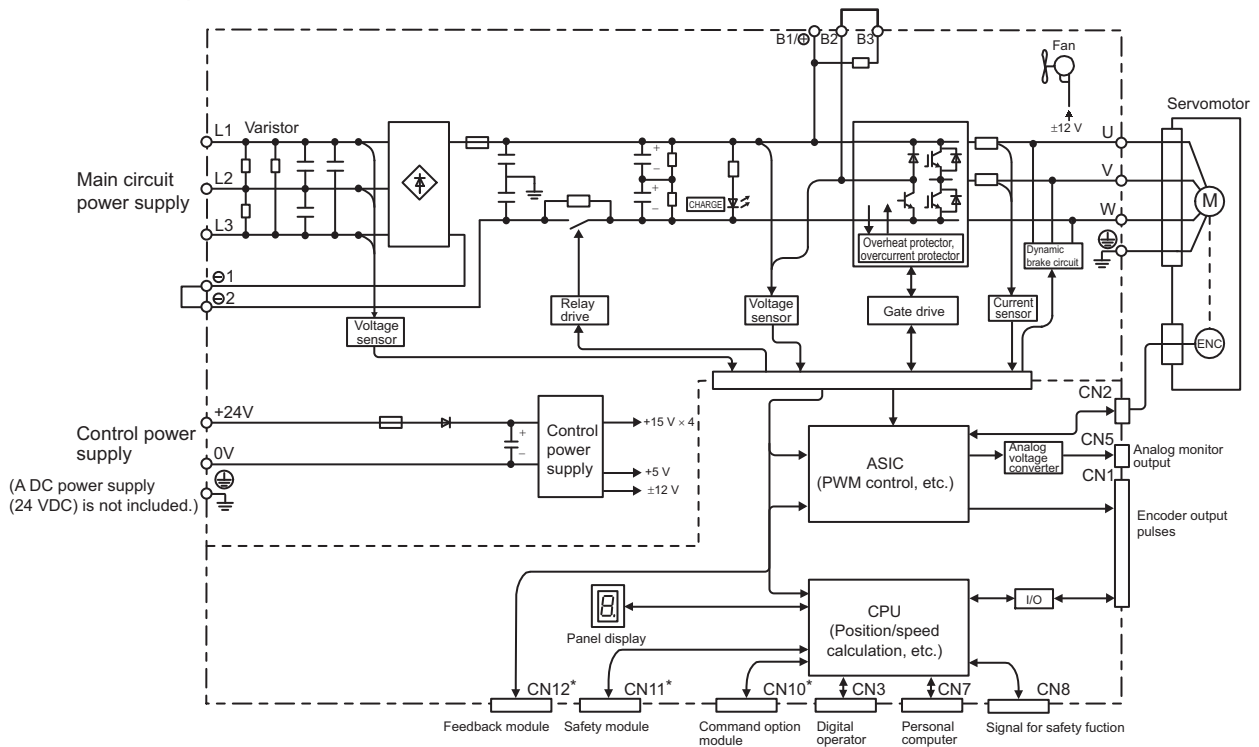

* This external input signal is used by the option module.
For details, refer to the manual of the connected option module.

1.5.15 Three-phase 400-V, SGDV-210DE1A, -260DE1A Models

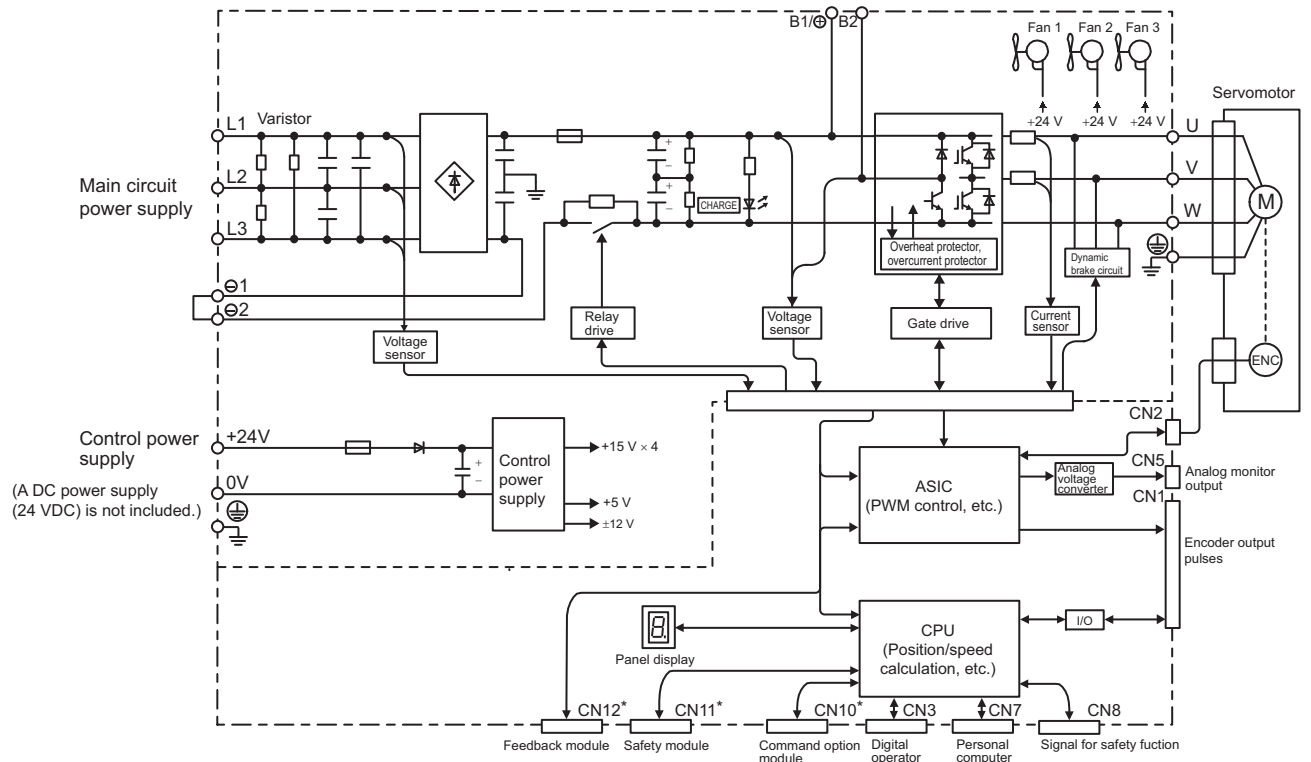

* This external input signal is used by the option module.
For details, refer to the manual of the connected option module.

1.5.16 Three-phase 400-V, SGDV-280DE1A, -370DE1A Models

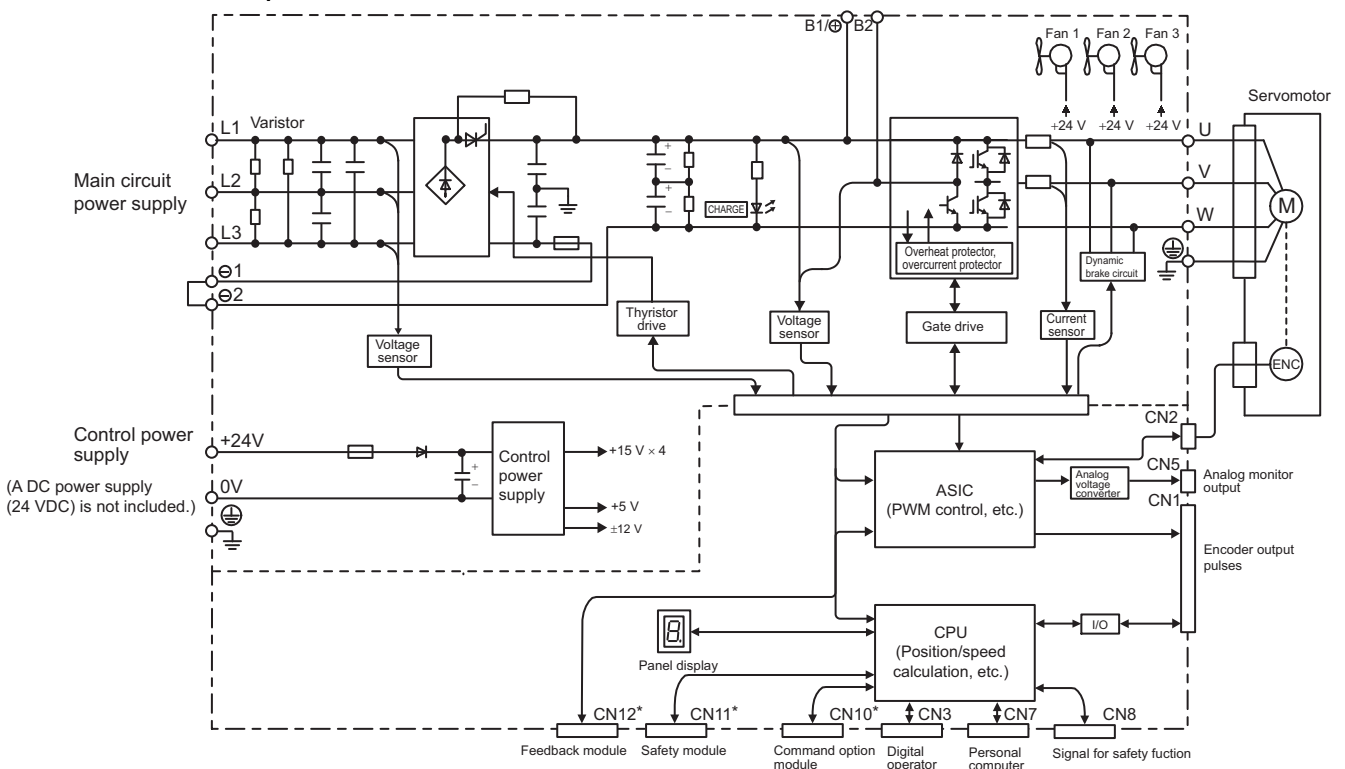

* This external input signal is used by the option module.
For details, refer to the manual of the connected option module.

1.6 Examples of Servo System Configurations

This section describes examples of basic servo system configuration.

1.6.1 Connecting to SGDV-□□□FE1A SERVOPACK

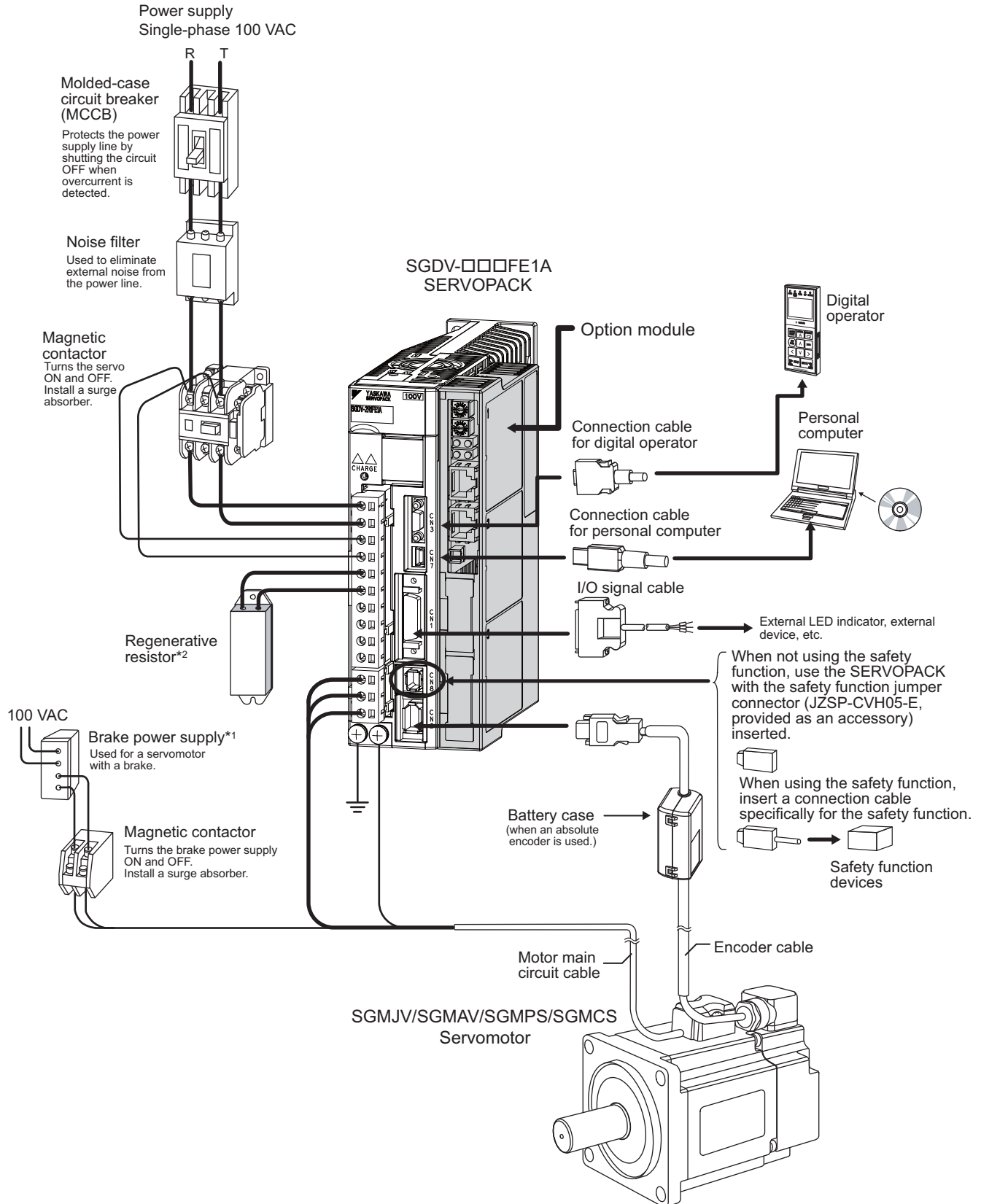

*1. Use a 24-VDC power supply. (not included.)

*2. Before connecting an external regenerative resistor to the SERVOPACK, refer to 3.7 *Regenerative Resistors Connections*.

1.6.2 Connecting to SGD□□□AE1A SERVOPACK

(1) Using a Three-phase, 200-V Power Supply

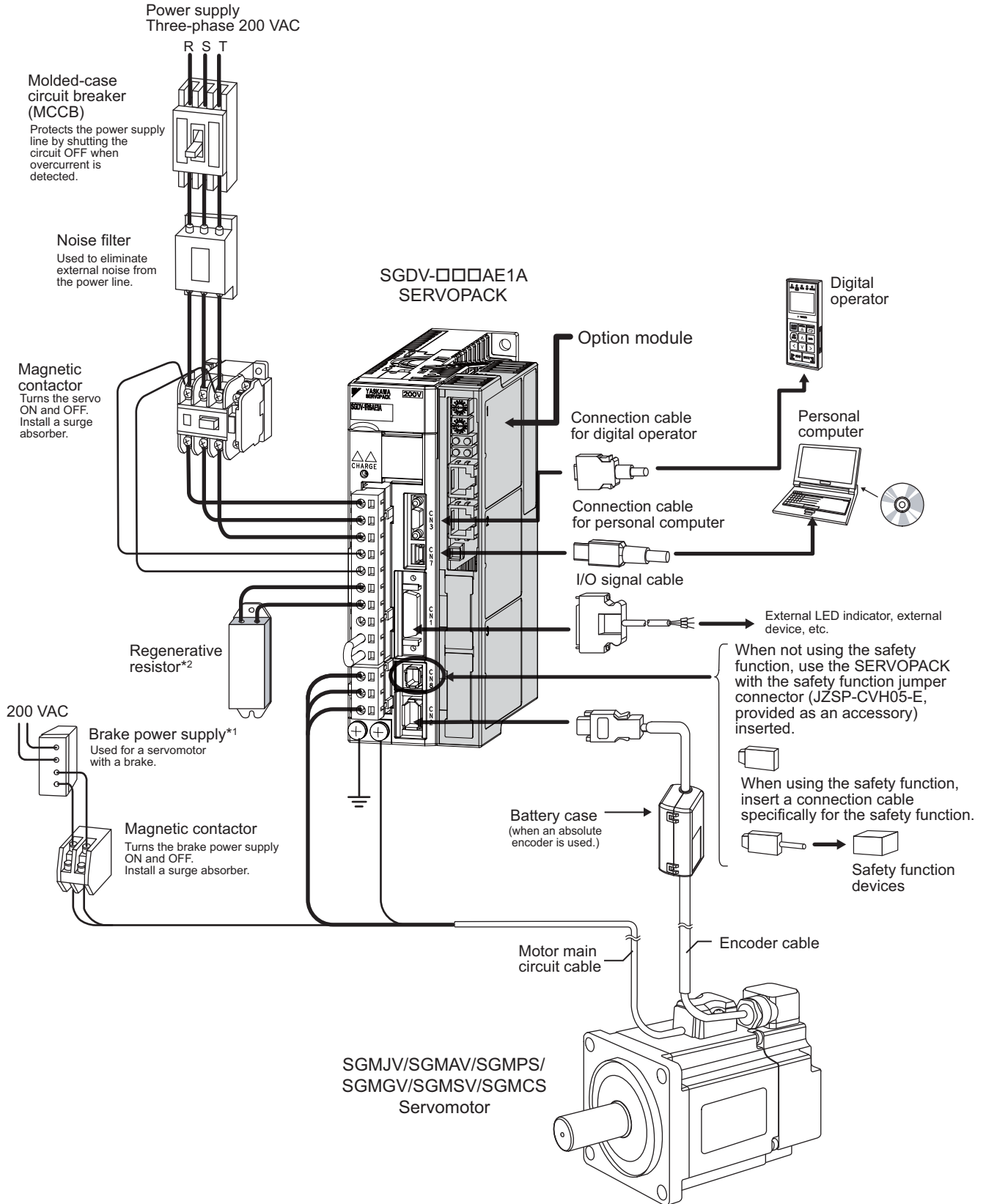

*1. Use a 24-VDC power supply. (not included.)

*2. Before connecting an external regenerative resistor to the SERVOPACK, refer to 3.7 *Regenerative Resistors Connections*.

(2) Using a Single-phase, 200-V Power Supply

The Σ -V Series SERVOPACK for a 200-V power supply input has input specifications for a three-phase power supply, but some models can also be used with a single-phase 200-V power supply. For details, refer to 3.1.3 *Using the SERVOPACK with Single-phase, 200-V Power Input*.

Power supply
Single-phase 200 VAC

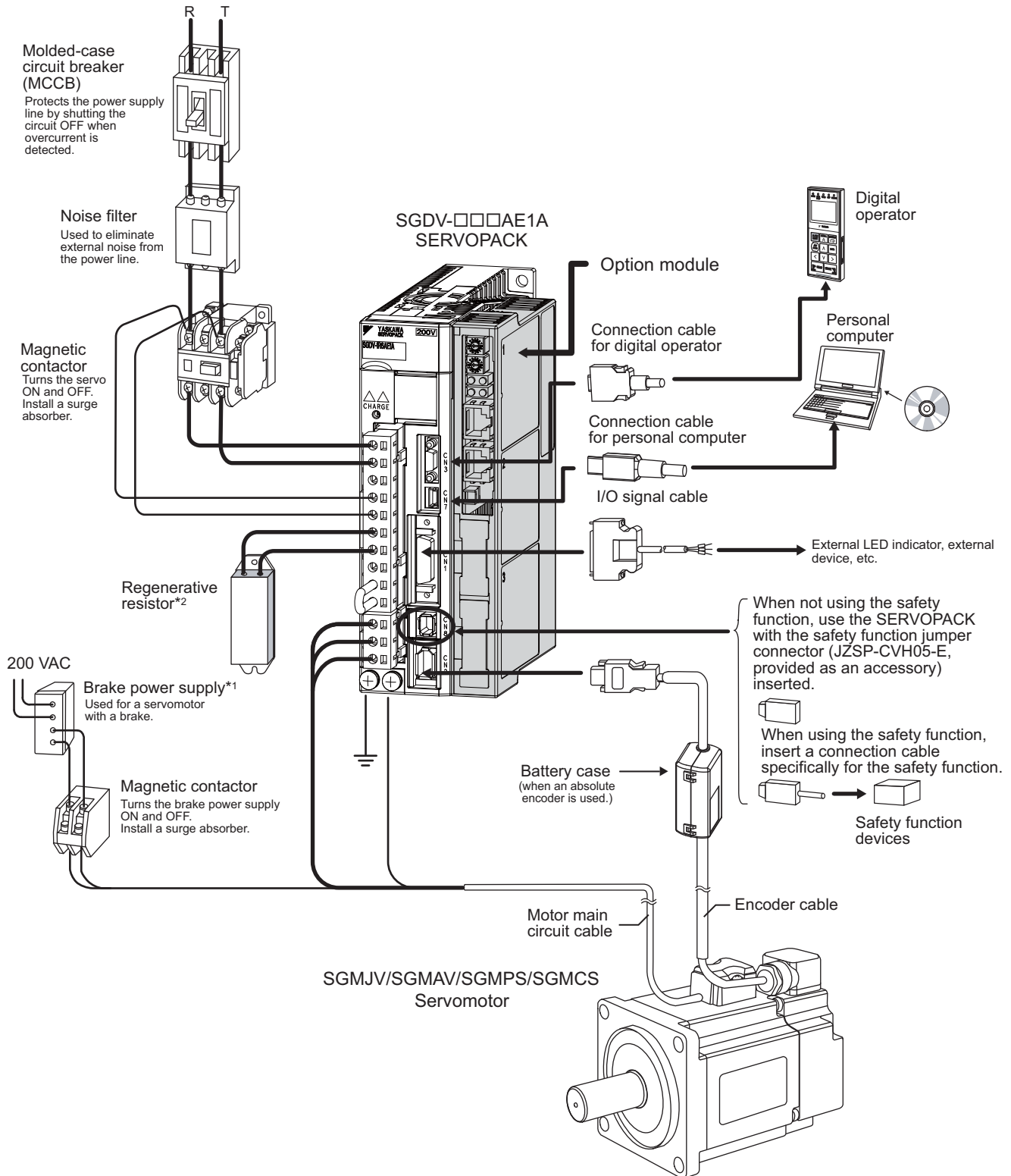

*1. Use a 24-VDC power supply. (not included.)

*2. Before connecting an external regenerative resistor to the SERVOPACK, refer to 3.7 *Regenerative Resistors Connections*.

1.6.3 Connecting to SGD□□□DE1A SERVOPACK

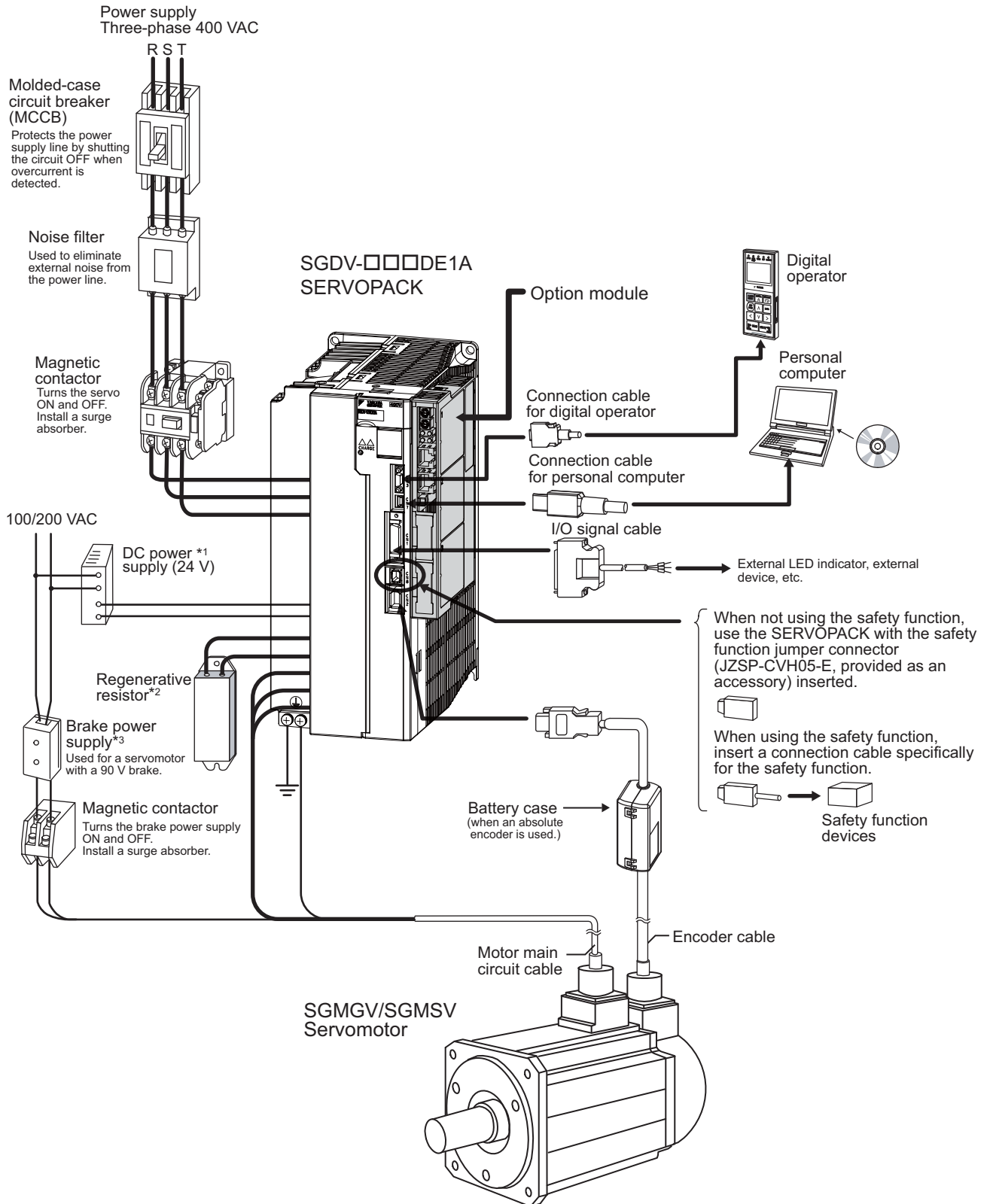

- *1. Use a 24-VDC power supply with double insulation or reinforced insulation. (The power supply is not included)
- *2. Before connecting an external regenerative resistor to the SERVOPACK, refer to 3.7 *Regenerative Resistors Connections*.
- *3. Use a following power supply for 90-V brake. For details, refer to *Σ-V series Product Catalog* (KAEP S800000 42).
 - For 200-V input voltage: LPSE-2H01-E
 - For 100-V input voltage: LPDE-1H01-E

1.7 SERVOPACK Model Designation

Select the SERVOPACK according to the applied servomotor.

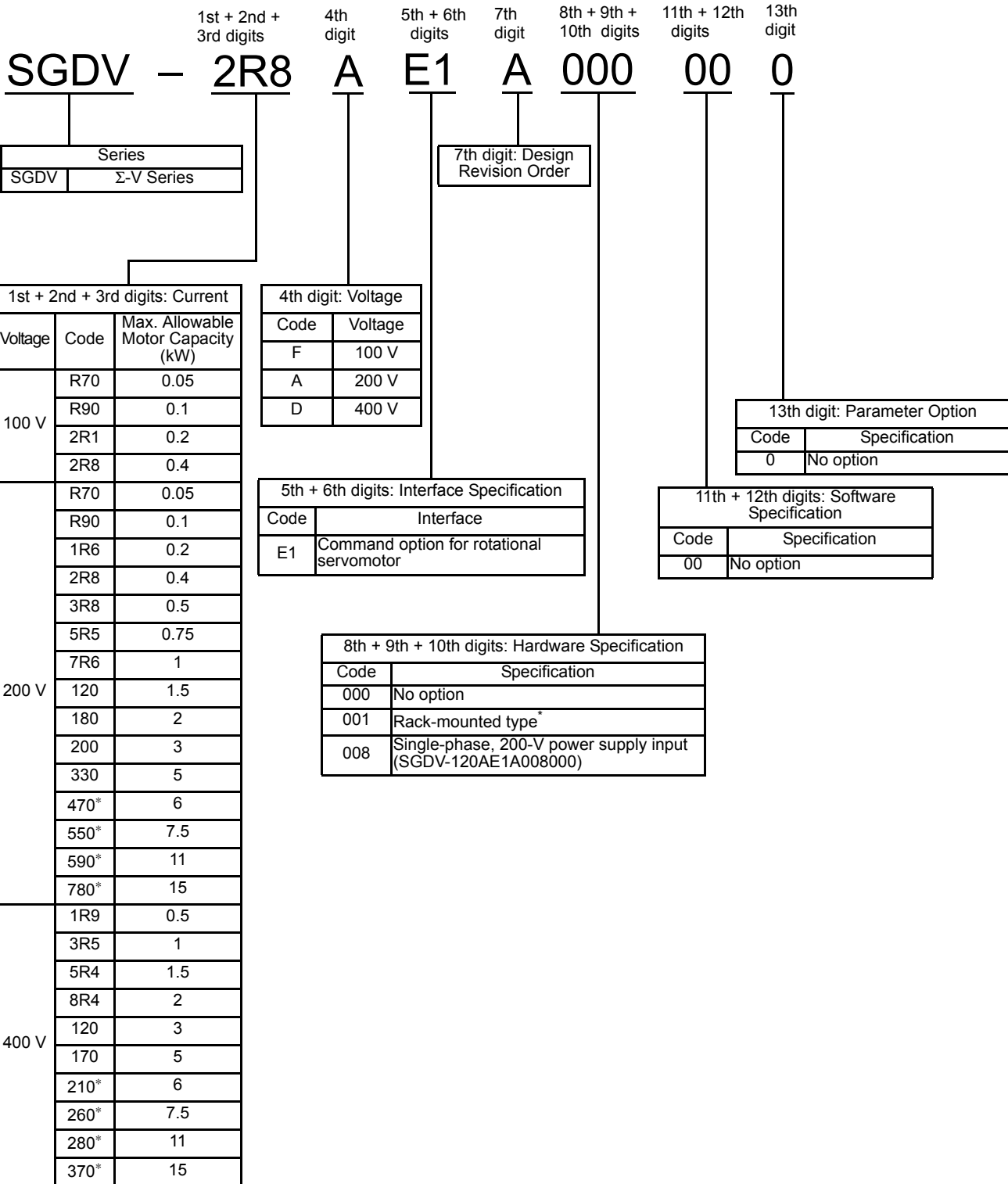

* The SGDV-470A, 550A, 590A, 780A, 210D, 260D, 280D, and 370D have air ducts for ventilation.
 Note: If the option codes for the 8th to the 13th digits are all zero, the zeroes are omitted.

1.8 Inspection and Maintenance

This section describes the inspection and maintenance of SERVOPACK.

(1) SERVOPACK Inspection

For inspection and maintenance of the SERVOPACK, follow the inspection procedures in the following table at least once every year. Other routine inspections are not required.

Item	Frequency	Procedure	Comments
Exterior	At least once a year	Check for dust, dirt, and oil on the surfaces.	Clean with compressed air.
Loose Screws		Check for loose terminal block and connector screws.	Tighten any loose screws.

(2) SERVOPACK's Parts Replacement Schedule

The following electric or electronic parts are subject to mechanical wear or deterioration over time. To avoid failure, replace these parts at the frequency indicated.

Refer to the standard replacement period in the following table, contact your Yaskawa representative. After an examination of the part in question, we will determine whether the parts should be replaced or not.

 IMPORTANT	<p>The parameters of any SERVOPACKs overhauled by Yaskawa are reset to the factory settings before shipping. Be sure to confirm that the parameters are properly set before starting operation.</p>
--	---

Part	Standard Replacement Period	Operating Conditions
Cooling Fan	4 to 5 years	<ul style="list-style-type: none"> Surrounding Air Temperature: Annual average of 30°C Load Factor: 80% max. Operation Rate: 20 hours/day max.
Smoothing Capacitor	7 to 8 years	
Other Aluminum Electrolytic Capacitor	5 years	
Relays	–	
Fuses	10 years	

Panel Display and Operation of Digital Operator





2.1 Panel Display	2-2
2.1.1 Status Display	2-2
2.1.2 Alarm and Warning Display	2-2
2.1.3 Hard Wire Base Block Display	2-2
2.1.4 Displays during Overtravel	2-2
2.2 Utility Function Mode (Fn□□□)	2-3
2.3 Parameter (Pn□□□) Operation	2-4
2.3.1 Parameter Classifications	2-4
2.3.2 Parameter Notation	2-4
2.3.3 Parameter Setting Methods	2-5
2.4 Monitor Mode (Un□□□)	2-7

2.1 Panel Display

The servo status can be checked on the panel display of the SERVOPACK.
Also, if an alarm or warning occurs, its alarm or warning number is displayed.

2.1.1 Status Display

The display shows the following status.

Display	Meaning
	Rotation Detection (/TGON) Lights if motor speed exceeds the value set in Pn502. (Factory setting: 20 min ⁻¹)
	Base Block Lights for base block.
	Reference Input Lights when a reference is being input.
	Command Option Module Communications Status Display Lights when communications with the command option module are normal.

2.1.2 Alarm and Warning Display

If an alarm or warning occurs, the display will change in the following order.

Example: Alarm A.E60

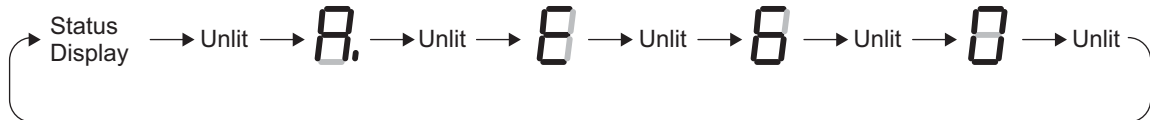

2.1.3 Hard Wire Base Block Display

If a hard wire base block (HWBB) occurs, the display will change in the following order.

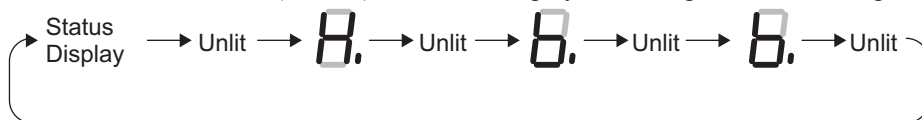

2.1.4 Displays during Overtravel

The display will change as shown below during overtravel.

Forward run prohibited (P-OT signal input ON):

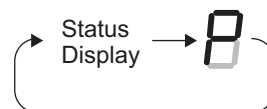

Reverse run prohibited (N-OT signal input ON):



Forward/reverse run prohibited (P-OT/N-OT signal input ON):

























2.2 Utility Function Mode (Fn□□□)

The setup and adjustment functions of the SERVOPACK are executed in this mode.

The digital operator displays numbers beginning with Fn.

An operation example in Utility Function Mode is shown below for Origin Search (Fn003).

Step	Display after Operation	Keys	Description									
1	<pre>BB -FUNCTION- Fn002: JOG Fn003: Z-Search Fn004: Program JOG Fn005: Prm Init</pre>	  	Open the Utility Function Mode main menu and select Fn003.									
2	<pre>BB -Z-Search- Un000= 00000 Un002= 00000 Un003= 00774 Un00D= 00000000</pre>		<p>Press the  Key.</p> <p>The display changes to the execution display of Fn003. If the display does not change and “NO-OP” is displayed in the status display, change the following settings.</p> <ul style="list-style-type: none"> • If Write Prohibited is set in Fn010: → Change the Write Prohibited setting. • If a servo ON command has been entered: → Send a servo OFF command. 									
3	<pre>RUN -Z-Search- Un000= 00000 Un002= 00000 Un003= 00774 Un00D= 00000000</pre>		<p>Press the  Key.</p> <p>“RUN” is displayed in the status display, and power will be applied to the servomotor.</p> <p>If “NO-OP” is displayed, one of the following statuses will be displayed:</p> <ul style="list-style-type: none"> • Main circuit power supply OFF • Alarm • Hard wire base block 									
4	<pre>RUN -Complete- Un000= 00000 Un002= 00000 Un003= 00000 Un00D= 00001D58</pre>	 	<p>Pressing the  Key will rotate the motor in the forward direction. Pressing the  Key will rotate the motor in the reverse direction. The rotation of the servomotor changes according to the setting of Pn000.0.</p> <table border="1"> <thead> <tr> <th>Parameter</th> <th> key (Forward)</th> <th> key (Reverse)</th> </tr> </thead> <tbody> <tr> <td>Pn000</td> <td>n.□□□0</td> <td>CW</td> </tr> <tr> <td></td> <td>n.□□□1</td> <td>CCW</td> </tr> </tbody> </table> <p>Note: Direction when viewed from the load of the servomotor.</p> <p>Press the  or  Key until the motor stops. If the origin search completed normally, “-Complete-” is displayed in the upper right corner.</p>	Parameter	 key (Forward)	 key (Reverse)	Pn000	n.□□□0	CW		n.□□□1	CCW
Parameter	 key (Forward)	 key (Reverse)										
Pn000	n.□□□0	CW										
	n.□□□1	CCW										
5	<pre>BB -Z-Search- Un000= 00000 Un002= 00000 Un003= 00774 Un00D= 00001D58</pre>		<p>When the origin search is completed, press the  Key.</p> <p>“BB” is displayed in the status display, and the servomotor turns OFF. The display “-Complete-” changes to “-Z-Search-” in the upper right corner.</p>									
6	<pre>BB -FUNCTION- Fn002: JOG Fn003: Z-Search Fn004: Program JOG Fn005: Prm Init</pre>		<p>Press the  Key.</p> <p>The display returns to the Utility Function Mode main menu.</p> <p>This completes the operation.</p>									

2.3 Parameter (Pn□□□) Operation

This section describes the classifications, notation, and setting methods of parameters given in this manual.

2.3.1 Parameter Classifications

The Σ-V-series SERVOPACKs have two types of parameters: setup parameters for the basic settings required for operation and tuning parameters for adjusting servo performance.

Classification	Meaning	Display Method	Setting Method
Setup parameters	Parameters required for setup	Normally displayed. (Pn00B.0 = 0, factory setting)	Set each parameter.
Tuning parameters	Parameters for tuning of control gain and other values	Set Pn00B.0 to 1.	The user is generally not required to set these parameters individually.

Also, there are two notation methods for parameters: “numeric parameters” for which numeric values are set and “selection parameters” for which functions are selected.

The following sections describe each explanation method and setting method.

2.3.2 Parameter Notation

(1) Notation for Numeric Parameters

Control mode for which the parameter is valid.

Speed : Speed control

Position : Position control

Torque : Torque control

Pn406	Emergency Stop Torque			<input type="checkbox"/> Speed	<input type="checkbox"/> Position	<input type="checkbox"/> Torque
	Setting Range	Setting Unit	Factory Setting	When Enabled	Classification	
	0 to 800%	1%	800%	Immediately	Setup	

The number of the parameter.

Indicates setting range for the parameter.

Indicates minimum setting unit for the parameter.

Indicates parameter value before shipment (factory setting).

Indicates if the power has to be turned OFF and ON again to validate setting changes.

Indicates the parameter classification.

(2) Notation for Selection Parameters

Parameter	Meaning	When Enabled	Classification
Pn50A	n.2□□□	After restart	Setup
	n.8□□□		

The number of the parameter.





























n.□□□□ indicates the function selection. The numbers in the boxes indicate the set values for each digit. This example indicates the 4th digit is 8.

This section explains the details of the function selection.

2.3.3 Parameter Setting Methods





















(1) Setting Method for Numeric Parameters

The following example shows how to change the setting of parameter Pn304 (JOG speed) to 1000 min⁻¹.

Step	Display after Operation	Keys	Description
1	<pre>BB -PRM/MON- Un000= 00000 Un002= 00000 Un008= 00000 Un00D=00000000</pre>		Press the  Key to select the Parameter/Monitor Mode.
2	<pre>BB -PRM/MON- Un000= 00000 Un002= 00000 Un008= 00000 Un00D=00000000</pre>	 	Press the  or  Key to move the cursor to “Un.”
3	<pre>BB -PRM/MON- Pn000=n.0000 Un002= 00000 Un008= 00000 Un00D=00000000</pre>	 	Press the  or  Key to change “Un” to “Pn.”
4	<pre>BB -PRM/MON- Pn000=n.0000 Un002= 00000 Un008= 00000puls e Un00D=00000000</pre>		Press the  Key to move the cursor to the column on the right of “Pn.”
5	<pre>BB -PRM/MON- Pn304=00500 Un002= 00000 Un008= 00000 Un00D=00000000</pre>	   	Press the arrow keys to display “Pn304”. To move the cursor:  ,  Key To change the settings:  ,  Key
6	<pre>BB -PRM/MON- Pn304=0050<u>0</u> Un002= 00000 Un008= 00000 Un00D=00000000</pre>		Press the  Key to move the cursor to the one’s place of Pn304.
7	<pre>BB -PRM/MON- Pn304=00<u>5</u>00 Un002= 00000 Un008= 00000 Un00D=00000000</pre>		Press the  Key twice to move the cursor to the hundred’s place of Pn304.
8	<pre>BB -PRM/MON- Pn304=01<u>0</u>00 Un002= 00000 Un008= 00000 Un00D=00000000</pre>		Press the  Key five times to change the setting to “1000.”
9	<pre>BB -PRM/MON- Pn304=01000 Un002= 00000 Un008= 00000 Un00D=00000000</pre>		Press the  Key to write the settings.

(2) Setting Method for Selection Parameters

The following example shows how to use application function selection switch 1 (Pn001) to change the setting for the stopping method at servo OFF and alarm occurrence from stopping using DB (Pn001 = n.0000) to stopping without DB (Pn001 = n.0002).

Step	Display after Operation	Keys	Description
1	<pre> BB -PRM/MON- Un00<u>0</u>= 00000 Un002= 00000 Un008= 00000 Un00D=00000000 </pre>		Press the  Key to select the Parameter/Monitor Mode.
2	<pre> BB -PRM/MON- <u>Un</u>000= 00000 Un002= 00000 Un008= 00000 Un00D=00000000 </pre>	 	Press the  or  Key to move the cursor to "Un."
3	<pre> BB -PRM/MON- <u>Pn</u>000=n.0000 Un002= 00000 Un008= 00000 Un00D=00000000 </pre>	 	Press the  or  Key to change "Un" to "Pn."
4	<pre> BB -PRM/MON- Pn00<u>0</u>=n.0000 Un002= 00000 Un008= 00000 Un00D=00000000 </pre>		Press the  Key three times to move the cursor to the left of "=".
5	<pre> BB -PRM/MON- Pn00<u>1</u>=n.0000 Un002= 00000 Un008= 00000 Un00D=00000000 </pre>		Press the  Key to display "Pn001."
6	<pre> BB -PRM/MON- Pn001=n.000<u>0</u> Un002= 00000 Un008= 00000 Un00D=00000000 </pre>		Press the  Key to move the cursor to the right edge.
7	<pre> BB -PRM/MON- Pn001=n.000<u>2</u> Un002= 00000 Un008= 00000 Un00D=00000000 </pre>		Press the  Key twice to change the setting of "n.0000" to "n.0002."
8	<pre> BB -PRM/MON- Pn001=n.000<u>2</u> Un002= 00000 Un008= 00000 Un00D=00000000 </pre>		Press the  Key to write the settings.

2.4 Monitor Mode (Un□□□)

The monitor mode can be used for monitoring the reference values, I/O signal status, and SERVOPACK internal status.

For details, refer to *7.2 Monitor Displays*.

The digital operator display numbers begin with Un.

The following four Un numbers are displayed with the factory settings.

BB		-PRM/MON-
Un000	=	00000
Un002	=	00000
Un008	=	00000
Un00D	=	00000000

← Shows the setting of Un000 (motor speed) as 0 min⁻¹.

Wiring and Connection

3.1	Main Circuit Wiring	3-2
3.1.1	Main Circuit Terminals	3-2
3.1.2	Using a Standard Power Supply Input (Single-phase 100-V, Three-phase 200-V, or Three-phase 400-V)	3-3
3.1.3	Using the SERVOPACK with Single-phase, 200-V Power Input	3-12
3.1.4	Using the SERVOPACK with a DC Power Input	3-15
3.1.5	Using More Than One SERVOPACK	3-17
3.1.6	General Precautions for Wiring	3-18
3.2	I/O Signal Connections	3-19
3.2.1	I/O Signal (CN1) Names and Functions	3-19
3.2.2	Safety Function Signal (CN8) Names and Functions	3-20
3.2.3	Example of I/O Signal Connections	3-21
3.3	I/O Signal Allocations	3-22
3.3.1	Input Signal Allocations	3-22
3.3.2	Output Signal Allocation	3-24
3.4	Connection to Host Controller	3-25
3.4.1	Sequence Input Circuits	3-25
3.4.2	Sequence Output Circuits	3-27
3.5	Wiring Communications Using Command Option Modules	3-29
3.6	Encoder Connections	3-30
3.6.1	Encoder Signal (CN2) Names and Functions	3-30
3.6.2	Examples of Encoder Connection	3-30
3.7	Regenerative Resistors Connections	3-32
3.7.1	Connecting Regenerative Resistors	3-32
3.7.2	Setting Regenerative Resistor Capacity	3-34
3.8	Noise Control and Measures for Harmonic Suppression	3-35
3.8.1	Wiring for Noise Control	3-35
3.8.2	Precautions on Connecting Noise Filter	3-37
3.8.3	Connecting AC/DC Reactor for Harmonic Suppression	3-39

3.1 Main Circuit Wiring

The names and specifications of the main circuit terminals are given on the following page.

This section also describes the general precautions for wiring and precautions under special environments.

3.1.1 Main Circuit Terminals

The names and specifications are shown in the following table.

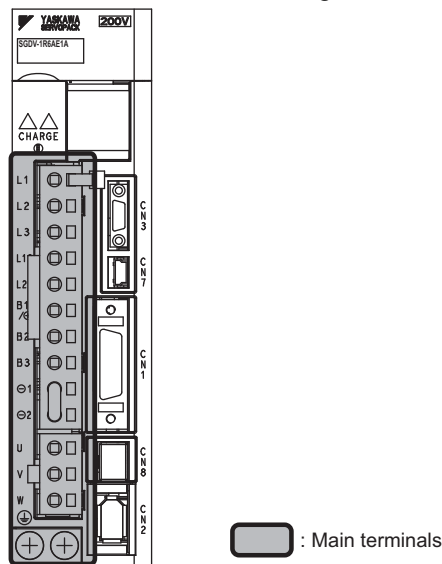

Terminal Symbols	Name	Model SGDV-□□□□	Description
L1, L2	Main circuit input terminals	□□□F	Single-phase 100 to 115 V, +10% to -15% (50/60 Hz)
L1, L2, L3		□□□A	Three-phase 200 to 230 V, +10% to -15% (50/60 Hz)
		□□□D	Three-phase 380 to 480 V, +10% to -15% (50/60 Hz)
L1C, L2C	Control power input terminals	□□□F	Single-phase 100 to 115 V, +10% to -15% (50/60 Hz)
24 V, 0 V		□□□A	Single-phase 200 to 230 V, +10% to -15% (50/60 Hz)
		□□□D	24 VDC, ±15%
B1/ ⊙, B2*1	External regenerative resistor terminals	R70F, R90F, 2R1F, 2R8F, R70A, R90A, 1R6A, 2R8A	If the regenerative capacity is insufficient, connect an external regenerative resistor (option) between B1/ ⊙ and B2.
		3R8A, 5R5A, 7R6A, 120A, 180A, 200A, 330A, 1R9D, 3R5D, 5R4D, 8R4D, 120D, 170D	Remove the lead or short bar that is short-circuiting between B2 and B3, and connect an external regenerative resistor between B1/ ⊙ and B2 only if the internal regenerative capacity is insufficient. Purchase an external regenerative resistor separately.
		470A, 550A, 590A, 780A, 210D, 260D, 280D, 370D	Connect a regenerative resistor unit between B1/ ⊙ and B2. Purchase a regenerative resistor unit separately.
⊙ 1, ⊙ 2*2	DC reactor connection terminal for power supply harmonic suppression	□□□A □□□D	If a countermeasure against power supply harmonic waves is needed, connect a DC reactor between ⊙ 1 and ⊙ 2.

(cont'd)

Terminal Symbols	Name	Model SGD V-□□□□	Description
B1/ ⊕	Main circuit plus terminal	□□□A □□□D	Use when DC power supply input is used.
⊖ 2 or ⊖	Main circuit minus terminal	□□□A □□□D	
U, V, W	Servomotor connection terminals	Use for connecting to the servomotor.	
⊕	Ground terminals (x2)	Use for connecting the power supply ground terminal and servomotor ground terminal.	

*1. Do not short-circuit the B1/ ⊕ and B2 terminals. Doing so may damage the SERVOPACK.

*2. The ⊖ 1 and ⊖ 2 terminals are short-circuited with a jumper at the factory.

3.1.2 Using a Standard Power Supply Input (Single-phase 100-V, Three-phase 200-V, or Three-phase 400-V)

(1) Wire Types

Use the following type of wire for main circuit.

Cable Type		Allowable Conductor Temperature °C
Symbol	Name	
IV	600 V polyvinyl chloride insulated wire	60
HIV	600 V grade heat-resistant polyvinyl chloride insulated wire	75

The following table shows the wire sizes and allowable currents for three wires. Use wires with specifications equal to or less than those shown in the table.

- 600 V grade heat-resistant polyvinyl chloride insulated wire (HIV)

AWG Size	Nominal Cross Section Diameter (mm ²)	Configuration (Number of Wires/mm ²)	Conductive Resistance (Ω/km)	Allowable Current at Surrounding Air Temperature (A)		
				30°C	40°C	50°C
20	0.5	19/0.18	39.5	6.6	5.6	4.5
19	0.75	30/0.18	26.0	8.8	7.0	5.5
18	0.9	37/0.18	24.4	9.0	7.7	6.0
16	1.25	50/0.18	15.6	12.0	11.0	8.5
14	2.0	7/0.6	9.53	23	20	16
12	3.5	7/0.8	5.41	33	29	24
10	5.5	7/1.0	3.47	43	38	31
8	8.0	7/1.2	2.41	55	49	40
6	14.0	7/1.6	1.35	79	70	57
4	22.0	7/2.0	0.85	91	81	66

Note: The values in the table are for reference only.

(2) SERVOPACK Main Circuit Wire

This section describes the wire used for the SERVOPACK main circuit.

 IMPORTANT	<ol style="list-style-type: none"> 1. Wire sizes are selected for three cables per bundle at 40°C surrounding air temperature with the rated current. 2. Use a wire with a minimum withstand voltage of 600 V for the main circuit. 3. If wires are bundled in PVC or metal ducts, take into account the reduction of the allowable current. 4. Use a heat-resistant wire under high surrounding air or panel temperatures, where polyvinyl chloride insulated wires will rapidly deteriorate.
---	--

■ Single-phase, 100 V

Terminal Symbols	Name	SERVOPACK Model SGD□V-□□□F			
		R70	R90	2R1	2R8
L1, L2	Main circuit power input terminals	HIV1.25		HIV2.0	
L1C, L2C	Control power input terminals	HIV1.25			
U, V, W	Servomotor connection terminals	HIV1.25			
B1/⊕, B2	External regenerative resistor connection terminals	HIV1.25			
⊕	Ground terminal	HIV2.0 or higher			

■ Three-phase, 200 V

Terminal Symbols	Name	SERVOPACK Model SGD□V-□□□A														
		R70	R90	1R6	2R8	3R8	5R5	7R6	120	180	200	330	470	550	590	780
L1, L2, L3	Main circuit power input terminals	HIV1.25			HIV2.0				HIV3.5		HIV5.5	HIV8.0	HIV14.0	HIV22.0		
L1C, L2C	Control power input terminals	HIV1.25														
U, V, W	Servomotor connection terminals	HIV1.25			HIV2.0				HIV3.5	HIV5.5	HIV8.0	HIV14.0		HIV22.0		
B1/⊕, B2	External regenerative resistor connection terminals	HIV1.25							HIV2.0	HIV3.5	HIV5.5	HIV8.0		HIV22.0		
⊕	Ground terminal	HIV2.0 or higher														

■ Three-phase, 400 V

Terminal Symbols	Name	SERVOPACK Model SGD□V-□□□D										
		1R9	3R5	5R4	8R4	120	170	210	260	280	370	
L1, L2, L3	Main circuit power input terminals	HIV1.25			HIV2.0			HIV3.5		HIV5.5	HIV8.0	HIV14.0
24 V, 0 V	Control power input terminals	HIV1.25										
U, V, W	Servomotor connection terminals	HIV1.25			HIV2.0			HIV3.5	HIV5.5		HIV8.0	HIV14.0
B1/⊕, B2 (B1, B2)	External regenerative resistor connection terminals	HIV1.25					HIV2.0	HIV3.5		HIV5.5	HIV8.0	
⊕	Ground terminal	HIV2.0 or higher										

(3) Typical Main Circuit Wiring Examples

Note the following points when designing the power ON sequence.

- Design the power ON sequence so that main power is turned OFF when a servo alarm signal is output.
- The ALM signal is output for five seconds max. (1Ry is OFF) when the power is turned ON. Take this into consideration when designing the power ON sequence. Also, use this relay to turn off the main power for the SERVOPACK.

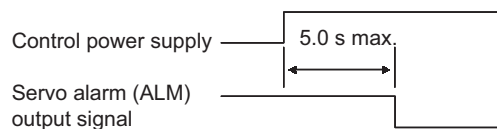

- Select the power supply specifications for the parts in accordance with the input power supply.



IMPORTANT

- When turning ON the control power supply and the main circuit power supply, turn them ON at the same time or after the control power supply. When turning OFF the power supplies, first turn the power for the main circuit OFF and then turn OFF the control power supply.

The typical main circuit wiring examples are shown below.



WARNING

- Do not touch the power terminals after turning OFF the power. High voltage may still remain in the SERVOPACK. When the voltage is discharged, the charge indicator will turn OFF. Make sure the charge indicator is OFF before starting wiring or inspections.

■ Single-phase 100 V, SGDV-□□□F (SGDV-R70F, R90F, 2R1F, 2R8F)

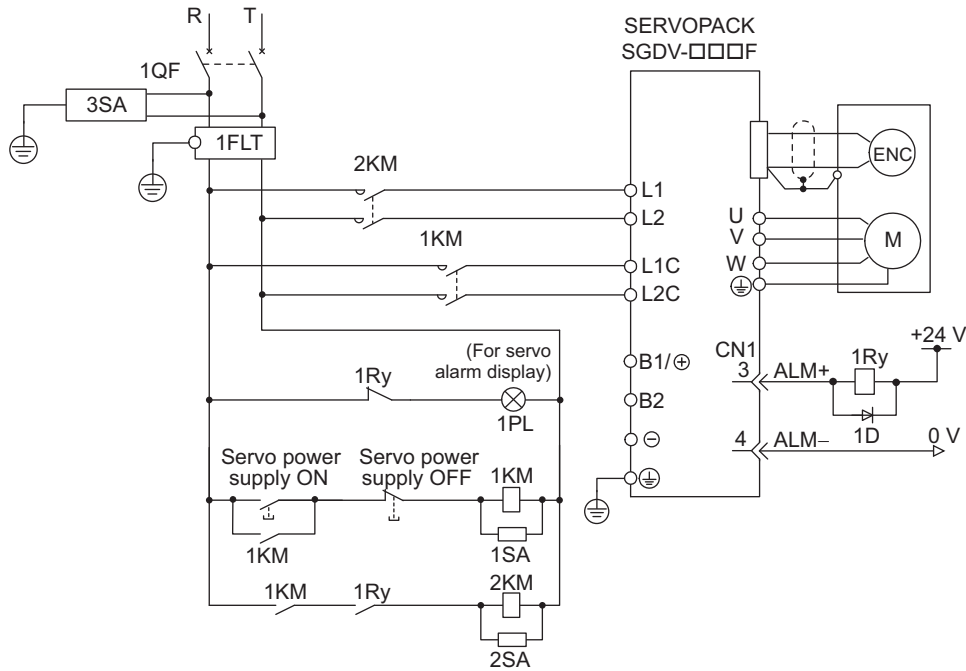

- | | |
|--|---------------------|
| 1QF: Molded-case circuit breaker | 1PL: Indicator lamp |
| 1FLT: Noise filter | 1SA: Surge absorber |
| 1KM: Magnetic contactor (for control power supply) | 2SA: Surge absorber |
| 2KM: Magnetic contactor (for main power supply) | 3SA: Surge absorber |
| 1Ry: Relay | 1D: Flywheel diode |

■ Three-phase 200 V, SGDV-□□□A

- SGDV-R70A, R90A, 1R6A, 2R8A, 3R8A, 5R5A, 7R6A, 120A, 180A, 200A, 330A

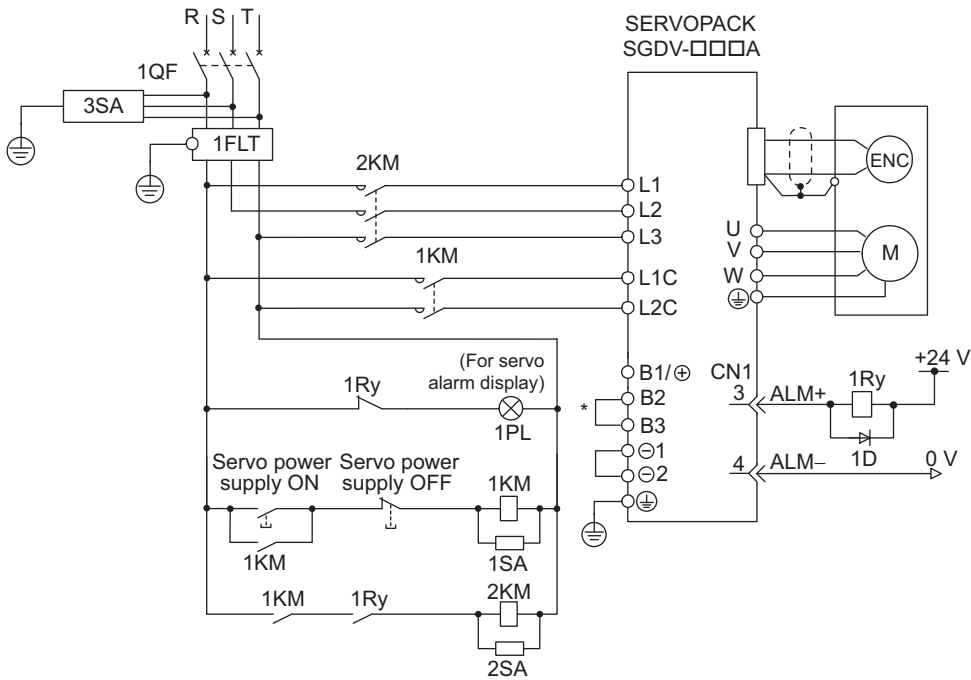

- | | |
|--|---------------------|
| 1QF: Molded-case circuit breaker | 1PL: Indicator lamp |
| 1FLT: Noise filter | 1SA: Surge absorber |
| 1KM: Magnetic contactor (for control power supply) | 2SA: Surge absorber |
| 2KM: Magnetic contactor (for main power supply) | 3SA: Surge absorber |
| 1Ry: Relay | 1D: Flywheel diode |

* For SGDV-R70A, -R90A, -1R6A, -2R8A, terminals B2 and B3 are not short-circuited. Do not short-circuit these terminals.

- SGDV-470A, 550A, 590A, 780A

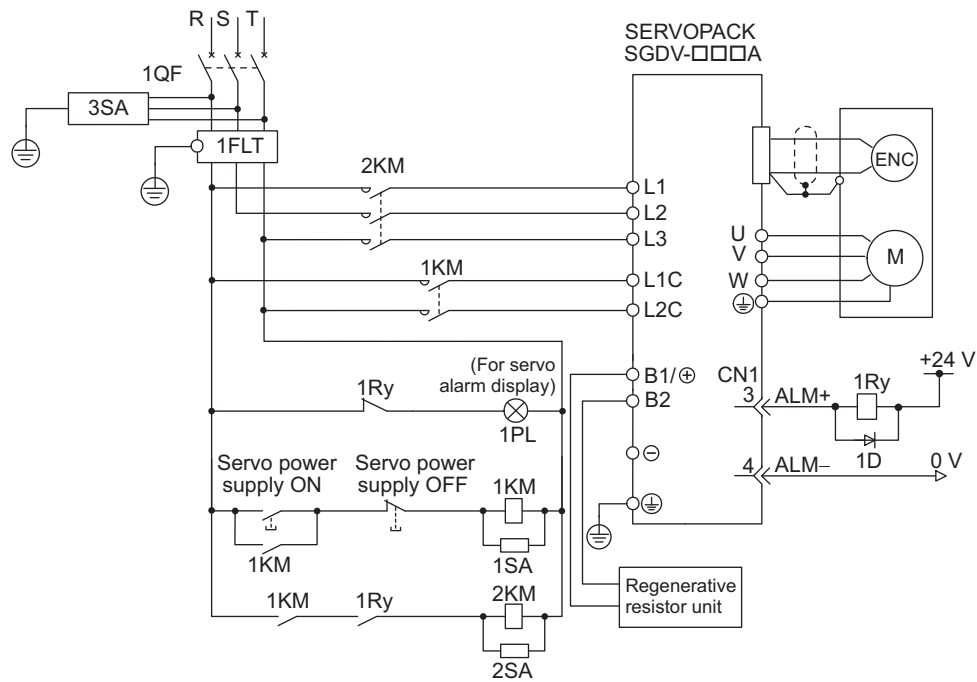

- | | |
|--|---------------------|
| 1QF: Molded-case circuit breaker | 1PL: Indicator lamp |
| 1FLT: Noise filter | 1SA: Surge absorber |
| 1KM: Magnetic contactor (for control power supply) | 2SA: Surge absorber |
| 2KM: Magnetic contactor (for main power supply) | 3SA: Surge absorber |
| 1Ry: Relay | 1D: Flywheel diode |

■ Three-phase 400 V, SGDV-□□□D

- SGDV-1R9D, 3R5D, 5R4D, 8R4D, 120D, 170D

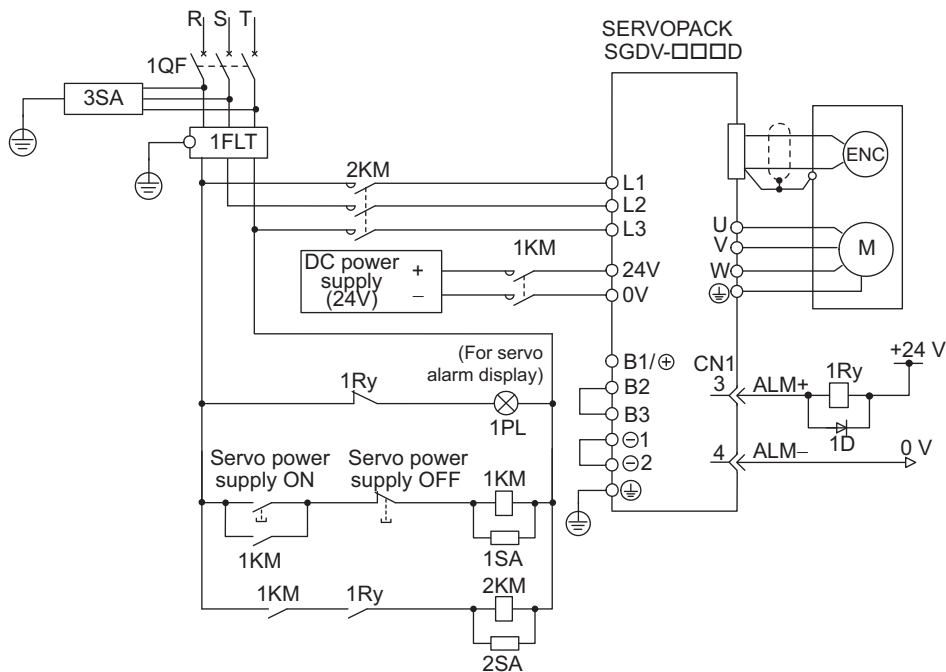

- | | |
|--|---------------------|
| 1QF: Molded-case circuit breaker | 1PL: Indicator lamp |
| 1FLT: Noise filter | 1SA: Surge absorber |
| 1KM: Magnetic contactor (for control power supply) | 2SA: Surge absorber |
| 2KM: Magnetic contactor (for main power supply) | 3SA: Surge absorber |
| 1Ry: Relay | 1D: Flywheel diode |

3.1.2 Using a Standard Power Supply Input (Single-phase 100-V, Three-phase 200-V, or Three-phase 400-V)

- SGD V-210D, 260D, 280D, 370D

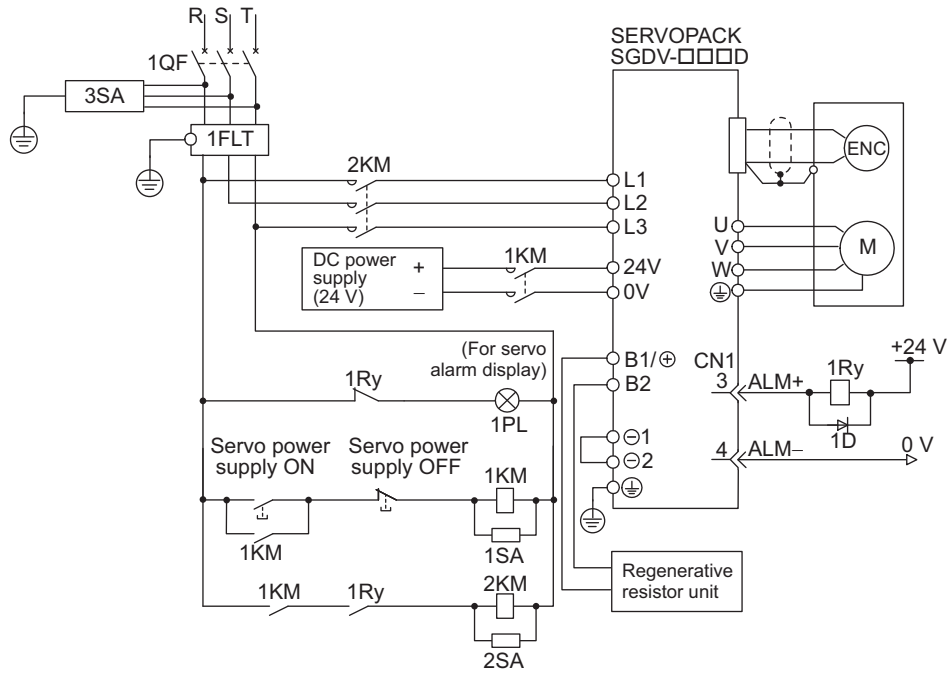

- | | |
|--|---------------------|
| 1QF: Molded-case circuit breaker | 1PL: Indicator lamp |
| 1FLT: Noise filter | 1SA: Surge absorber |
| 1KM: Magnetic contactor (for control power supply) | 2SA: Surge absorber |
| 2KM: Magnetic contactor (for main power supply) | 3SA: Surge absorber |
| 1Ry: Relay | 1D: Flywheel diode |

(4) Power Supply Capacities and Power Losses

The following table gives the power capacities and power losses of the SERVOPACK.

Main Circuit Power Supply	Maximum Applicable Motor Capacity [kW]	SERVO-PACK Model SGD V-	Power Supply Capacity per SERVOPACK [kVA]	Output Current [Arms]	Main Circuit Power Loss [W]	Regenerative Resistor Power Loss [W]	Control Circuit Power Loss [W]	Total Power Loss [W]
Single-phase, 100-V	0.05	R70F	0.2	0.66	5.4	-	17	22.4
	0.1	R90F	0.3	0.91	7.8			24.8
	0.2	2R1F	0.7	2.1	14.4			31.4
	0.4	2R8F	1.4	2.8	25.6			42.6
Three-phase, 200-V	0.05	R70A	0.2	0.66	5.1	-	17	22.1
	0.1	R90A	0.3	0.91	7.3			24.3
	0.2	1R6A	0.6	1.6	13.5			30.5
	0.4	2R8A	1	2.8	24.0			41.0
	0.5	3R8A	1.4	3.8	20.1	8	17	45.1
	0.75	5R5A	1.6	5.5	43.8			68.8
	1.0	7R6A	2.3	7.6	53.6	10	22	78.6
	1.5	120A	3.2	11.6	65.8			97.8
	2.0	180A	4	18.5	111.9	16	27	149.9
	3.0	200A	5.9	19.6	113.8			161.4
	5.0	330A	7.5	32.9	263.7	36	27	326.7
	6.0	470A	10.7	46.9	279.4	(180) *1	33	312.4
	7.5	550A	14.6	54.7	357.8	(350) *2		390.8
	11	590A	21.7	58.6	431.7		479.7	
15	780A	29.6	78	599.0	647.0			
Three-phase, 400-V	0.5	1R9D	1.1	1.9	24.6	14	21	59.6
	1.0	3R5D	2.3	3.5	46.1			81.1
	1.5	5R4D	3.5	5.4	71.3			106.3
	2.0	8R4D	4.5	8.4	77.9	28	25	130.9
	3.0	120D	7.1	11.9	108.7			161.7
	5.0	170D	11.7	16.5	161.1	36	24	221.1
	6.0	210D	12.4	20.8	172.7	(180) *3	27	199.7
	7.5	260D	14.4	25.7	218.6			245.6
	11	280D	21.9	28.1	294.6	(350) *4	30	324.6
	15	370D	30.6	37.2	403.8			433.8

*1. For the optional JUSP-RA04-E regenerative resistor unit.

*2. For the optional JUSP-RA05-E regenerative resistor unit.

*3. For the optional JUSP-RA18-E regenerative resistor unit.

*4. For the optional JUSP-RA19-E regenerative resistor unit.

Note 1. SGD V-R70F, -R90F, -2R1F, -2R8F, -R70A, -R90A, -1R6A, and -2R8A SERVOPACKs do not have built-in regenerative resistors. If the regenerative energy exceeds the specified value, connect an external regenerative resistor (optional).

2. SGD V-470A, -550A, -590A, -780A, -210D, -260D, -280D, -370D SERVOPACKs do not have built-in regenerative resistors. Be sure to connect a regenerative resistor unit (optional) or an external regenerative resistor (optional). For selection details, refer to 3.7 *Regenerative Resistors Connections*.

3. Regenerative resistor power losses are allowable losses. Take the following action if the actual power loss exceeds the allowable power loss.

- Remove the lead or short bar that is short-circuiting the SERVOPACK main circuit terminal B2 and B3. (SGD V-3R8A, -5R5A, -7R6A, -120A, -180A, -200A, -330A, or 400-V class SERVOPACKs.)
- Install an external regenerative resistor (optional). For selection details, refer to 3.7 *Regenerative Resistors Connections*.

(5) Molded-case Circuit Breaker and Fuse Capacities

The following table describes the molded-case circuit breaker and fuse capacities of the SERVOPACK.

Main Circuit Power Supply	Maximum Applicable Motor Capacity [kW]	SERVOPACK Model SGD V-	Power Supply Capacity per SERVOPACK [kVA]	Current Capacity		Inrush Current	
				Main Circuit [Arms]	Control Circuit [Arms]	Main Circuit [A0-p]	Control Circuit [A0-p]
Single-phase, 100-V	0.05	R70F	0.2	1.5	0.38	16.5	35
	0.1	R90F	0.3	2.5			
	0.2	2R1F	0.7	5			
	0.4	2R8F	1.4	10			
Three-phase, 200-V	0.05	R70A	0.2	1.0	0.2	33	70
	0.1	R90A	0.3	1.0			
	0.2	1R6A	0.6	2.0			
	0.4	2R8A	1	3.0			
	0.5	3R8A	1.4	3.0			
	0.75	5R5A	1.6	6.0			
	1.0	7R6A	2.3	6.0	0.25	33	33
	1.5	120A	3.2	7.3			
	2.0	180A	4	9.7			
	3.0	200A	5.9	15			
	5.0	330A	7.5	25	0.3	65.5	33
	6.0	470A	10.7	29			
	7.5	550A	14.6	37			
	11	590A	21.7	54	0.45	109	48
15	780A	29.6	73				
Three-phase, 400-V	0.5	1R9D	1.1	1.4	1.2	17	-
	1.0	3R5D	2.3	2.9			
	1.5	5R4D	3.5	4.3			
	2.0	8R4D	4.5	5.8	1.4	34	
	3.0	120D	7.1	8.6			
	5.0	170D	11.7	14.5		1.5	
	6.0	210D	12.4	17.4			
	7.5	260D	14.4	21.7			
	11	280D	21.9	31.8	1.7		
15	370D	30.6	43.4				

Note 1. To comply with the low voltage directive, connect a fuse to the input side. Select the fuse or molded-case circuit breaker for the input side from among models that are compliant with UL standards.

The table above also provides the net values of current capacity and inrush current. Select a fuse and a molded-case circuit breaker which meet the breaking characteristics shown below.

- Main circuit, control circuit: No breaking at three-times the current values of the table for 5 s.
- Inrush current: No breaking at the same current values of the table for 20 ms.

2. In accordance with UL standards, the following restrictions apply.

SERVOPACK Model SGD V-	Restrictions
180A, 200A	Available rated current for molded-case circuit breaker: 40 A or less
330A	<ul style="list-style-type: none"> • Available rated current for non-time delay fuse: 70 A or less • Available rated current for time delay fuse: 40 A or less • Do not use signal wires.

(cont'd)

SERVOPACK Model SGD V-	Restrictions
470A, 550A	<ul style="list-style-type: none"> • Available rated current for molded-case circuit breaker: 60 A or less • Available rated current for non-time delay fuse or time delay fuse: 60 A or less
590A, 780A	<ul style="list-style-type: none"> • Available rated current for molded-case circuit breaker: 100 A or less • Available rated current for non-time delay fuse or time delay fuse: 100 A or less (Available rated current for class J non-time delay or faster fuse: 125 A or less)
210D, 260D	<ul style="list-style-type: none"> • Available rated current for molded-case circuit breaker: 60 A or less • Available rated current for non-time delay fuse: 60 A or less • Available rated current for time delay fuse: 35 A or less
280D, 370D	<ul style="list-style-type: none"> • Available rated current for molded-case circuit breaker: 80 A or less • Available rated current for non-time delay fuse: 125 A or less • Available rated current for time delay fuse: 75 A or less

3.1.3 Using the SERVOPACK with Single-phase, 200-V Power Input

Some models of Σ -V series three-phase 200 V power input SERVOPACK can be used also with a single-phase 200 V power supply.

The following models use single-phase 200 V power input.
SGDV-R70A, R90A, 1R6A, 2R8A, 5R5A

When using the SERVOPACK with single-phase, 200 V power input, set parameter Pn00B.2 to 1.

The SGDV-120AE1A008000 SERVOPACK has specifications for a single-phase, 200-V power supply, and so a single-phase, 200-V power supply can be used without changing the parameters.

(1) Parameter Setting

■ Single-phase Power Input Selection

Parameter		Meaning	When Enabled	Classification
Pn00B	n.□0□□	Enables use of three-phase power supply for three-phase SERVOPACK. [factory setting]	After restart	Setup
	n.□1□□	Enables use of single-phase power supply for three-phase SERVOPACK.		

WARNING

- If single-phase 200 V is input to a SGDV-R70A, -R90A, -1R6A, -2R8A, or -5R5A SERVOPACK with a single-phase power input without changing the setting of Pn00B.2 to 1 (single-phase power input supported), a main circuit cable open phase alarm (A.F10) will be detected.
- The SERVOPACK models, SGDV-R70A, -R90A, -1R6A, -2R8A, and -5R5A, support single-phase 200 V power input. If a single-phase 200 V is input to the SERVOPACK models that do not support single-phase power input, the main circuit cable open phase alarm (A.F10) will be detected.
- When using a single-phase 200 V power supply, the SGDV-R70A, -R90A, -1R6A, -2R8A, or -5R5A SERVOPACK may not be able to produce the same servomotor torque-speed characteristics as using a three-phase 200 V power input. Refer to the diagram of each motor torque-speed characteristics in *Σ -V Series Product Catalog* (KAEP S800000 42).

(2) Main Circuit Power Input

Connect a single-phase 200 V power supply of the following specifications to L1 and L2 terminals.

The specifications of the power supplies other than the main circuit power supply are the same as for three-phase power supply input.

Terminal Symbols	Name	Model SGDV-□□□A	Rating
L1, L2	Main circuit power input terminals	R70, R90, 1R6, 2R8, 5R5	Single-phase 200 V to 230 V $^{+10\%}_{-15\%}$, (50/60 Hz)
		120*2	Single-phase 220 V to 230 V $^{+10\%}_{-15\%}$, (50/60 Hz)
L3*1	—	R70, R90, 1R6, 2R8, 5R5	None

*1. Do not use L3 terminal.

*2. The official model number is SGDV-120AE1A008000.

(3) SERVOPACK Main Circuit Wire

Terminal Symbols	Name	Model SGD□V-□□□A					
		R70	R90	1R6	2R8	5R5	120*
L1, L2	Main circuit power input terminals	HIV1.25			HIV2.0		HIV3.5
L1C, L2C	Control power supply input terminals	HIV1.25					
U, V, W	Motor connection terminals	HIV1.25				HIV2.0	
B1/ ⊕, B2	External regenerative resistor connection terminals	HIV1.25					
⊕	Ground terminals	HIV2.0 or higher					

* The official model name is SGD□V-120AE1A008000.

(4) Wiring Example with Single-phase 200 V Power Supply Input

- SERVOPACK SGD□V-R70A, R90A, 1R6A, 2R8A, 5R5A, and 120AE1A008000 with Single-phase 200 V Input

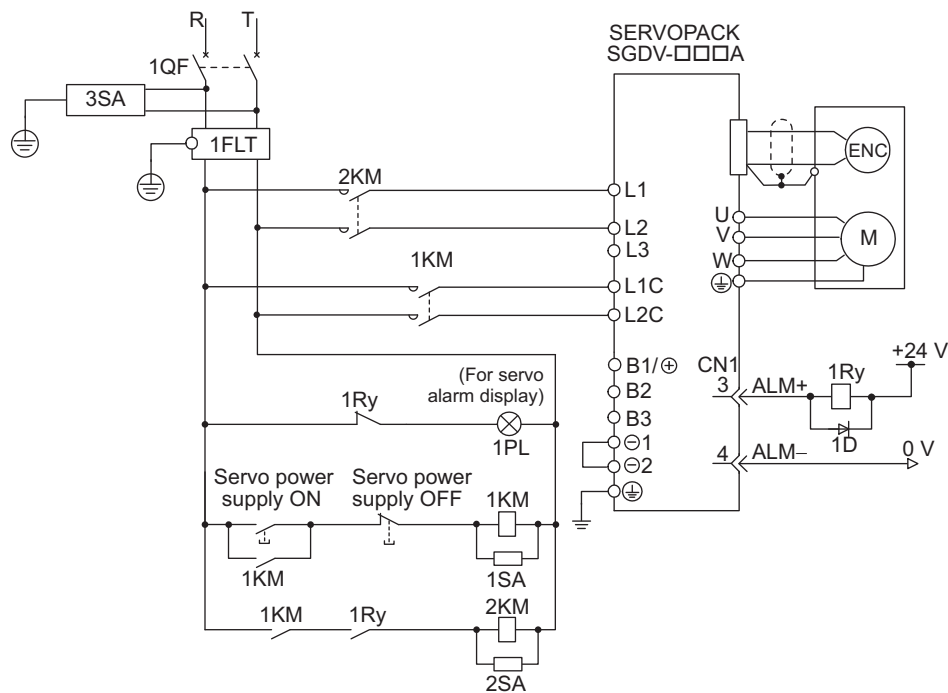

1QF: Molded-case circuit breaker
 1FLT: Noise filter
 1KM: Magnetic contactor (for control power supply)
 2KM: Magnetic contactor (for main power supply)
 1Ry: Relay

1PL: Indicator lamp
 1SA: Surge absorber
 2SA: Surge absorber
 3SA: Surge absorber
 1D: Flywheel diode

(5) Power Supply Capacities and Power Losses

The following table shows SERVOPACK's power supply capacities and power losses when using a single-phase 200 V power supply.

Main Power Supply	Maximum Applicable Servomotor Capacity [kW]	SERVOPACK Model SGD V-	Power Supply Capacity per SERVOPACK [kVA]	Output Current [Arms]	Main Circuit Power Loss [W]	Regenerative Resistor Power Loss [W]	Control Circuit Power Loss [W]	Total Power Loss [W]
Single-phase, 200 V	0.05	R70A	0.2	0.66	5.2	-	17	22.2
	0.1	R90A	0.3	0.91	7.4			24.4
	0.2	1R6A	0.7	1.6	13.7			30.7
	0.4	2R8A	1.2	2.8	24.9			41.9
	0.75	5R5A	1.9	5.5	52.7	8	77.7	
	1.5	120A*	4	11.6	68.2	10	22	100.2

* The official model name is SGD V-120AE1A008000.

Note 1. SGD V-R70A, R90A, 1R6A, and 2R8A SERVOPACKs do not have built-in regenerative resistors. If the regenerative energy exceeds the specified value, connect an external regenerative resistor.

2. Regenerative resistor power losses are allowable losses. Take the following action if the actual power losses exceeds the allowable power loss.

- Remove the wire connecting terminals B2 and B3 of the SERVOPACK main circuit terminals or remove the short bar (SGDV-5R5A, 120A).
- Install an external regenerative resistor between the external regenerative resistor connection terminals B1/ ⊕ and B2

3. External regenerative resistors are options.

(6) Molded-case Circuit Breaker and Fuse Capacities

The following table shows the molded-case circuit breaker and fuse capacities when using single-phase 200 V power supply.

Main Power Supply	Maximum Applicable Servomotor Capacity [kW]	SERVOPACK Model SGD V-	Power Supply Capacity per SERVOPACK [kVA]	Current Capacity		Inrush Current	
				Main Circuit [Arms]	Control Circuit [Arms]	Main Circuit [A0-p]	Control Circuit [A0-p]
Single-phase, 200 V	0.05	R70A	0.2	2	0.2	33	70
	0.1	R90A	0.3	2			
	0.2	1R6A	0.7	3			
	0.4	2R8A	1.2	5			
	0.75	5R5A	1.9	9			
	1.5	120A*	4	16	0.25	33	

* The official model name is SGD V-120AE1A008000.

Note 1. To comply with the low voltage directive, connect a fuse to the input side. Select the fuse for the input side from among models that are compliant with UL standards.

The table above also provides the net values of current capacity and inrush current. Select a fuse and a molded-case circuit breaker which meet the breaking characteristics shown below.

- Main circuit, control circuit: No breaking at three times the current values shown in the table for 5 s.
- Inrush current: No breaking at the current values shown in the table for 20 ms.

2. The following usage restrictions apply to the UL installation certification conditions for the SGD V-120AE1A008000 SERVOPACK.

Available rated current for molded-case circuit breaker: 40 A or less.

3.1.4 Using the SERVOPACK with a DC Power Input

(1) Parameter Settings

When using the SERVOPACK with a DC power input, set parameter Pn001.2 to 1.

Parameter	Meaning	When Enabled	Classification
Pn001	n.□0□□	After restart	Setup
	n.□1□□		

Observe the following precautions when using a DC power input.

 WARNING
<ul style="list-style-type: none"> • Either AC or DC power can be input to the 200 V, 400 V SERVOPACKs. Always set Pn001.2 to 1 to specify a DC power input before inputting DC power. Only AC power can be input to the 100 V SERVOPACKs. If DC power is input without changing the parameter setting, the SERVOPACK's internal elements will burn and may cause fire or equipment damage. • With a DC power input, time is required to discharge electricity after the main power supply is turned OFF. A high residual voltage may remain in the SERVOPACK after the power supply is turned OFF. Be careful not to get an electric shock. • Install fuses on the wires if DC power is used. • Servomotor returns a regenerated energy to the power supply. The SERVOPACK that can use a DC power supply is not capable of processing the regenerated energy. Provide measures to process the regenerated energy on the power supply. • With a DC power input, connect an external inrush current limit circuit. Failure to observe this caution may result in damage to the product.

(2) DC Power Supply Input Terminals for the Main and Control Circuits

- Three-phase, 200-V SGD□V-□□□A (□□□ = R70, R90, 1R6, 2R8, 3R8, 5R5, 7R6, 120, 180, 200, 330)

Terminal Symbols	Name	Specification
B1/ ⊕	Main circuit plus terminal	270 to 320 VDC
⊖ 2	Main circuit minus terminal	0 VDC
L1C, L2C	Control power supply input terminal	200 to 230 VAC

- Three-phase, 200-V SGD□V-□□□A (□□□ = 470, 550, 590, 780)

Terminal Symbols	Name	Specification
B1/ ⊕	Main circuit plus terminal	270 to 320 VDC
⊖	Main circuit minus terminal	0 VDC
L1C, L2C	Control power supply input terminal	200 to 230 VAC

- Three-phase, 400-V SGD□V-□□□D (□□□ = 1R9, 3R5, 5R4, 8R4, 120, 170, 210, 260, 280, 370)

Terminal Symbols	Name	Specification
B1/ ⊕	Main circuit plus terminal	513 to 648 VDC
⊖ 2	Main circuit minus terminal	0 VDC
24 V, 0 V	Control power supply input terminal	24 VDC (±15%)

(3) Wiring Examples with DC Power Supply Input

■ SERVOPACK SGDV-□□□A with 200-V Power Supply Input

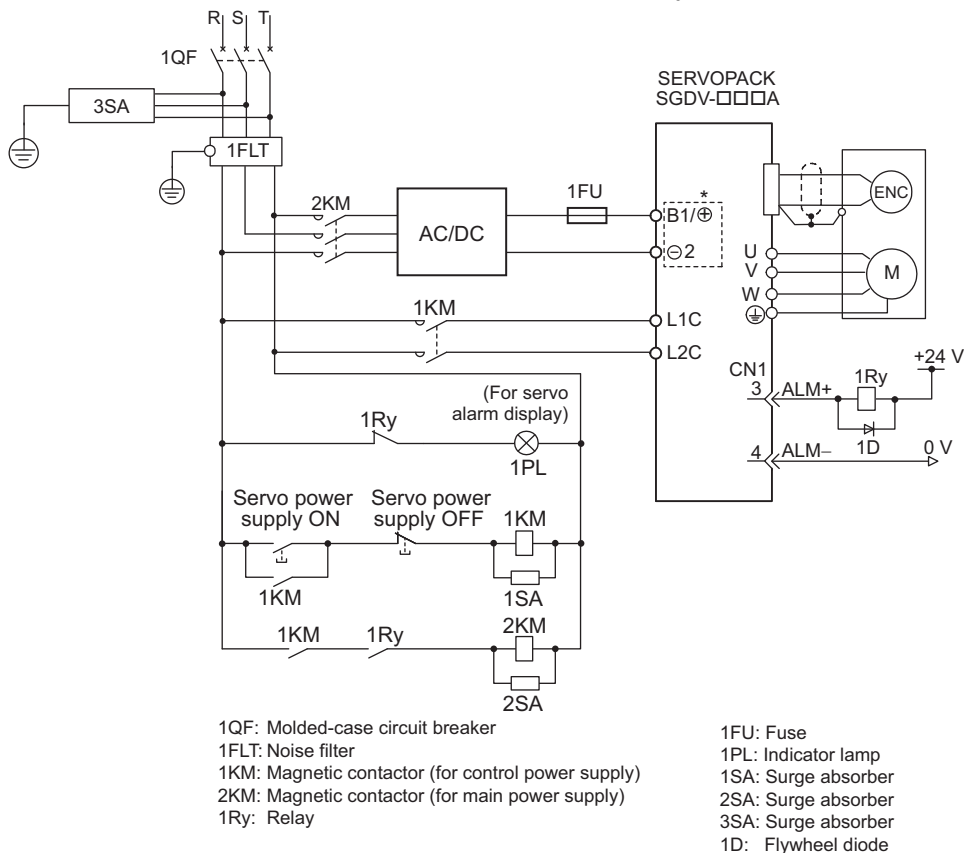

* Terminal names differ from model of SERVOPACK. Refer to (1) Parameter Settings.

■ SERVOPACK SGDV-□□□D with 400-V Power Supply Input

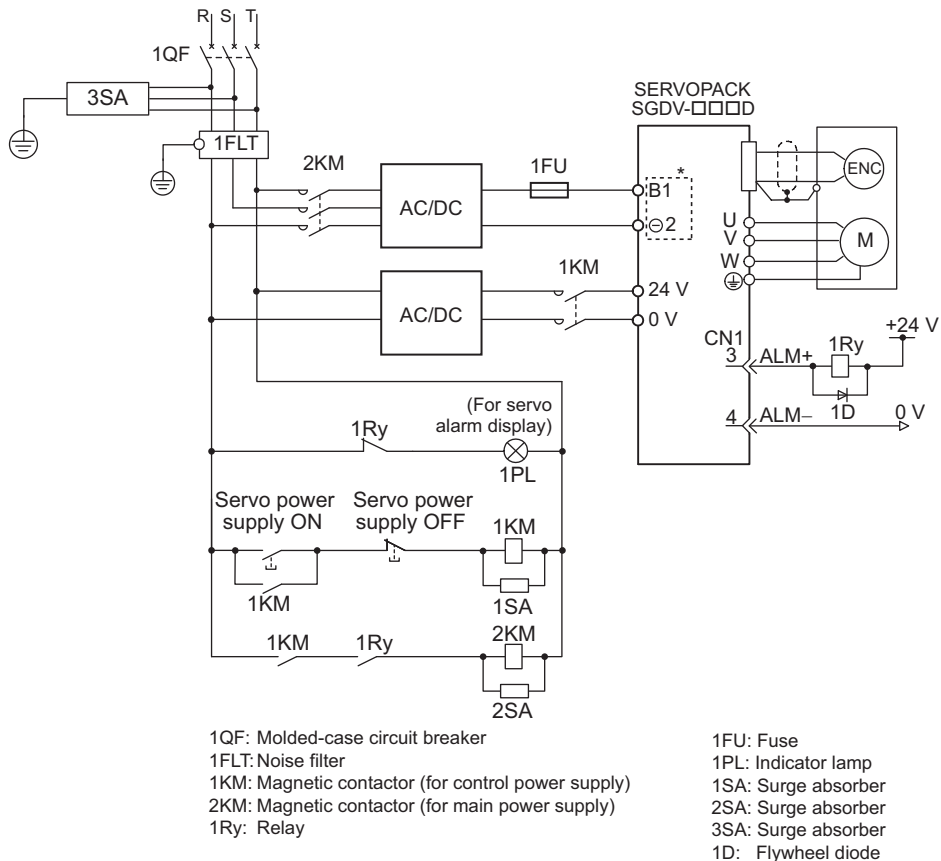

* Terminal names differ from model of SERVOPACK. Refer to (1) Parameter Settings.

3.1.5 Using More Than One SERVOPACK

This section shows an example of the wiring when more than one SERVOPACK is used and the precautions.

(1) Wiring Example

Connect the alarm output (ALM) terminals for the three SERVOPACKs in series to enable alarm detection relay 1Ry to operate.

When the alarm occurs, the ALM output signal transistor is turned OFF.

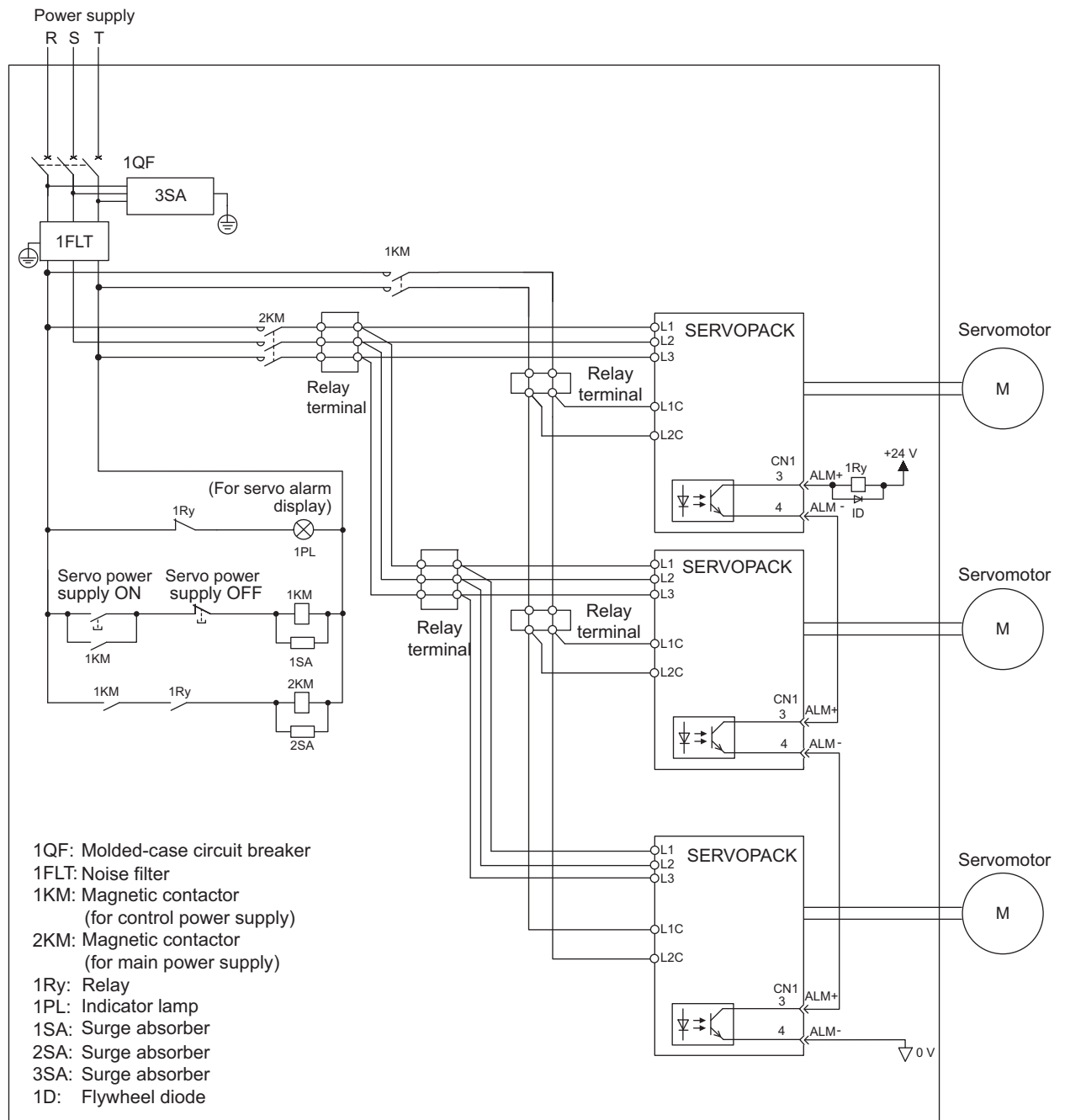

(2) Precautions

Multiple servos can share a single molded-case circuit breaker (1QF) and a noise filter. Always select a 1QF and a noise filter that has enough capacity for the total power capacity (load conditions) of those servos.

3.1.6 General Precautions for Wiring

 IMPORTANT	<p>Use a molded-case circuit breaker (1QF) or fuse to protect the main circuit.</p> <ul style="list-style-type: none"> The SERVOPACK connects directly to a commercial power supply; it is not isolated through a transformer or other device. <p>Always use a molded-case circuit breaker (1QF) or fuse to protect the servo system from accidents involving different power system voltages or other accidents.</p> <p>Install a ground fault detector.</p> <ul style="list-style-type: none"> The SERVOPACK does not have a built-in protective circuit for grounding. To configure a safer system, install a ground fault detector against overloads and short-circuiting, or install a ground fault detector combined with a molded-case circuit breaker. <p>Do not turn power ON and OFF frequently.</p> <ul style="list-style-type: none"> The power supply in the SERVOPACK contains a capacitor, which causes a high charging current to flow when power is turned ON. Frequently turning power ON and OFF will cause the main circuit elements in the SERVOPACK to deteriorate.
---	--

To ensure safe, stable application of the servo system, observe the following precautions when wiring.

Use the connecting cables specified in the *Σ-V Series Product Catalog* (KAEP S800000 42). Design and arrange the system so that each cable will be as short as possible.

- Use shielded twisted-pair wires or shielded multi-core twisted-pair wires for signal cables and encoder cables.
- The maximum wiring length is 3 m for signal cables, 50 m for encoder cables and servomotor main circuit cables, and 10 m for control power supply cables for SERVOPACKs with a power supply of 400 V(+24 V, 0 V).

Observe the following precautions when wiring the ground.

- Use a cable as thick as possible (at least 2.0 mm²).
- Grounding to a resistance of 100 Ω or less for SERVOPACKs with a power supply of 100 V or 200 V and 10 Ω or less for SERVOPACKs with a power supply of 400 V is recommended.
- Be sure to ground at only one point.
- Ground the servomotor directly if the servomotor is insulated from the machine.

The signal cable conductors are as thin as 0.2 mm² or 0.3 mm². Do not impose excessive bending force or tension.

3.2 I/O Signal Connections

This section describes the names and functions of I/O signals (CN1). Also, connection examples by control method are shown.

3.2.1 I/O Signal (CN1) Names and Functions



IMPORTANT

Regarding the allocation and use of I/O signals, they differ in accordance with the connected option module. For details, refer to the manual for the command option module that is connected.

The following table shows the names and functions of I/O signals (CN1).

(1) Input Signals

Signal	Pin No.	Name	Function	Reference Section
/SI3	9	Command option module input 3	Connects the external input signal used in the command option module.	–
P-OT	7	Forward run prohibited	Overtravel prohibited: Stops servomotor when movable part travels beyond the allowable range of motion.	4.2.2
N-OT	8	Reverse run prohibited		
/SI4	10	Command option module input 4	Connects the external input signal used in the command option module.	–
/SI5	11	Command option module input 5		
/SI6	12	Command option module input 6		
+24VIN	6	Control power supply input for sequence signal	Control power supply input for sequence signals. Allowable voltage fluctuation range: 11 to 25 V Note: The +24-V power supply is not included.	3.4.1
BAT(+)	14	Battery (+) input	Connecting pin for the absolute encoder backup battery.	–
BAT(-)	15	Battery (-) input		
/SI0	13	General-purpose input	Connects the external input signal used in the command option module.	–

- Note 1. The functions allocated to /SI3, P-OT, N-OT, /SI4, /SI5, and /SI6 input signals can be changed by using the parameters. Refer to 3.3.1 *Input Signal Allocations*.
2. If the Forward run prohibited/Reverse run prohibited function is used, the software can be used to stop the SERVOPACK. If the application does not satisfy the safety requirements, add an external circuit for safety reasons as required.

(2) Output Signals

Signal	Pin No.	Name	Function	Reference Section
ALM+	3	Servo alarm output	Turns OFF when an error is detected.	-
ALM-	4			
/BK+ (/SO1+)	1	Brake output	Controls the brake. The brake is released when the signal turns ON. Allocation can be changed to general-purpose output signals (/SO1+, /SO1-).	4.2.3
/BK- (/SO1-)	2			
/SO2+	23	General-purpose output	General-purpose output signals Note: Set the parameters to allocate functions.	-
/SO2-	24			
/SO3+	25			
/SO3-	26			
FG	Connector shell	Frame ground	Connected to frame ground if the shield wire of the I/O signal cable is connected to the connector shell.	-

Note: For more information on the allocation of /SO1, /SO2, and /SO3, refer to 3.3.2 *Output Signal Allocation*.

3.2.2 Safety Function Signal (CN8) Names and Functions

The following table shows the terminal layout of safety function signals (CN8).

Signal	Pin No.	Name	Function
/HWBB1-	3	Hard wire base block input 1	Hard wire base block input Base block (motor current off) when OFF
/HWBB1+	4		
/HWBB2-	5	Hard wire base block input 2	
/HWBB2+	6		
EDM1-	7	Monitored circuit status output 1	ON when the /HWBB1 and the /HWBB2 signals are input and the SERVOPACK enters a base block state.
EDM1+	8		
-	1*	-	-
-	2*	-	-

* Do not use pins 1 and 2. They are connected to the internal circuits.

3.2.3 Example of I/O Signal Connections

The following diagram shows a typical connection example.

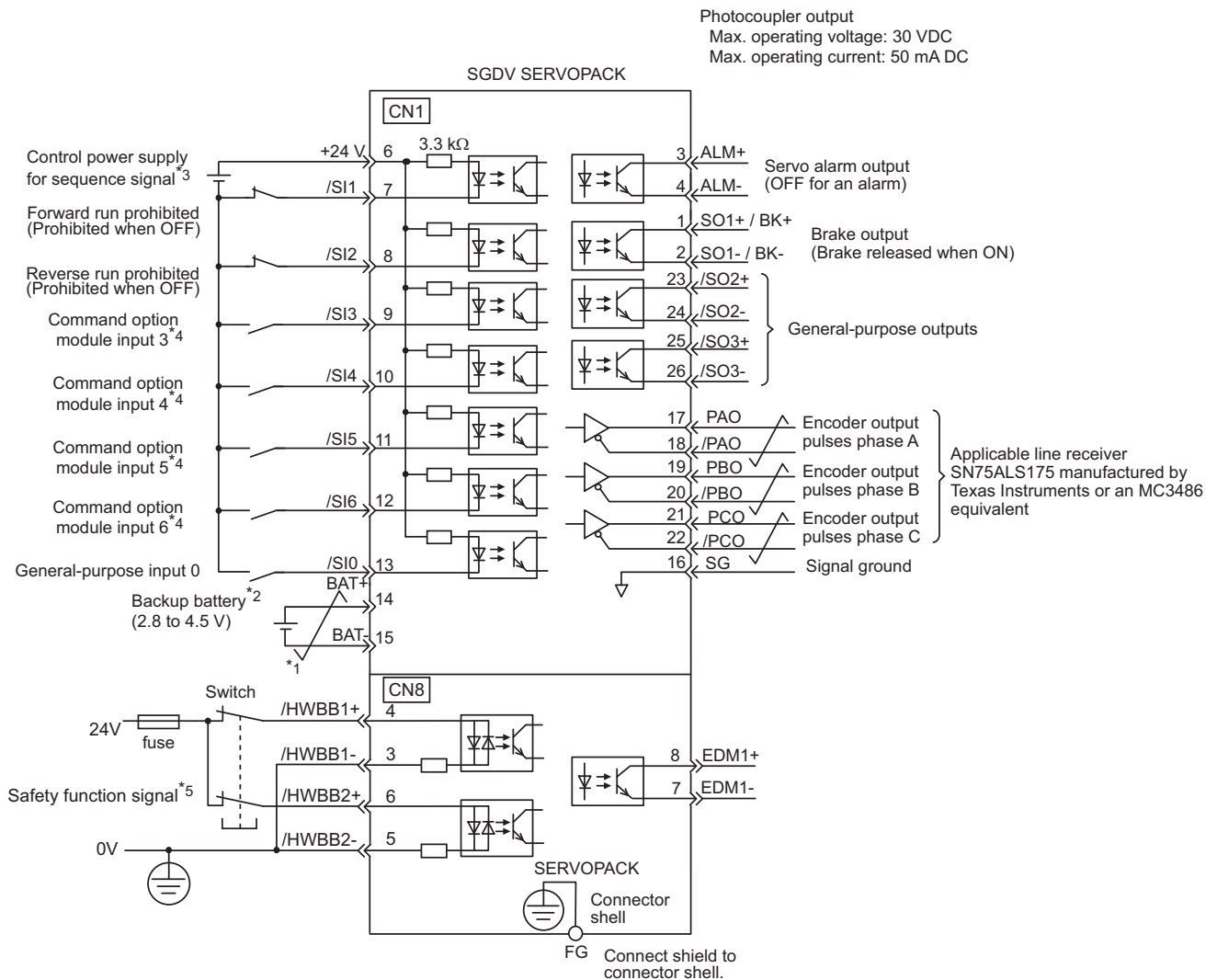

- *1. represents twisted-pair wires.
- *2. Connect when using an absolute encoder. When the encoder cable for the battery case is connected, do not connect a backup battery.
- *3. The 24 VDC power supply is not included. Use a power supply with double insulation or reinforced insulation.
- *4. For details, refer to the manual of the connected command option module.
- *5. To turn the servomotor power ON, a safety device must be connected and the wiring to activate the safety function must be done. When not using the safety function, use the SERVOPACK with the plug (JZSP-CVH05-E, provided as an accessory) inserted into the CN8.

Note: The functions allocated to the input signals /SI3, P-OT, N-OT, /SI0, /SI4, /SI5, and /SI6 and the output signals /SO1, /SO2, and /SO3 can be changed by using the parameters. Refer to 3.3.1 *Input Signal Allocations* and 3.3.2 *Output Signal Allocation*.

3.3 I/O Signal Allocations

This section describes the I/O signal allocations.

3.3.1 Input Signal Allocations



IMPORTANT

- Inverting the polarity of the Forward Run Prohibited, and Reverse Run Prohibited signals will prevent the holding brake from working in case of their signal line disconnections. If such setting is absolutely necessary, confirm the operation and observe safety precautions.
- If two or more signals are allocated to the same input circuit, a signal is output with or logic circuit input signal level is valid for all allocated signals.

Input signals are allocated as shown in the following table.

Refer to the *Interpreting the Input Signal Allocation Tables* and change the allocations accordingly.

<Interpreting the Input Signal Allocation Tables>

Level at which input signal allocations are valid.

The parameter set values to be used are shown. Signals are allocated to CN1 pins according to the selected set values. Values in cells in bold lines are the factory settings.

Input Signal Names and Parameters	Validity Level	Input Signal	CN1 Pin Numbers							Connection Not Required (SERVOPACK judges the connection)	
			13	7	8	9	10	11	12	Always ON	Always OFF
Forward Run Prohibited Pn50A.3	H	P-OT	0	1	2	3	4	5	6	7	8
	L	/P-OT	9	A	B	C	D	E	F	7	8

If always ON (7) or always OFF (8) is set, signals will be processed in the SERVOPACK, which will eliminate the need for wiring changes.

Input Signal Names and Parameters	Validity Level	Input Signal	CN1 Pin Numbers							Connection Not Required (SERVOPACK judges the connection)	
			13	7	8	9	10	11	12	Always ON	Always OFF
Forward Run Prohibited Pn50A.3	H	P-OT	0	1	2	3	4	5	6	7	8
	L	/P-OT	9	A	B	C	D	E	F		
Reverse Run Prohibited Pn50B.0	H	N-OT	0	1	2	3	4	5	6	7	8
	L	/N-OT	0	A	B	C	D	E	F		
Forward External Torque Limit Pn50B.2	L	/P-CL	0	1	2	3	4	5	6	7	8
	H	P-CL	9	A	B	C	D	E	F		
Reserve External Torque Limit Pn50B.3	L	/N-CL	0	1	2	3	4	5	6	7	8
	H	N-CL	9	A	B	C	D	E	F		
Command Option Module Input 3 ^{*1} Pn511.0	L	/SI3	0	1	2	3	4	5	6	7	8
	H	SI3	9	A	B	C	D	E	F		
Command Option Module Input 4 ^{*1} Pn511.1	L	/SI4	*2	*2	*2	*2	4	5	6	7	8
	H	SI4	*2	*2	*2	*2	D	E	F		
Command Option Module Input 5 ^{*1} Pn511.2	L	/SI5	*2	*2	*2	*2	4	5	6	7	8
	H	SI5	*2	*2	*2	*2	D	E	F		
Command Option Module Input 6 ^{*1} Pn511.3	L	/SI6	*2	*2	*2	*2	4	5	6	7	8
	H	SI6	*2	*2	*2	*2	D	E	F		

*1. For details, refer to the manual of the connected command option module.

*2. Allocation is not possible.

3.3.2 Output Signal Allocation



IMPORTANT

- The signals not detected are considered as "Invalid." For example, Positioning Completion (/COIN) signal in speed control is "Invalid."
- Inverting the polarity of the brake signal (/BK), i.e. positive logic, will prevent the holding brake from working in case of its signal line disconnection. If this setting is absolutely necessary, check the operation and confirm that there are no safety problems.
- When two or more signals are allocated to the same output circuit, a signal is output with OR logic circuit.

Output signals are allocated as shown in the following table.

Refer to the *Interpreting the Output Signal Allocation Tables* and change the allocations accordingly.

<Interpreting the Output Signal Allocation Tables>

The parameter set values to be used are shown. Signals are allocated to CN1 pins according to the selected set values. Values in cells in bold lines are the factory settings.

Output Signal Names and Parameters	Output Signal	CN1 Pin Numbers			Invalid (not use)
		1/(2)	23/(24)	25/(26)	
Positioning Completion Pn50E.0	/COIN	1	2	3	0

Output Signal Names and Parameters	Output Signal	CN1 Pin Numbers			Invalid (not use)
		1/ (2)	23/ (24)	25/ (26)	
Positioning Completion Pn50E.0	/COIN	1	2	3	0
Speed Coincidence Detection Pn50E.1	/V-CMP	1	2	3	0
Rotation Detection Pn50E.2	/TGON	1	2	3	0
Servo Ready Pn50E.3	/S-RDY	1	2	3	0
Torque Limit Detection Pn50F.0	/CLT	1	2	3	0
Speed Limit Detection Pn50F.1	/VLT	1	2	3	0
Brake Pn50F.2	/BK	1	2	3	0
Warning Pn50F.3	/WARN	1	2	3	0
Near Pn510.0	/NEAR	1	2	3	0
Output signal polarity inversion Pn512.0=1	Polarity inversion of CN1-1(2)			0 (Not invert at factory setting)	
Output signal polarity inversion Pn512.1=1	Polarity inversion of CN1-23(24)				
Output signal polarity inversion Pn512.2=1	Polarity inversion of CN1-25(26)				

3.4 Connection to Host Controller

This section shows examples of SERVOPACK I/O signal connection to the host controller.

3.4.1 Sequence Input Circuits

(1) Photocoupler Input Circuit

CN1 connector terminals 6 to 13 are explained below.

The sequence input circuit interface connects through a relay or open-collector transistor circuit. Select a low-current relay if a relay is used. Otherwise, a faulty contact will result.

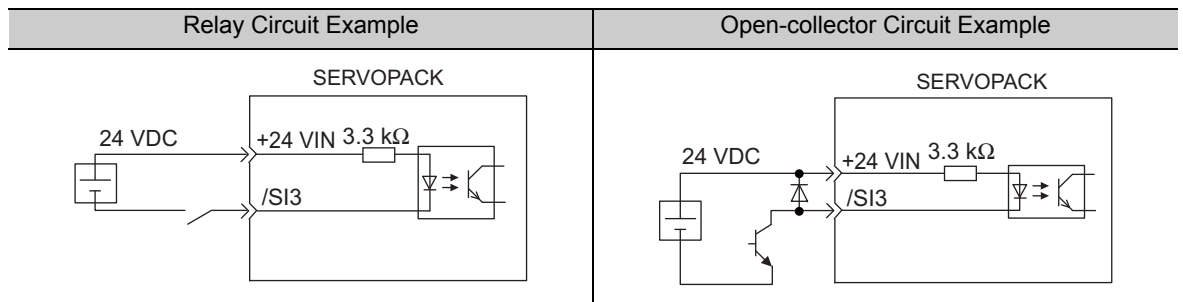

Note: The 24 VDC external power supply capacity must be 50 mA minimum.

The SERVOPACK's I/O circuit uses bidirectional photocoupler. Select either the sink circuit or the source circuit according to the specifications required for each machine.

- Note:
- The connection example in section 3.2.3 shows the connection using the sink circuit.
 - The polarity for turning the input signal ON or OFF differs between the sink circuit and the source circuit.

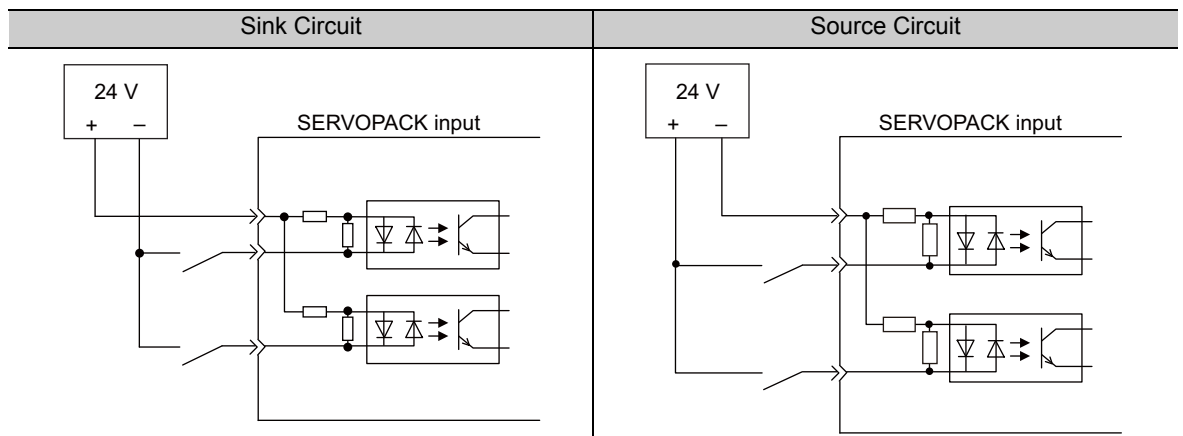

Input Signal Polarities				Input Signal Polarities			
Signal	Level	Voltage Level	Contact	Signal	Level	Voltage Level	Contact
ON	Low (L) level	0 V	Close	ON	High (H) level	24 V	Close
OFF	High (H) level	24 V	Open	OFF	Low (L) level	0 V	Open

(2) Safety Input Circuit

As for wiring input signals for safety function, input signals make common 0 V. It is necessary to make an input signal redundant.

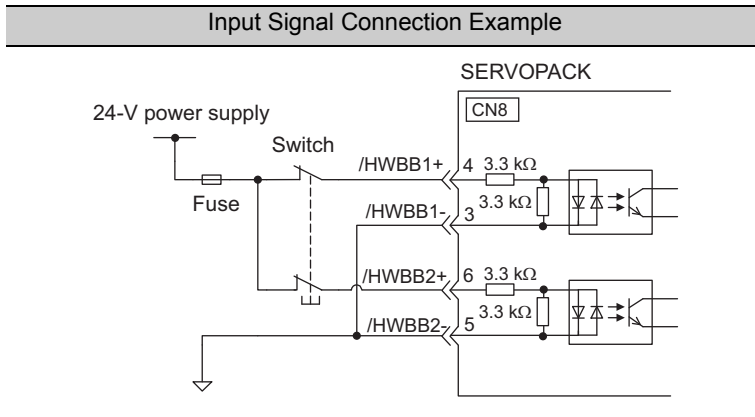

3.4.2 Sequence Output Circuits

The following diagrams show examples of how output circuits can be connected the SERVOPACK.

 IMPORTANT	<p>Incorrect wiring or incorrect voltage application to the output circuit may cause short-circuit.</p> <p>If a short-circuit occurs as a result of any of these causes, the holding brake will not work. This could damage the machine or cause an accident resulting in death or injury.</p>
---	--

(1) Photocoupler Output Circuit

Photocoupler output circuits are used for servo alarm (ALM), servo ready (/S-RDY), and other sequence output signal circuits. Connect a photocoupler output circuit through a relay or line receiver circuit.

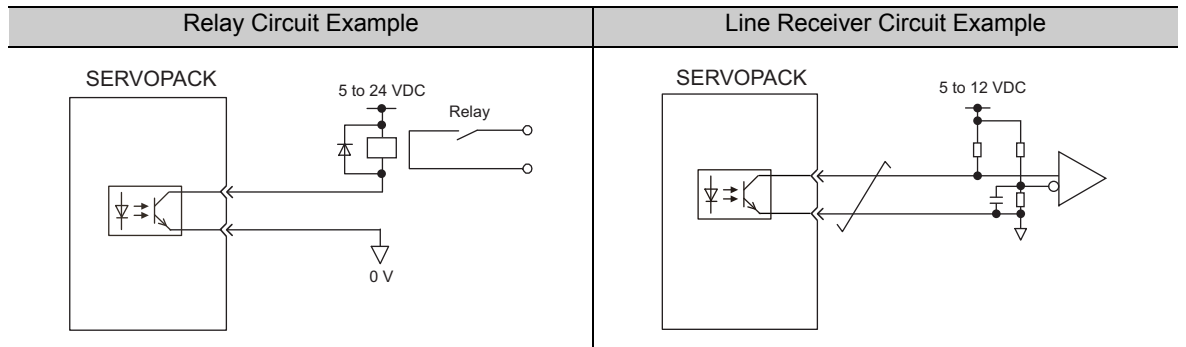

Note: The maximum allowable voltage and current capacities for photocoupler output circuits are as follows.

- Voltage: 30 VDC
- Current: 5 to 50 mA DC

(2) Line Driver Output Circuit

CN1 connector terminals, 17-18 (phase-A signal), 19-20 (phase-B signal), and 21-22 (phase-C signal) are explained below.

Encoder serial data converted to two-phase (phases A and B) pulse output signals (PAO, /PAO, PBO, /PBO) and origin pulse signals (PCO, /PCO) are output via line-driver output circuits. Connect the line-driver output circuit through a line receiver circuit at the host controller.

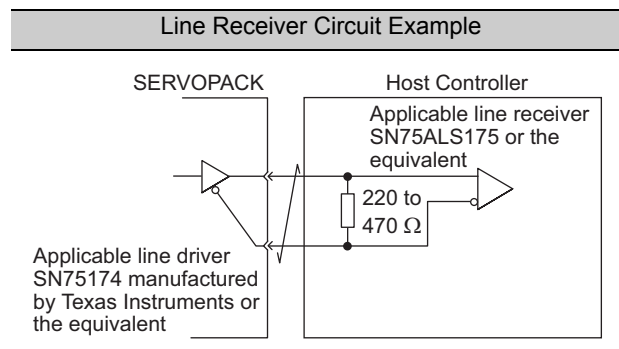

(3) Safety Output Circuit

External device monitor (EDM1), an output signal of safety function, is explained below.

■ Connection Example

The following figure shows a connection example for the EDM1 output signal.

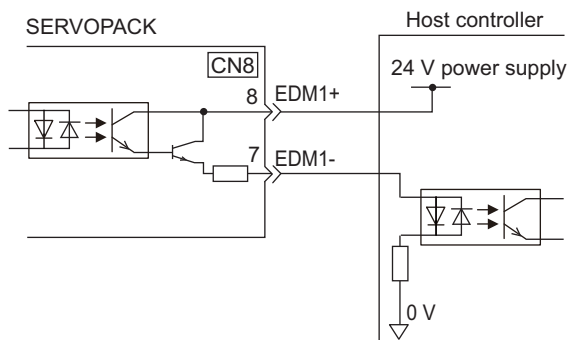

■ Specifications

Type	Signal Name	Pin No.	Input Status	Meaning
Output	EDM1	CN8-8 CN8-7	ON	The /HWBB1 signal and /HWBB2 signal are both operating normally.
			OFF	Both the /HWBB1 signal and /HWBB2 signal are not operating normally or either of the two is not operating normally.

Electrical characteristics of EDM1 signal are as follows.

Items	Characteristic	Remarks
Maximum Allowable Voltage	30 VDC	—
Maximum Current	50 mADC	—
Maximum Voltage Drop at ON	1.0 V	Voltage between EDM1+ to EDM1- at current is 50 mA.
Maximum Delay Time	20 ms	Time from change of /HWBB1, /HWBB2 to change of EDM1

3.5 Wiring Communications Using Command Option Modules

The following diagram shows an example of connections between a host controller and a SERVOPACK using communications with command option modules.

Connect the connector of the communications cable to the command option module.

For details, refer to the manual of the connected command option module.

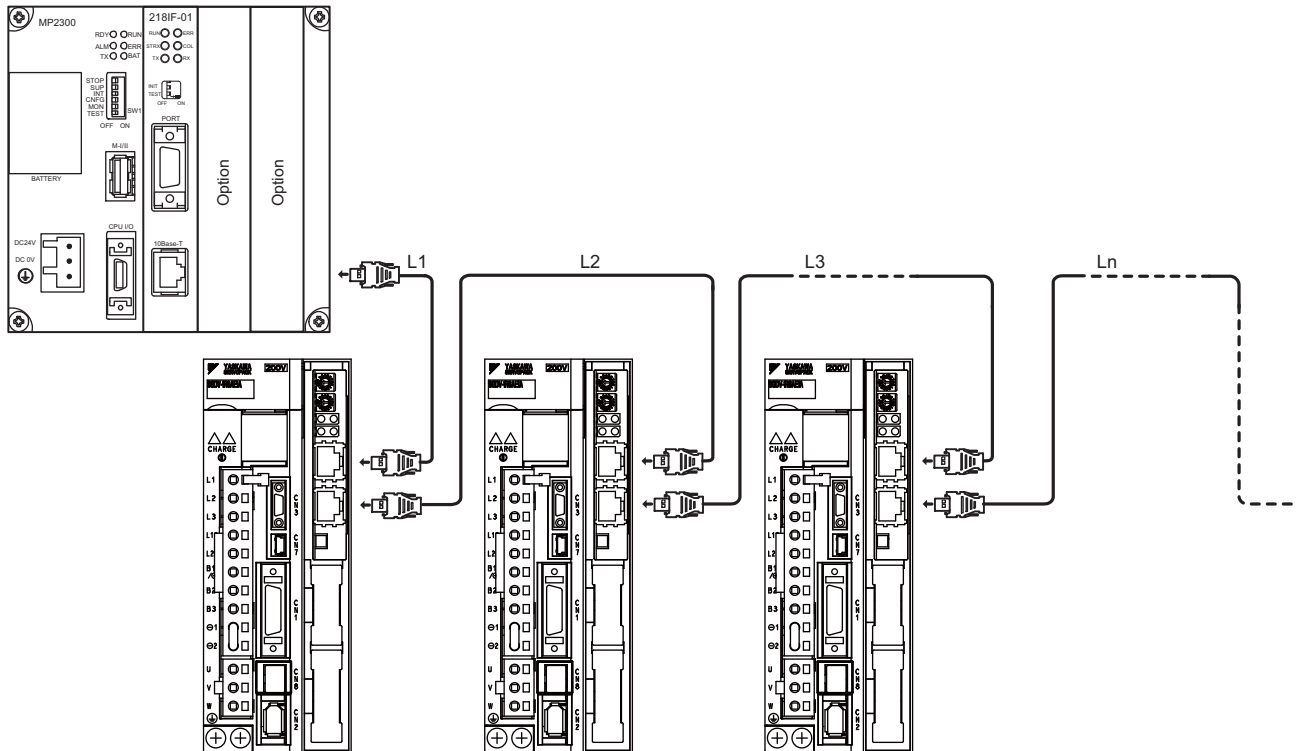

3.6 Encoder Connections

This section shows the names and functions of the encoder signals (CN2) and describes examples of encoder connection.

3.6.1 Encoder Signal (CN2) Names and Functions

The following table shows the names and functions of the encoder signals (CN2).

Signal	Pin No.	Function
PG 5 V	1	Encoder power supply +5 V
PG 0 V	2	Encoder power supply 0 V
BAT (+) *	3	Battery (+)
BAT (-) *	4	Battery (-)
PS	5	Serial data (+)
/PS	6	Serial data (-)
Shell	Shell	-

* If an incremental encoder is used, these signals do not need to be connected.

3.6.2 Examples of Encoder Connection

The following diagrams show examples of connecting an encoder, SERVOPACK, and host controller.

(1) Incremental Encoder

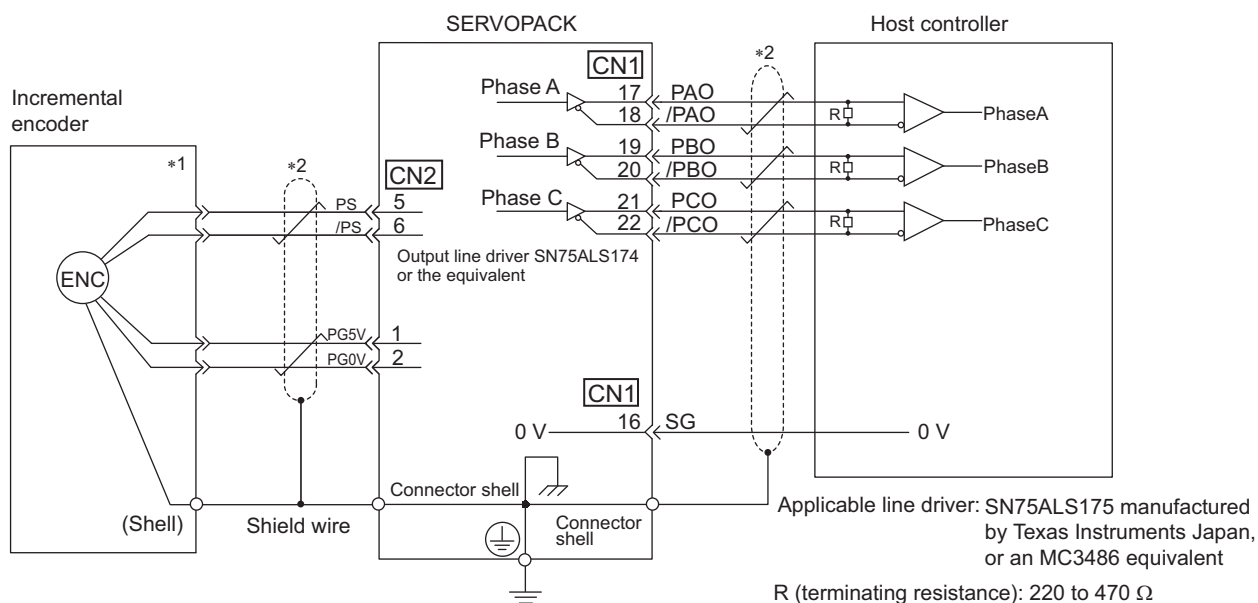

*1. The pin numbers for the connector wiring of the incremental encoder depend on the servomotor.

*2.  : represents twisted-pair wires.

(2) Absolute Encoder

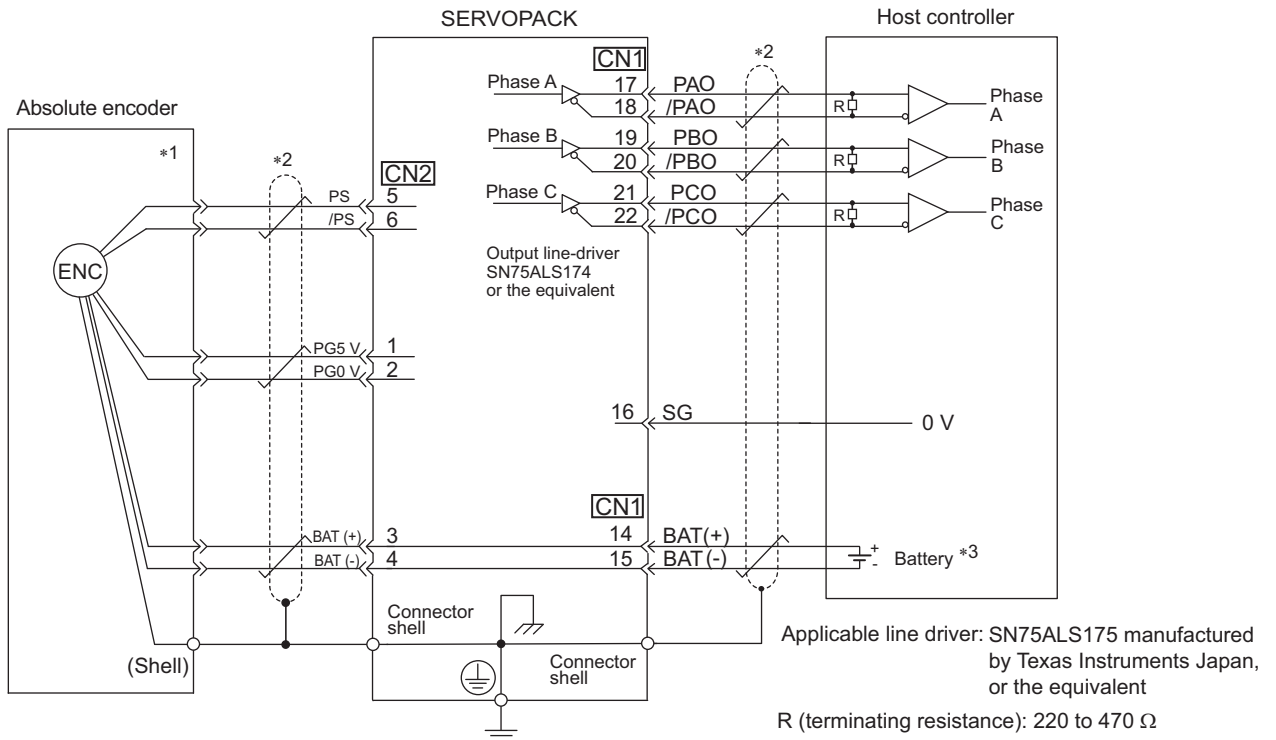

- *1. The pin numbers for the connector wiring of the absolute encoder depend on the servomotor.
- *2.  : represents twisted-pair wires.
- *3. When using an absolute encoder, install an encoder cable with a JUSP-BA01-E Battery Case or install a battery on the host controller to supply power.

3.7 Regenerative Resistors Connections

If the ability to absorb regenerative energy is insufficient, connect an external regenerative resistor in the following manner and set the regenerative resistor capacity in Pn600. As for precautions on selecting a regenerative resistor and its specifications, refer to *Σ -V series Product Catalog* (KAEP S800000 42).

WARNING

- Be sure to connect the regenerative resistor correctly.
Failure to observe this warning may result in fire or damage to the product.

3.7.1 Connecting Regenerative Resistors

The following instructions show how to connect the regenerative resistors and SERVOPACKs.

(1) SERVOPACKs: Model SGD V-R70F, R90F, 2R1F, 2R8F, R70A, R90A, 1R6A, 2R8A

Install an external regenerative resistor between the B1/⊕ and B2 terminals. Make the settings for the regenerative resistor after it is connected. For information setting the regenerative resistor, refer to 3.7.2 *Setting Regenerative Resistor Capacity*.

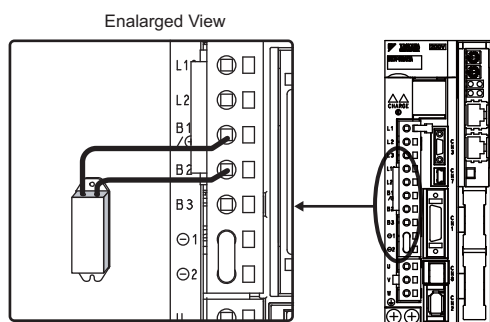

(2) SERVOPACKs: Model SGD V-3R8A, 5R5A, 7R6A, 120A, 180A, 200A, 330A, 1R9D, 3R5D, 5R4D, 8R4D, 120D, 170D

Disconnect the wiring between the SERVOPACK's B2 and B3 terminals and connect an external regenerative resistor between the B1/⊕ and B2 terminals. Make the settings for the regenerative resistor after it is connected. For information setting the regenerative resistor, refer to 3.7.2 *Setting Regenerative Resistor Capacity*.

Note: Be sure to take out the lead wire between the B2 and B3 terminals.

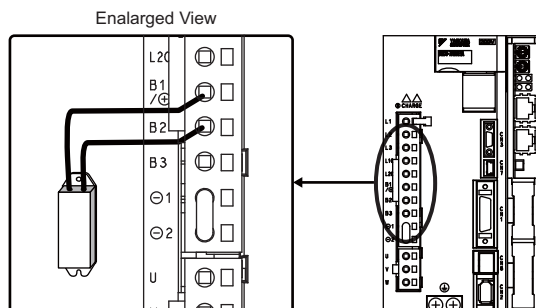

(3) SERVOPACKs: Model SGDV-470A, 550A, 590A, 780A, 210D, 260D, 280D, 370D

No built-in regenerative resistor is provided, so an external regenerative resistor unit is required. The regenerative resistor units are as follows:

Main Circuit Power Supply	SERVOPACK Model SGDV-	Applicable Regenerative Resistor Unit	Resistance (Ω)	Specifications
Three-phase 200 V	470A	JUSP-RA04-E	6.25	25 Ω (220 W); 4 resistors in parallel
	550A, 590A, 780A	JUSP-RA05-E	3.13	25 Ω (220 W); 8 resistors in parallel
Three-phase 400 V	210D, 260D	JUSP-RA18-E	18	18 Ω (220 W); 2 resistors in series with 2 in parallel.
	280D, 370D	JUSP-RA19-E	14.25	28.5 Ω (220 W); 2 resistors in series with 4 in parallel.

Connect a regenerative resistor unit between the B1 and B2 terminals.

When using a regenerative resistor unit, use the factory setting for Pn600. If a non-Yaskawa regenerative resistor is used, make the setting for Pn600.

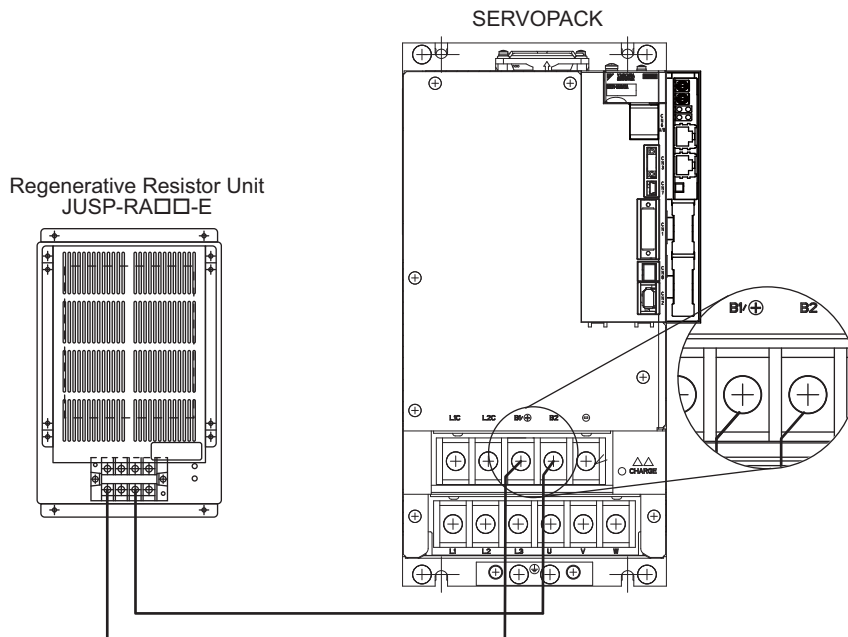

3.7.2 Setting Regenerative Resistor Capacity

When an external regenerative resistor is connected, make sure to set the regenerative resistor capacity using the parameter Pn600.

 WARNING	
<ul style="list-style-type: none"> If parameter Pn600 is set to 0 while an external regenerative resistor is connected, the generative overload alarm (A.320) may not be detected. If the generative overload alarm (A.320) is not detected correctly, the external regenerative resistor may be damaged and an injury or fire may result. 	

Pn600	Regenerative Resistor Capacity				Speed	Position	Torque	Classification
	Setting Range	Unit	Factory Setting	When Enabled				
	0 to SERVOPACK capacity	10 W	0	Immediately				

Be sure to set this parameter when installing an external regenerative resistor to the SERVOPACK.

When set to the factory setting of “0,” the SERVOPACK’s built-in resistor has been used.

Set the regenerative resistor capacity within tolerance value. When the set value is improper, alarm A.320 is detected.

The set value differs depending on the cooling method of external regenerative resistor:

- For natural convection cooling method: Set the value maximum 20% of the actually installed regenerative resistor capacity (W).
- For forced convection cooling method: Set the value maximum 50% of the actually installed regenerative resistor capacity (W).

Example: Set 20 W (100 W × 20%) for the 100 W external regenerative resistor with natural convection cooling method:

$$Pn600 = 2 \text{ (units: 10 W)}$$

 IMPORTANT	<ol style="list-style-type: none"> When the external regenerative resistors for power are used at the rated load ratio, the resistor temperature increases to between 200 °C and 300 °C. The resistors must be used at or below the rated values. Check with the manufacturer for the resistor’s load characteristics. For safety, use the external resistors with thermostats.
---	---

3.8 Noise Control and Measures for Harmonic Suppression

This section describes the wiring for noise control and the DC reactor for harmonic suppression.

3.8.1 Wiring for Noise Control



IMPORTANT

- Because the SERVOPACK is designed as an industrial device, it provides no mechanism to prevent noise interference.
- The SERVOPACK uses high-speed switching elements in the main circuit. Therefore peripheral devices may receive switching noise. If the equipment is to be used near private houses or if radio interference is a problem, take countermeasures against noise.
- Refer to *2.4 EMC Installation Conditions* in the Σ -V Series User's Manual Setup Rotational Motor (SIEP S800000 43) if installation conditions of the EMC directive must be satisfied.

The SERVOPACK uses microprocessors. Therefore it may receive switching noise from peripheral devices.

To prevent the noise from the SERVOPACK or the peripheral devices from causing a malfunction of any one of these devices, take the following precautions against noise as required.

- Position the input reference device and noise filter as close to the SERVOPACK as possible.
- Always install a surge absorber in the relay, solenoid and electromagnetic contactor coils.
- Do not bundle or run the main circuit cables together with the I/O signal cables in the same duct. Keep the main circuit cables separated from the I/O signal cables with a gap of at least 30 cm.
- Do not share the power supply with an electric welder or electrical discharge machine. When the SERVOPACK is placed near a high-frequency generator, install a noise filter on the input side of the main circuit power supply cables and control power supply cables. As for the wiring of noise filter, refer to *(1) Noise Filter*.
- Take the grounding measures correctly. As for the grounding, refer to *(2) Correct Grounding*.

(1) Noise Filter

The SERVOPACK has a built-in microprocessor (CPU), so protect it from external noise as much as possible by installing a noise filter in the appropriate place.

The following is an example of wiring for noise control.

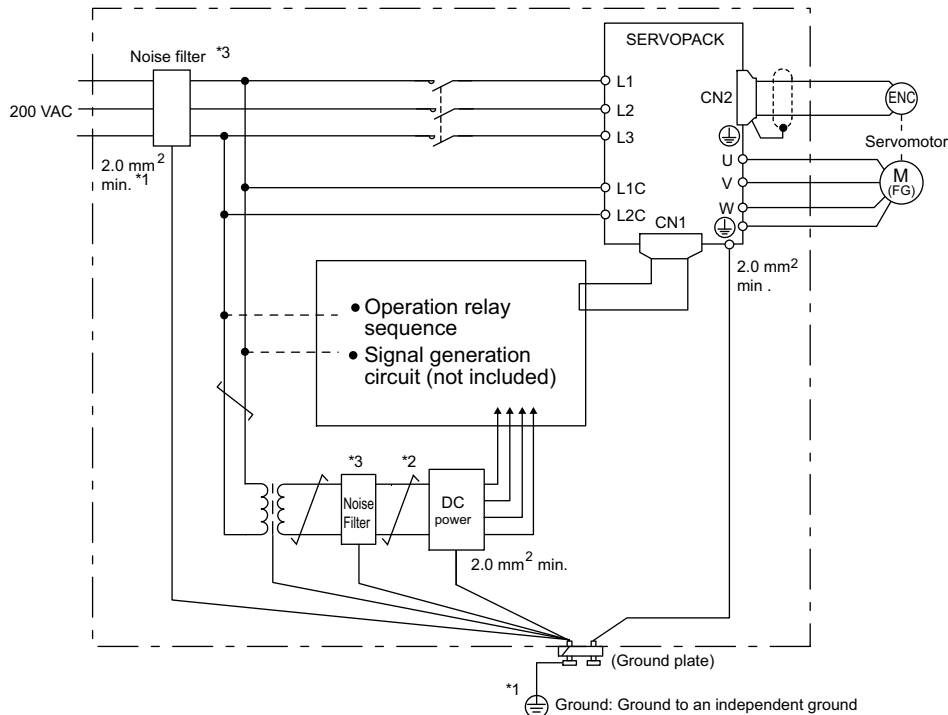

*1. For ground wires connected to the ground plate, use a thick wire with a thickness of at least 2.0 mm² (preferably, plain stitch cooper wire).

*2.  should be twisted-pair wires.

*3. When using a noise filter, follow the precautions in 3.8.2 *Precautions on Connecting Noise Filter*.

(2) Correct Grounding

Take the following grounding measures to prevent the malfunction due to noise.

■ Grounding the Motor Frame

Always connect servomotor frame terminal FG to the SERVOPACK ground terminal ⊕. Also be sure to ground the ground terminal ⊕.

If the servomotor is grounded via the machine, a switching noise current will flow from the SERVOPACK main circuit through servomotor stray capacitance. The above grounding is required to prevent the adverse effects of switching noise.

■ Noise on the I/O Signal Line

If the I/O signal lines are affected by noise, ground the 0 V (SG) terminal of I/O signal. If the main circuit wiring for the motor is in a metal conduit, ground the conduit and its junction box. For all grounding, ground at one point only.

3.8.2 Precautions on Connecting Noise Filter

This section describes the precautions on installing a noise filter.

(1) Noise Filter for Brake Power Supply

Use the following noise filter at the brake power input for 400 W or less servomotors with holding brakes.

MODEL: FN2070-6/07 (Manufactured by SCHAFFNER Electronic.)

(2) Precautions on Using Noise Filters

Always observe the following installation and wiring instructions.



IMPORTANT

Some noise filters have large leakage currents. The grounding measures taken also affects the extent of the leakage current. If necessary, select an appropriate leakage current detector or leakage current breaker taking into account the grounding measures that are used and leakage current from the noise filter. Contact the manufacturer of the noise filter for details.

Do not put the input and output lines in the same duct or bundle them together.

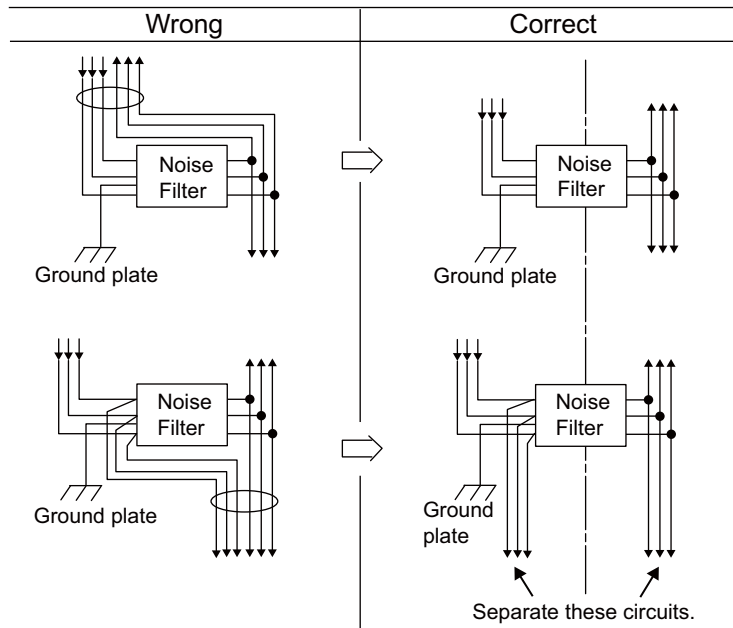

Separate the noise filter ground wire from the output lines.

Do not put the noise filter ground wire, output lines and other signal lines, in the same duct or bundle them together.

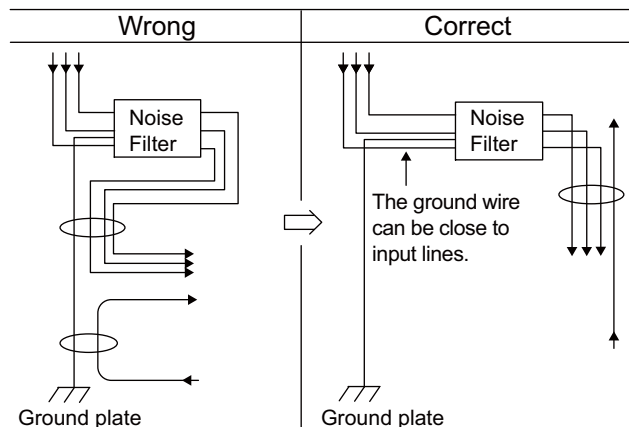

Connect the noise filter ground wire directly to the ground plate.
Do not connect the noise filter ground wire to other ground wires.

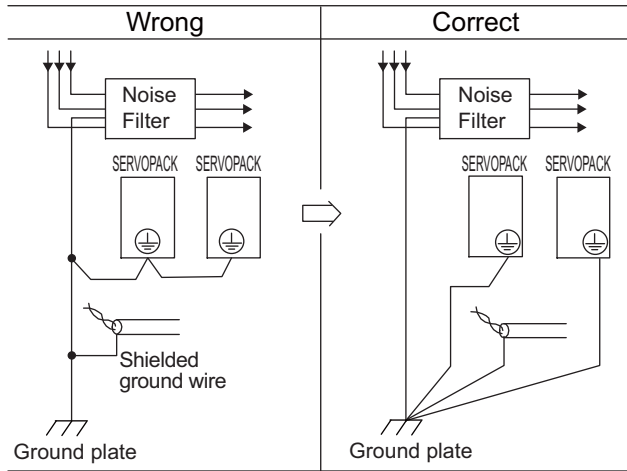

If a noise filter is located inside a control panel, connect the noise filter ground wire and the ground wires from other devices inside the control panel to the ground plate for the control panel first, then ground these wires.

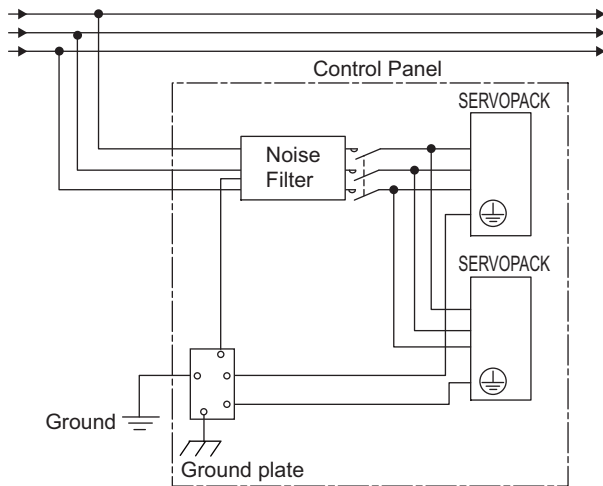

3.8.3 Connecting AC/DC Reactor for Harmonic Suppression

The SERVOPACK has reactor connection terminals for power supply harmonic suppression. As for the precautions on selecting an AC or DC reactor and its specifications, refer to *Σ-V series Product Catalog* (KAEP S800000 42).

Connect a reactor as shown in the following diagram.

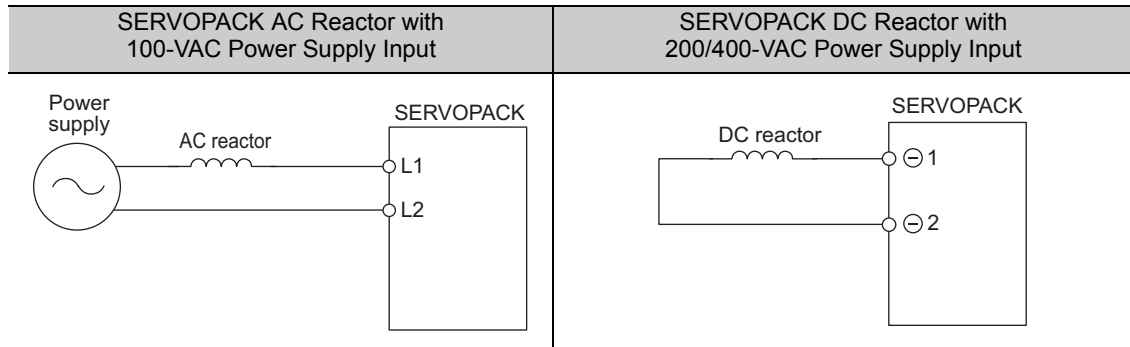

- Note 1. Connection terminals for DC reactor $\ominus 1$ and $\ominus 2$ are short-circuited at shipment. Remove the lead wire for short-circuit, and connect a DC reactor.
2. AC and DC reactors are not provided. (option)
 3. A SERVOPACK with a single-phase, 100-V power supply input cannot be connected to a DC reactor.

4.1	Option Module Function Settings	4-2
4.1.1	Setting Switches S1 and S2 for Option Module Functions	4-2
4.2	Settings for Common Basic Functions	4-3
4.2.1	Inspection and Checking before Operation	4-3
4.2.2	Servomotor Rotation Direction	4-4
4.2.3	Overtravel	4-5
4.2.4	Electronic Gear	4-8
4.2.5	Encoder Output Pulses	4-11
4.2.6	Encoder Output Pulse Setting	4-12
4.2.7	Holding Brakes	4-13
4.2.8	Stopping Servomotor after Receiving Servo OFF Command or Alarm Occurrence	4-18
4.2.9	Instantaneous Power Interruption Settings	4-20
4.2.10	SEMI-F47 Function (Torque Limit Function for Low Power Supply Voltage for Main Circuit)	4-21
4.2.11	Setting Motor Overload Detection Level	4-24
4.3	Test Without Motor Function	4-26
4.3.1	Related Parameters	4-26
4.3.2	Limitations	4-27
4.3.3	Digital Operator Display during Testing without Motor	4-28
4.4	Limiting Torque	4-29
4.4.1	Internal Torque Limit	4-29
4.4.2	External Torque Limit	4-30
4.4.3	Checking Output Torque Limiting during Operation	4-31
4.5	Absolute Encoders	4-32
4.5.1	Connecting the Absolute Encoder	4-33
4.5.2	Absolute Data Request (Sensor ON Command)	4-35
4.5.3	Battery Replacement	4-36
4.5.4	Absolute Encoder Setup (Initialization)	4-38
4.5.5	Absolute Encoder Reception Sequence	4-39
4.5.6	Multiturn Limit Setting	4-42
4.5.7	Multi-turn Limit Disagreement (A.CC0)	4-43
4.6	Safety Function	4-44
4.6.1	Hard Wire Base Block (HWBB) Function	4-44
4.6.2	External Device Monitor (EDM1)	4-49
4.6.3	Application Example of Safety Functions	4-51
4.6.4	Confirming Safety Functions	4-52
4.6.5	Connecting a Safety Device	4-53
4.6.6	Precautions for Safety Functions	4-54

4.1 Option Module Function Settings

This section describes how to set the option module functions.

4.1.1 Setting Switches S1 and S2 for Option Module Functions

The S1 and S2 Switches are used to make the settings for the Option Module Functions.

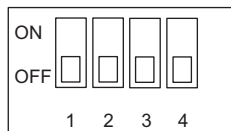

S2 (factory setting)

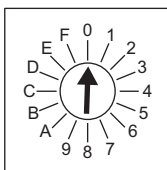

S1 (factory settings)

For details on S1 and S2 switches, refer to the manual of the connected command option module.

4.2 Settings for Common Basic Functions

This section explains the settings for the common basic functions.

4.2.1 Inspection and Checking before Operation

To ensure safe and correct operation, inspect and check the following items before starting operation.

(1) Servomotors

Inspect and check the following items and take appropriate measures before performing operation if any problem exists.

- Are all wiring and connections correct?
- Are all nuts and bolts securely tightened?
- Does the motor have an oil seal? If so, is the oil shield in good condition without any damage?
- Does the motor have an oil seal? If so, does the oil have a coating?

Note: When performing operation on a servomotor that has been stored for a long period of time, perform the maintenance and inspection according to the procedures described in *1.8 Inspection and Maintenance*.

(2) SERVOPACKs

Inspect and check the following items and take appropriate measures before performing operation if any problem exists.

- Are all wiring and connections correct?
- Is the correct power supply voltage being supplied to the SERVOPACK?

(3) Operating the Servomotor Alone

JOG operation of the SERVOPACK enables checking servomotor operation using speed control without connection to the host controller. For details, refer to the *Σ-V Series Users Manual Setup Rotational Motor* (SIEP S800000 43). For details on how to perform operation using the command option module functions, refer to the manual of the connected command option module.

4.2.2 Servomotor Rotation Direction

The servomotor rotation direction can be reversed with parameter Pn000 without changing the polarity of the speed/position reference.

This causes the travel direction of the motor change, but the encoder pulse output polarity does not change.

The standard setting for forward rotation is counterclockwise (CCW) as viewed from the load end of the servomotor.

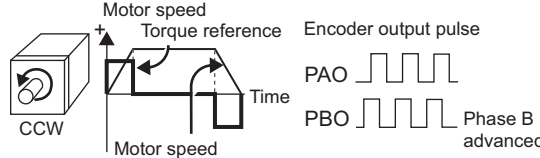
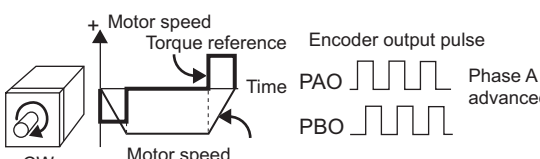
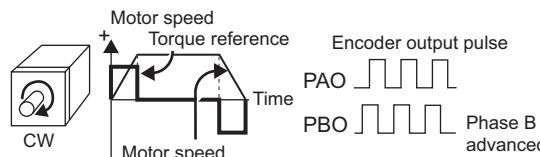
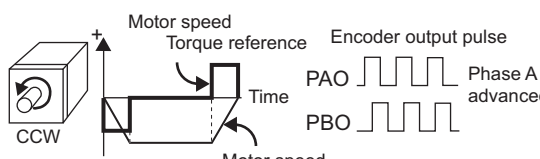
Parameter	Forward/Reverse Reference	Direction of Motor Rotation and Encoder Output Pulse	Applicable Overtravel (OT)
Pn000	n.□□□0 Sets CCW as forward direction. [Factory setting]	Forward Reference 	P-OT
		Reverse Reference 	N-OT
	n.□□□1 Sets CW as forward direction. (Reverse Rotation Mode)	Forward Reference 	P-OT
		Reverse Reference 	N-OT

Note: SigmaWin+ trace waveforms are shown in the above table.

4.2.3 Overtravel

The overtravel limit function forces movable machine parts to stop if they exceed the allowable range of motion and turn ON a limit switch.

For rotating application such as disc table and conveyor, overtravel function is not necessary. In such a case, no wiring for overtravel input signals is required.

CAUTION

- **Installing limit switches**
 For machines that move using linear motion, connect limit switches to P-OT and N-OT of CN1 as shown below to prevent machine damage. To prevent a contact fault or disconnection from causing accidents, make sure that the limit switches are normally closed.
- **Axes to which external force is applied in overtravel**
 Vertical axes:
 Occurrence of overtravel may cause a workpiece to fall, because the /BK signal is on, that is when the brake is released. Set the parameter (Pn001 = n.□□1□) to bring the servomotor to zero clamp state after stopping to prevent a workpiece from falling.
 Other axes to which external force is applied:
 Overtravel will bring about a baseblock state after the servomotor stops, which may cause the servomotor to be pushed back by the load's external force. To prevent this, set the parameter (Pn001 = n.□□1□) to bring the servomotor to zero clamp state after stopping.
 For details on how to set the parameter, refer to (3) *Servomotor Stopping Method When Overtravel is Used*.

(1) Signal Setting

Type	Name	Connector Pin Number	Setting	Meaning
Input	P-OT	CN1-7	ON	Forward run allowed. Normal operation status.
			OFF	Forward run prohibited. Forward overtravel.
	N-OT	CN1-8	ON	Reverse run allowed. Normal operation status.
			OFF	Reverse run prohibited. Reverse overtravel.

Rotation in the opposite direction is possible during overtravel by inputting the reference.

(2) Overtravel Function Setting

Parameters Pn50A and Pn50B can be set to enable or disable the overtravel function.

If the overtravel function is not used, no wiring for overtravel input signals will be required.

Parameter		Meaning	When Enabled	Classification
Pn50A	n.1□□□ [Factory setting]	Inputs the Forward Run Prohibited (P-OT) signal from CN1-7.	After restart	Setup
	n.8□□□	Disables the Forward Run Prohibited (P-OT) signal. Allows constant forward rotation.		
Pn50B	n.□□□2 [Factory setting]	Inputs the Reverse Run Prohibited (N-OT) signal from CN1-8.		
	n.□□□8	Disables the Reverse Run Prohibited (N-OT) signal. Allows constant reverse rotation.		

A parameter can be used to re-allocate input connector number for the P-OT and N-OT signals. Refer to 3.3.1 *Input Signal Allocations* for details.

(3) Servomotor Stopping Method When Overtravel is Used

There are three servomotor stopping methods when an overtravel is used.

- Dynamic brake
By short-circuiting the electric circuits, the servomotor comes to a quick stop.
- Decelerate to a stop
Stops by using emergency stop torque.
- Coast to a stop
Stops naturally, with no control, by using the friction resistance of the servomotor in operation.

After servomotor stopping, there are two modes.

- Coast mode
Stopped naturally, with no control, by using the friction resistance of the servomotor in operation.
- Zero clamp mode
A mode forms a position loop by using the position reference zero.

The servomotor stopping method when an overtravel (P-OT, N-OT) signal is input while the servomotor is operating can be set with parameter Pn001.

Parameter	Stop Method	Mode After Stopping	When Enabled	Classification	
Pn001	n.□□00 [Factory setting]	DB	After restart	Setup	
	n.□□01				
	n.□□02	Coast			
	n.□□1□	Deceleration to a stop			Zero clamp
	n.□□2□				Coast

- A servomotor under torque control cannot be decelerated to a stop. The servomotor is stopped with the dynamic braking (DB) or coasts to a stop according to the setting of Pn001.0. After the servomotor stops, the servomotor will enter a coast state.
- For details on servomotor stopping methods after the SV_OFF command is received or an alarm occurs, refer to 4.2.8 *Stopping Servomotor after Receiving Servo OFF Command or Alarm Occurrence*.

■ When Servomotor Stopping Method is Set to Decelerate to Stop

Emergency stop torque can be set with Pn406.

Pn406	Emergency Stop Torque				Classification
	Setting Range	Setting Unit	Factory Setting	When Enabled	
	0 to 800	1%	800	Immediately	

- The setting unit is a percentage of the rated torque.
- The factory setting is 800% so that the setting is large enough a value to operate the servomotor at maximum torque. The maximum value of emergency stop torque that is actually available, however, is limited to the maximum torque of the servomotor.

(4) Overtravel Warning Function

This function detects an overtravel warning (A.9A0) if overtravel occurs while the servomotor power is ON. Using this function enables notifying the host controller when the SERVOPACK detects overtravel even if the overtravel signal is ON only momentarily.

To use the overtravel warning function, set digit 4 of Pn00D to 1 (detects overtravel warning).

Note: The overtravel warning function is supported by software version 001A or later. The software version can be checked with Fn012. For details, refer to 6.14 *Software Version Display (Fn012)*.

■ Warning Output Timing

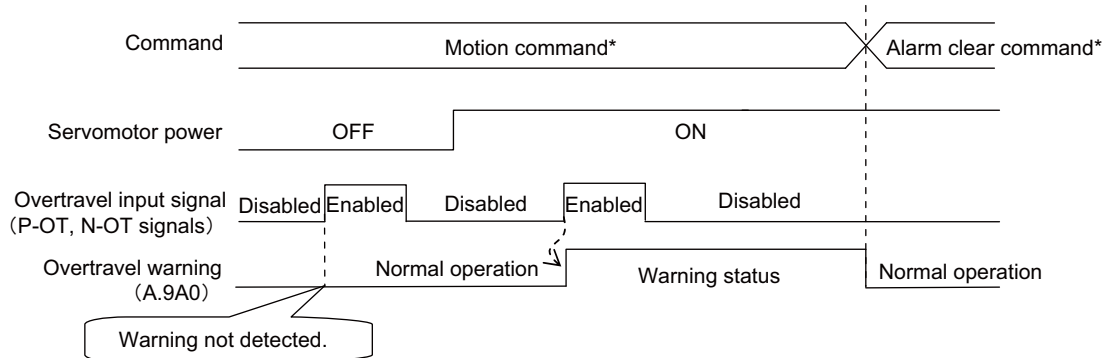

* For details, refer to the manual for the connected command option module.

<Notes>

- Warnings are detected for overtravel in the same direction as the reference.
- Warnings are not detected for overtravel in the reverse direction from the reference.
Example: A warning will not be output for a forward reference even if the N-OT signal (reverse run prohibited) turns ON.
- A warning can be detected in either the forward or reverse direction, when there is no reference.
- A warning will not be detected when the servomotor power is OFF even if overtravel occurs.
- A warning will not be detected when the servomotor power changes from OFF to ON even if overtravel status exists.
- To clear the overtravel warning, send an alarm clear command regardless of the status of the servomotor power and the overtravel signal. If the warning is cleared by this method during an overtravel state, the occurrence of the warning will not be indicated until the overtravelling is corrected and reset.

⚠ CAUTION

- The overtravel warning function only detects warnings. It does not affect on stopping for overtravel or motion operations at the host controller. The next step (e.g., the next motion or other command) can be executed even if an overtravel warning exists. However, depending on the processing specifications and programming for warnings in the host controller, operation may be affected when an overtravel warning occurs (e.g., motion may stop or not stop). Confirm the specifications and programming in the host controller.
- When an overtravel occurs, the SERVOPACK will perform stop processing for overtravel. Therefore, when an overtravel warning occurs, the servomotor may not reach the target position specified by the host controller. Check the feedback position to make sure that the axis is stopped at a safe position.

■ Related Parameter

Parameter	Meaning	When Enabled	Classification
Pn00D	n.0□□□ [Factory setting]	Does not detect overtravel warning.	Immediately Setup
	n.1□□□	Detects overtravel warning.	

4.2.4 Electronic Gear

The electronic gear enables the workpiece travel distance per input reference pulse from the host controller to be set to any value. The minimum position data moving a load is called a reference unit.

To move a workpiece 10 mm:

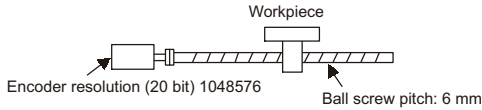

When the Electronic Gear is Not Used:

- ① Calculate the revolutions.
1 revolution is 6 mm. Therefore, 10/6 revolutions.
- ② Calculate the required reference pulses.
1048576 pulses is 1 revolution. Therefore, 10/6 × 1048576 = 1747626.66... pulses.
- ③ Input 1746928 pulses as reference pulses.

Reference pulses must be calculated per reference. → complicated

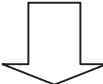

When the Electronic Gear is Used:

The reference unit is 1 μm. Therefore, to move the workpiece 10 mm (10000μm),
1 pulse = 1μm, so 10000 ÷ 1 = 10000 pulses.
Input 10000 pulses as reference pulses.

Calculation of reference pulses per reference is not required. → simplified

(1) Electric Gear Ratio

Set the electric gear ratio using Pn20E and Pn210.

Pn20E	Electronic Gear Ratio (Numerator) Position				Classification
	Setting Range	Setting Unit	Factory Setting	When Enabled	
	1 to 1073741824	1	4	After restart	Setup
Pn210	Electronic Gear Ratio (Denominator) Position				Classification
	Setting Range	Setting Unit	Factory Setting	When Enabled	
	1 to 1073741824	1	1	After restart	Setup

If the gear ratio of the motor and the load shaft is given as n/m where m is the rotation of the motor and n is the rotation of the load shaft,

$$\text{Electronic gear ratio: } \frac{B}{A} = \frac{Pn20E}{Pn210} = \frac{\text{Encoder resolution}}{\text{Travel distance per load shaft revolution (reference units)}} \times \frac{m}{n}$$

Encoder Resolution

Encoder resolution can be checked with servomotor model designation.

SGMOV-□□□□□□□□

Symbol	Specification	Encoder Resolutions
3	20-bit absolute	1048576
D	20-bit incremental	1048576
A	13-bit incremental	8192

SGMPS -□□□□□□□□

Symbol	Specification	Encoder Resolutions
2	17-bit absolute	131072
C	17-bit incremental	131072



IMPORTANT

Electronic gear ratio setting range: $0.001 \leq \text{Electronic gear ratio (B/A)} \leq 4000$

If the electronic gear ratio is outside this range, a parameter setting error (A.040) will be output.

(2) Procedure for Setting the Electronic Gear Ratio

Set value electric gear differs depending on the machine specifications. Use the following procedure to set the electronic gear ratio.

Step	Operation
1	Check machine specifications. Check the gear ratio, ball screw pitch, and pulley diameter.
2	Check the encoder resolution. Check the encoder resolution for the servomotor used.
3	Determine the reference unit used. Determine the reference unit from the host controller, considering the machine specifications and positioning accuracy.
4	Calculate the travel distance per load shaft revolution. Calculate the number of reference units necessary to turn the load shaft one revolution based on the previously determined reference units.
5	Calculate the electronic gear ratio. Use the electronic gear ratio equation to calculate the ratio (B/A).
6	Set parameters. Set parameters Pn20E and Pn210 using the calculated values.
7	Turn OFF the power and ON again to enable the settings.

(3) Electronic Gear Ratio Equation

Refer to the following equation to determine the electric gear ratio.

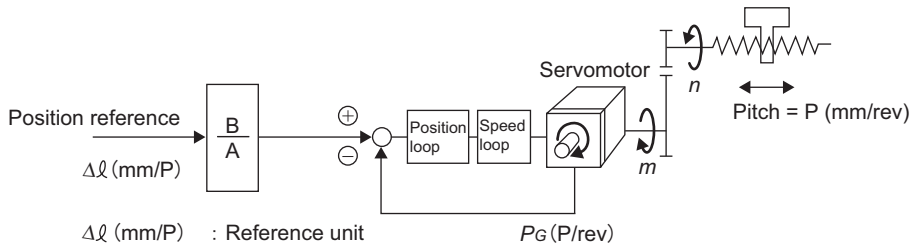

Δl (mm/P) : Reference unit
 P_G (P/rev) : Encoder resolution
 P (mm/rev) : Ball screw pitch
 $\frac{n}{m}$: Gear ratio (m is the rotation of the motor and n is the rotation of the load shaft.)

$$\frac{n \times P}{\Delta l} \times \left(\frac{B}{A}\right) = P_G \times m$$

$$\left(\frac{B}{A}\right) = \frac{P_G \times m \times \Delta l}{n \times P} = \frac{P_G}{\Delta l} \times \frac{m}{n}$$

Set A and B with the following parameters.
[A]: Pn210 **[B]**: Pn20E

(4) Electronic Gear Ratio Setting Examples

The following examples show electronic gear ratio settings for different load configurations.

Step	Operation	Load Configuration		
		Ball Screw	Disc Table	Belt and Pulley
		Reference unit: 0.001 mm Load shaft 	Reference unit: 0.01° 	Reference unit: 0.005 mm Load shaft
1	Check machine specifications.	<ul style="list-style-type: none"> Ball screw pitch: 6 mm Gear ratio: 1/1 	<ul style="list-style-type: none"> Rotation angle per revolution: 360° Gear ratio: 1/100 	<ul style="list-style-type: none"> Pulley diameter: 100 mm (pulley circumference: 314 mm) Gear ratio: 1/50
2	Check the encoder resolution.	1048576 (20-bit)	1048576 (20-bit)	1048576 (20-bit)
3	Determine the reference unit used.	Reference unit: 0.001 mm (1 μm)	Reference unit: 0.01°	Reference unit: 0.005 mm (5 μm)
4	Calculate the travel distance per load shaft revolution.	6 mm/0.001 mm=6000	360°/0.01°=36000	314 mm/0.005 mm=62800
5	Calculate the electronic gear ratio.	$\frac{B}{A} = \frac{1048576}{6000} \times \frac{1}{1}$	$\frac{B}{A} = \frac{1048576}{36000} \times \frac{100}{1}$	$\frac{B}{A} = \frac{1048576}{62800} \times \frac{50}{1}$
6	Set parameters.	Pn20E: 1048576	Pn20E: 104857600	Pn20E: 52428800
		Pn210: 6000	Pn210: 36000	Pn210: 62800

4.2.5 Encoder Output Pulses

Encoder output pulse is the signal which processes the encoder output inside the SERVOPACK and then outputs externally in the form of 2-phase pulses (phase A and B) with 90° phase differential. It is used as the feedback of position.

Signals and output phase form are as shown below.

(1) Signals

Type	Signal Name	Connector Pin Number	Name	Remarks
Output	PAO	CN1-17	Encoder output pulse: phase A	Output pulses per motor rotation set in the encoder output pulses (Pn212), and phase A and phase B are different from each other in phase by an electric angle of 90°.
	/PAO	CN1-18	Encoder output pulse: phase /A	
	PBO	CN1-19	Encoder output pulse: phase B	
	/PBO	CN1-20	Encoder output pulse: phase /B	
	PCO	CN1-21	Encoder output pulse: phase C	One pulse is output per motor rotation.
	/PCO	CN1-22	Encoder output pulse: phase /C	

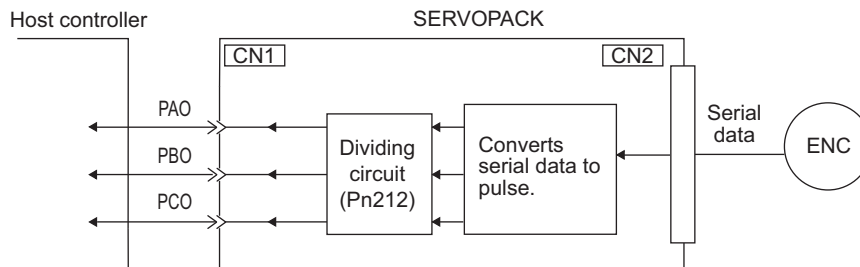

(2) Output Phase Form

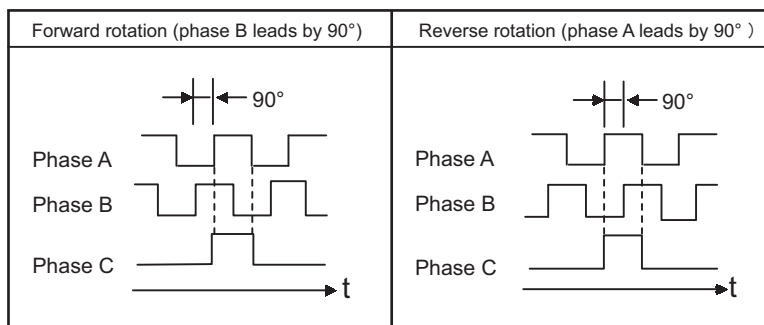

Note: The pulse width of the (Phase C origin pulse) changes according to the setting of the Pn212 and becomes the same as that for phase A.

Even in reverse rotation mode (Pn000.0 = 1), the output phase form is the same as that for the standard setting (Pn000.0 = 0).



IMPORTANT

If using the SERVOPACK's phase-C pulse output for a zero point return, rotate the servomotor twice before starting a zero point return. If the configuration prevents the servomotor from returning to the zero point by rotating the servomotor twice, perform a zero point return at a motor speed of 600 min⁻¹ or below. If the motor speed is faster than 600 min⁻¹, the phase-C pulse output may not be output correctly.

4.2.6 Encoder Output Pulse Setting

Set the encoder output pulse using the following parameter.

Pn212	Encoder Output Pulses Speed Position Torque				Classification
	Setting Range	Setting Unit	Factory Setting	When Enabled	
	16 to 1073741824	1 P/Rev	2048	After restart	Setup

Pulses from the encoder per revolution are divided inside the SERVOPACK by the number set in this parameter before being output. Set according to the system specifications of the machine or host controller.

According to the encoder resolution, the number of encoder output pulses are limited. Set the encoder output pulses (Pn212) by the following setting unit.

Setting Range of Encoder Output Pulses (P/Rev)	Setting Unit (pulse)	Encoder Resolution			Upper Limit of Servomotor Speed for Set Encoder Output Pulses (min^{-1})
		13 bits (8,192 pulses)	17 bits (131,072 pulses)	20 bits (1,048,576 pulses)	
16 to 2048	1	✓	–	–	6000
16 to 16384	1	–	✓	✓	6000
16386 to 32768	2	–	✓	✓	3000
32772 to 65536	4	–	–	✓	1500
65544 to 131072	8	–	–	✓	750
131088 to 262144	16	–	–	✓	375

Note 1. The setting range varies with the encoder resolution for the servomotor used.

An encoder output pulse setting error (A.041) will occur if the setting is outside the allowable range or does not satisfy the setting conditions.

Pn212 = 25000 (P/Rev) is accepted, but

Pn212 = 25001 (P/Rev) is not accepted. The alarm A.041 is output because the setting unit differs from that in the above table.

2. The upper limit of the pulse frequency is approx. 1.6 Mpps.

The servomotor speed is limited if the setting value of the encoder output pulses (Pn212) is large.

An overspeed of encoder output pulse rate alarm (A.511) will occur if the motor speed exceeds the upper limit specified in the above table.

Output Example: When Pn212 = 16 (16-pulse output per one revolution), PAO and PBO are output as shown below.

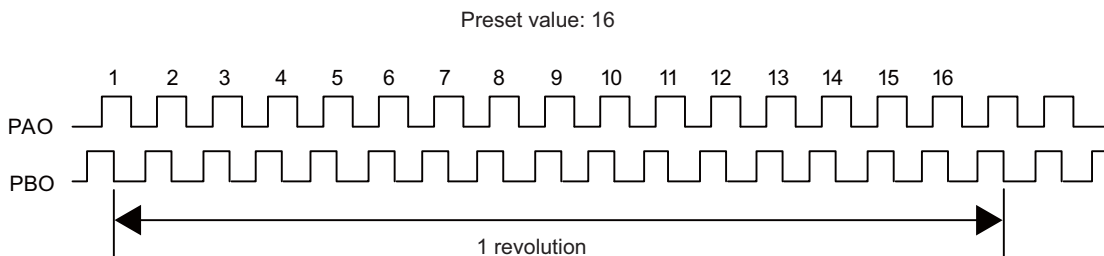

4.2.7 Holding Brakes

A holding brake is a brake used to hold the position of the movable part of the machine when the SERVO-PACK is turned OFF so that movable part does not move due to gravity or external forces. Holding brakes are built into servomotors with brakes.

The holding brake is used in the following cases.

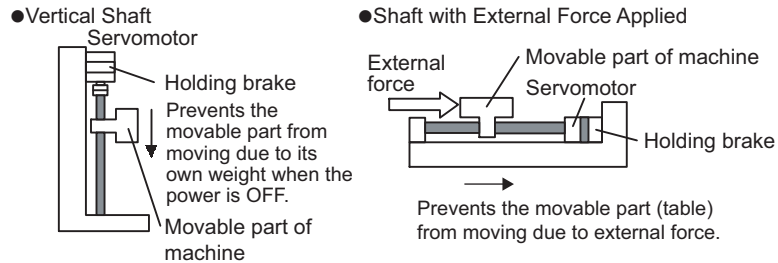

IMPORTANT

- The brake built into the servomotor with brakes is a de-energization brake, which is used only to hold and cannot be used for braking. Use the holding brake only to hold a stopped servomotor.

There is a delay in the braking operation. Set the following ON/OFF timing.

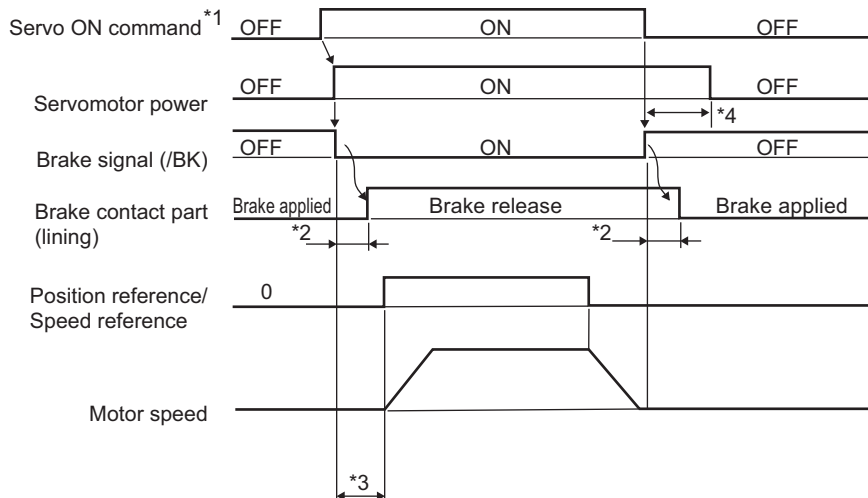

- *1. For details, refer to the manual for the command option module that is connected.
- *2. The operation delay time of the brake depends on the model. For details, refer to *Brake Operation Delay Time* shown below.
- *3. After the Servo ON command has been sent and 50 ms has passed since the brake was released, output the reference from the host controller to the SERVOPACK.
- *4. Use Pn506, Pn507, and Pn508 to set the timing of when the brake will be activated and when the servomotor power will be turned OFF.

Brake Operation Delay Time

Model	Voltage	Brake Release Time (ms)	Brake Applied Time (ms)
SGMJV-A5 to 04	24 VDC	60	100
SGMJV-08		80	100
SGMAV-A5 to 04		60	100
SGMAV-06 to 10		80	100
SGMPS-01, -08		20	100
SGMPS-02, -04, -15		40	100
SGMGV-03 to 20	24 VDC, 90 VDC	100	80
SGMGV-30, -44		170	100 (24 VDC), 80 (90 VDC)
SGMGV-55, -75, -1A		170	80
SGMGV-1E		250	80
SGMSV-10 to 25		170	80
SGMSV-30 to 50		100	80

Note: The above operation delay time is an example when the power supply is turned ON and OFF on the DC side.
Be sure to evaluate the above times on the actual equipment before using the application.

(1) Wiring Example

Use the brake signal (/BK) and the brake power supply to form a brake ON/OFF circuit. The following diagram shows a standard wiring example.

The timing can be easily set using the brake signal (/BK).

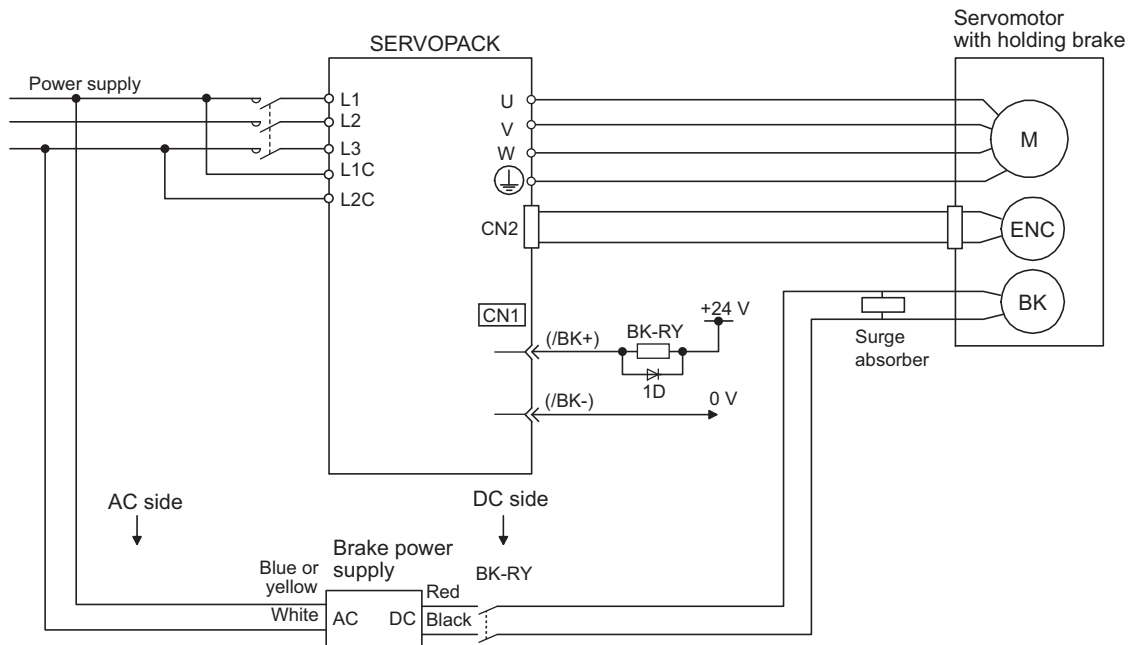

BK-R Y: Brake control relay

Brake power supply for 90 V Input voltage 200-V models: LPSE-2H01-E
Input voltage 100-V models: LPDE-1H01-E

A 24 VDC power supply is not included.



IMPORTANT

- Select the optimum surge absorber in accordance with the applied brake current and brake power supply.
 When using the LPSE-2H01-E power supply: Z10D471 (Made by SEMITEC Corporation)
 When using the LPDE-1H01-E power supply: Z10D271 (Made by SEMITEC Corporation)
 When using the 24-V power supply: Z15D121 (Made by SEMITEC Corporation)
- After the surge absorber is connected, check the total time the brake is applied for the system. Depending on the surge absorber, the total time the brake is applied can be changed.
- Configure the relay circuit to apply the holding brake by the emergency stop.

Relay Circuit Example

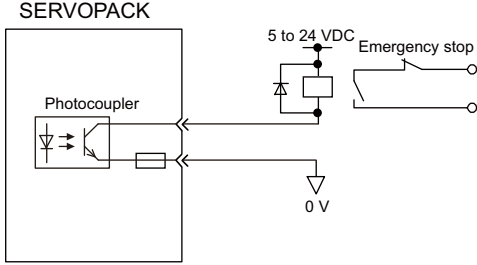

- The allocation of the /BK signal can be changed. Refer to (3) *Brake Signal (/BK) Allocation* to set the parameter Pn50F.
- When using a 24-V brake, separate the 24-VDC power supply from other power supplies, such as the one used for the I/O signals of CN1 connectors. Always install the 24-VDC power supply separately. If the power supply is shared, the I/O signals might malfunction.

(2) Brake Signal (/BK) Setting

This output signal controls the brake. The allocation of the /BK signal can be changed. Refer to (3) *Brake Signal (/BK) Allocation* for allocation.

The /BK signal turns OFF (applies the brake) when an alarm is detected or the servomotor power is OFF. The brake OFF timing can be adjusted with Pn506.

Type	Name	Connector Pin Number	Setting	Meaning
Output	/BK	CN1-1, CN1-2	ON (closed)	Releases the brake.
			OFF (open)	Applies the brake.



IMPORTANT

The /BK signal is still ON during overtravel and the brake is still released.

(3) Brake Signal (/BK) Allocation

Use parameter Pn50F.2 to allocate the /BK signal.

Parameter	Connector Pin Number		Meaning	When Enabled	Classification	
	+ Terminal	- Terminal				
Pn50F	n.□0□□	–	–	The /BK signal is not used.	After restart	Setup
	n.□1□□ [Factory setting]	CN1-1	CN1-2	The /BK signal is output from output terminal CN1-1, 2.		
	n.□2□□	CN1-23	CN1-24	The /BK signal is output from output terminal CN1-23, 24.		
	n.□3□□	CN1-25	CN1-26	The /BK signal is output from output terminal CN1-25, 26.		



When multiple signals are allocated to the same output terminal, the signals are output with OR logic. For the /BK signal, do not use the output terminal that is already being used for another signal.

IMPORTANT

(4) Brake ON Timing after the Servomotor Stops

When the servomotor stops, the /BK signal turns OFF at the same time as the servo ON command is turned OFF. Use parameter Pn506 to change the timing at which the servo ON command turns OFF and power is not supplied to the motor.

Pn506	Brake Reference-Servo OFF Delay Time				Classification
	Setting Range	Setting Unit	Factory Setting	When Enabled	
	0 to 50	10 ms	0	Immediately	

- When using the servomotor to control a vertical axis, the machine movable part may shift slightly depending on the brake ON timing due to gravity or an external force. To eliminate this slight shift, set parameter so that the power to the servomotor turns OFF after the brake is applied.
- This parameter changes the brake ON timing while the servomotor is stopped.

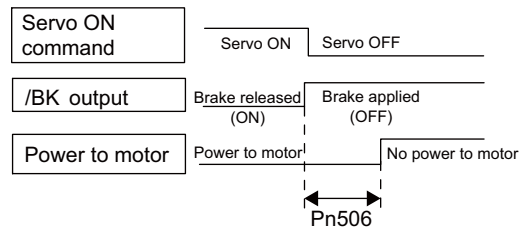



The servomotor will turn OFF immediately when an alarm occurs, regardless of the setting of this parameter. The machine movable part may shift due to gravity or external force before the brake operates.

IMPORTANT

(5) Brake Signal (/BK) Output Timing during Servomotor Rotation

If an alarm occurs while the servomotor is rotating, the servomotor will come to a stop and the brake signal (/BK) will be turned OFF. The timing of brake signal (/BK) output can be adjusted by setting the brake reference output speed level (Pn507) and the waiting time for brake signal when motor running (Pn508).

Note: If the servomotor is set so that it comes to a zero-speed stop for an alarm, follow the information in (4) *Brake ON Timing after the Servomotor Stops* after the servomotor comes to a stop for a zero position reference.

Pn507	Brake Reference Output Speed Level Speed Position Torque				Classification
	Setting Range	Setting Unit	Factory Setting	When Enabled	
	0 to 10000	1 min ⁻¹	100	Immediately	Setup
Pn508	Waiting Time for Brake Signal When Motor Running Speed Position Torque				Classification
	Setting Range	Setting Unit	Factory Setting	When Enabled	
	10 to 100	10 ms	50	Immediately	Setup

/BK Signal Output Conditions When Servomotor Rotating

The /BK signal goes to high level (brake ON) when either of the following conditions is satisfied:

- When the motor speed falls below the level set in Pn507 after the power to the servomotor is turned OFF.
- When the time set in Pn508 is exceeded after the power to the servomotor is turned OFF.

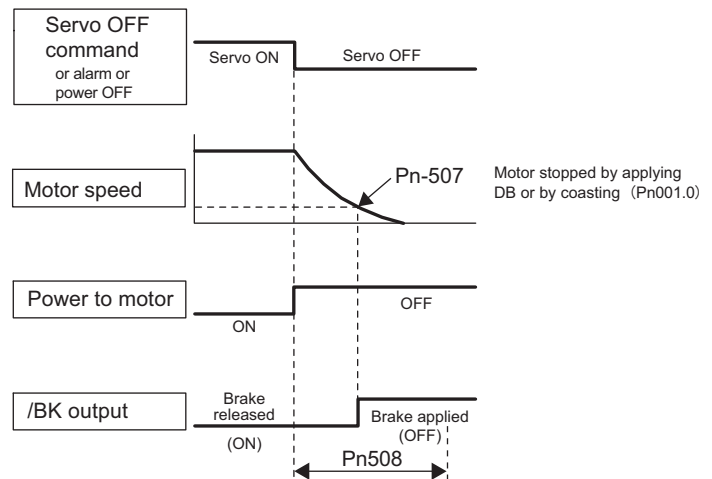

IMPORTANT

- The servomotor will be limited to its maximum speed even if the value set in Pn507 is higher than the maximum speed.
- Do not allocate the rotation detection signal (/TGON) and the brake signal (/BK) to the same terminal. The /TGON signal will otherwise be turned ON by the falling speed on a vertical axis, and the brake may not operate. For the /BK signal, do not use the terminal that is already being used for another signal.

4.2.8 Stopping Servomotor after Receiving Servo OFF Command or Alarm Occurrence

The stopping method can be selected after the servo OFF command is received or an alarm occurs.



IMPORTANT

- Dynamic braking (DB) is used for emergency stops. The DB circuit will operate frequently if the power is turned ON and OFF with a reference input applied, which may result in deterioration of the internal elements in the SERVOPACK.
Use speed input references or position references to start and stop the servomotor.
- If the main circuit power supply (L1, L2, and L3) or the control power supply (L1C, L2C or 24V, 0V depending on the SERVOPACK model) is turned OFF before the servo OFF command is received, the stopping method for servomotor cannot be set by parameters.
 - If turning OFF the main circuit power supply before the servo OFF command is received, the servomotor will be stopped by dynamic braking.
 - If turning OFF the control power supply before the servo OFF command is received, the stopping method will vary with the SERVOPACK model. Two stopping methods are available.
 - Coasting
Applicable models: SGD V-330A, 470A, 550A, 590A, 780A, 280D, 370D
 - Dynamic braking
Applicable models: All SERVOPACKs other than those listed for coasting.
- If the servomotor must be stopped during operation by coasting rather than by dynamic braking when the main circuit power supply or the control power supply is OFF, arrange the sequence externally so the current will be cut off for wires U, V, and W.
- To minimize the coasting distance of the motor to come to a stop, the zero-speed stopping method is factory-set for alarms to which the zero-speed stop method is applicable. The DB stopping method may be more suitable than the zero-speed stopping method, however, depending on the application. Change the method to the DB stopping method as required by the application.
For example, for multiple axes coupling operation (a twin-drive operation), machinery damage may result if a zero-speed stop alarm occurs for one of the coupled shafts and the other shaft stops by dynamic brake. In such cases, change the method to the DB stopping method.

(1) Stopping Method for Servomotor After Servo OFF Command is Received

Use Pn001.0 to select the stopping method for the servomotor after the servo OFF command is received.

Parameter	Stop Mode	Mode After Stopping	Meaning	When Enabled	Classification
Pn001	n.□□□0	Stop by dynamic brake	Dynamic Brake	After restart	Setup
	n.□□□1		Coast		
	n.□□□2	Coast to a stop	Coast		

Note: Similar to the Coast Mode, the n.□□□0 setting (which stops the servomotor by dynamic braking and then holds it in Dynamic Brake Mode) does not generate any braking force when the servomotor stops or when it rotates at very low speed.

(2) Stopping Method for Servomotor When an Alarm Occurs

There are two type of alarms (Gr.1 and Gr.2), depending on the stopping method when an alarm occurs.

Select the stopping method for the servomotor when an alarm occurs using Pn001.0 and Pn00B.1.

The stopping method for the servomotor for a Gr.1 alarm is set to Pn001.0.

The stopping method for the servomotor for a Gr.2 alarm is set to Pn00B.1.

Refer to the information on alarm stopping methods in *9.1.1 List of Alarms*.

■ Stopping Method for Servomotor for Gr.1 Alarms

The stopping method of the servomotor when a Gr.1 alarm occurs is the same as that for the servomotor after the servo OFF command is received.

Parameter		Stop Mode	Mode After Stopping	Meaning	When Enabled	Classification
Pn001	n.□□□0	Stop by dynamic brake	Dynamic Brake	Stops the servomotor by dynamic braking (DB), then holds it in Dynamic Brake Mode. [Factory setting]	After restart	Setup
	n.□□□1		Coast	Stops the servomotor by dynamic braking (DB), then places it into Coast Mode.		
	n.□□□2	Coast to a stop	Coast	Stops the servomotor by coasting, and continues in Coast Mode.		

■ Stopping Method for Servomotor for Gr.2 Alarms

Parameter		Stop Mode	Mode After Stopping	Meaning	When Enabled	Classification
Pn00B	Pn001					
n.□□□□ [Factory setting]	n.□□□0 [Factory setting]	Zero-speed stopping*	Dynamic Brake	Stops the servomotor by zero-speed stop, then holds it in Dynamic Brake Mode.	After restart	Setup
	n.□□□1		Coast	Stops the servomotor by zero-speed stop, then places it into Coast Mode.		
	n.□□□2			Stops the servomotor by zero-speed stop, then places it into Coast Mode.		
n.□□1□	n.□□□0 [Factory setting]	Stops by dynamic brake	Dynamic Brake	Stops the servomotor by dynamic braking (DB), then holds it in Dynamic Brake Mode.	After restart	Setup
	n.□□□1		Coast	Stops the servomotor by dynamic braking (DB), then places it into Coast Mode.		
	n.□□□2	Coast to stop		Stops the servomotor by coasting, and continues in Coast Mode.		

* Zero-speed stopping : The speed reference is set to 0 to stop quickly.

Note: The setting of Pn00B.1 is effective for position control and speed control. Pn00B.1 will be ignored for torque control and only the setting of Pn001.0 will be valid.

4.2.9 Instantaneous Power Interruption Settings

Determines whether to continue operation or turn the servomotor's power OFF when the power supply voltage is interrupted.

Pn509	Instantaneous Power Cut Hold Time				Classification	
			Speed	Position		Torque
	Setting Range	Setting Unit	Factory Setting	When Enabled		
	20 to 1000	1 ms	20	Immediately	Setup	

If the power interruption time is shorter than the set value in Pn509, the servomotor will continue operation. If it is longer than the set value, the servomotor's power will be turned OFF during the power interruption. The servomotor is turned ON when power supply to the main circuit recovers.

Set value for Pn509 \geq OFF time (t)

Set value for Pn509 $<$ OFF time (t)

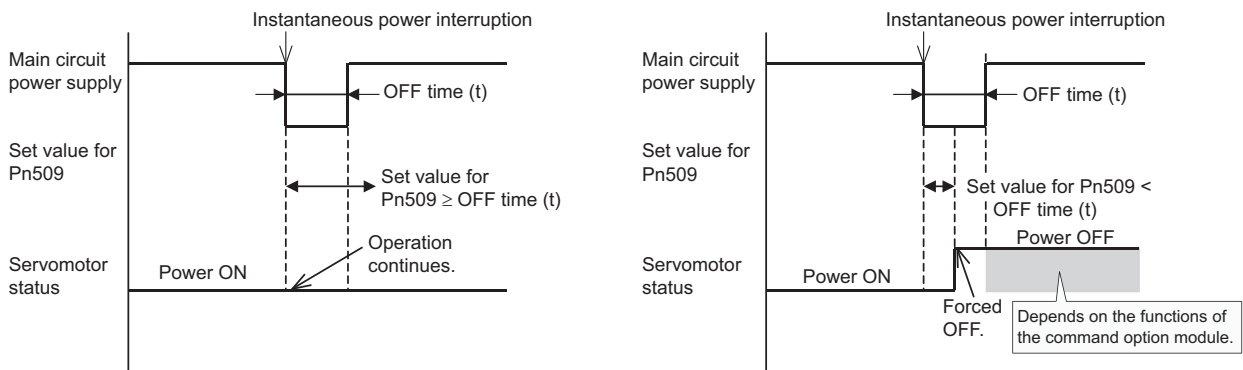

Note: If the instantaneous power interruption is longer than the set value of Pn509, the /S-RDY signal turns OFF.

IMPORTANT

- The holding time of the control power supply for the 200 V SERVOPACK is approximately 100 ms, but the time of the control power supply for the 100 V SERVOPACKs is approximately 65 ms. If the control power supply makes control impossible during an instantaneous power interruption, the same operation will be performed as for normally turning OFF the power supply, and the setting of the parameter will be ignored.
- The holding time of the main circuit power supply varies with the output of the SERVOPACK. If the load on the servomotor is large and an undervoltage alarm (A.410) occurs, the parameter will be ignored.
- The holding time of the control power supply (24 VDC) for the 400 V SERVOPACKs depends on the capability of the power supply (not included). Check the power supply before using the application.

If the uninterruptible power supplies are used for the control power supply and main circuit power supply, the SERVOPACK can withstand an instantaneous power interruption period in excess of 1000 ms.

4.2.10 SEMI-F47 Function (Torque Limit Function for Low Power Supply Voltage for Main Circuit)

The torque limit function detects a low voltage and limits the output current if the power supply voltage for the main circuit drops to a specified value or below.

This function complies with SEMI F47 standards for semiconductor production equipment.

Combining this function with the parameter for Instantaneous Power Cut Hold Time allows the servomotor to continue operating without stopping for an alarm or without recovery work even if the power supply voltage drops.



IMPORTANT

- The function is able to cope with instantaneous power interruptions in the voltage and time ranges stipulated in SEMI F47. An uninterruptible power supply (UPS) is required as a backup for instantaneous power interruptions that exceed these voltage and time ranges.
- The function is intended for voltage drops in the main circuit power supply. The following restrictions apply when it is used to provide an instantaneous power cut hold time in the control power supply. (There are no restrictions for the 200 V SERVOPACKs.)

<Control Power Supply Restrictions>

400 V SERVOPACKs: Provide the control power supply from a 24 VDC power supply that complies with SEMI F47 standards.

100 V SERVOPACKs: Provide the control power supply from an uninterruptible power supply (UPS).

- Set the host controller and SERVOPACK torque limit so that a torque reference that exceeds the specified acceleration will not be output when the power supply for the main circuit is restored.
- Do not limit the torque to values lower than the holding torque for the vertical axis.
- This function controls torque within the range of the SERVOPACK's capability when the power is cut. It is not intended for use under all load and operating conditions. Use the actual device to set parameters while confirming correct operation.
- Setting the Instantaneous Power Cut Hold Time (P.509) lengthens the amount of time from when the power supply is turned OFF until the power actually stops flowing to the motor. Send the servo OFF command to stop flowing the power to the motor.

(1) Execution Method

This function can be executed either with the host controller or independently with the SERVOPACK. Pn008.1 is used to specify whether the function is executed with the host controller or independently with the SERVOPACK.

■ Execution with Host Controller (Pn008=n.□□1□)

The host controller limits the torque in response to a low-voltage warning. The torque is no longer limited when the low-voltage warning is cleared.

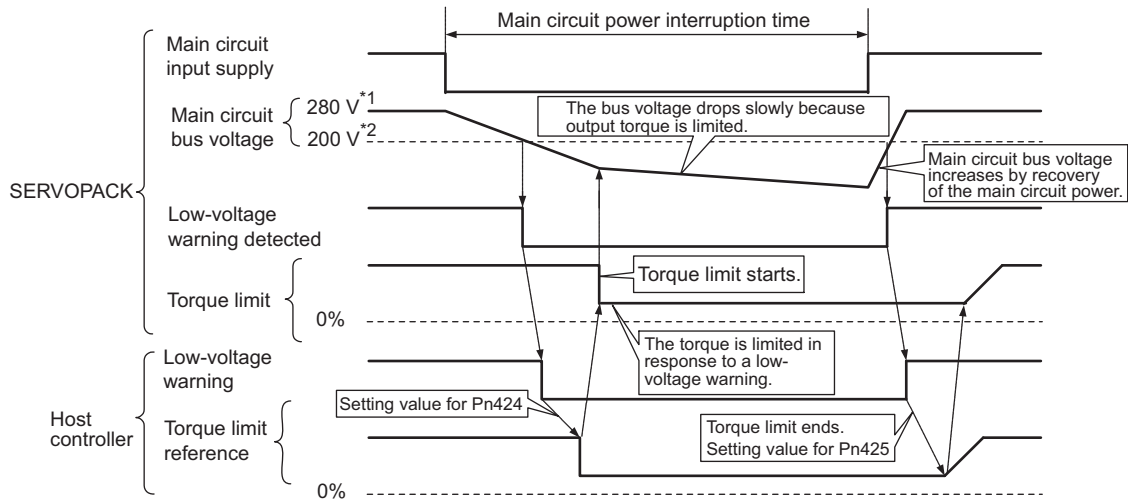

*1 560 V for 400 V power supply.
*2 400 V for 400 V power supply.

■ Execution Independently with SERVOPACK (Pn008=n.□□2□)

The torque is limited in the SERVOPACK in response to a low-voltage warning. The SERVOPACK stops limiting the torque in the set time (Pn425) when the low-voltage warning is cleared.

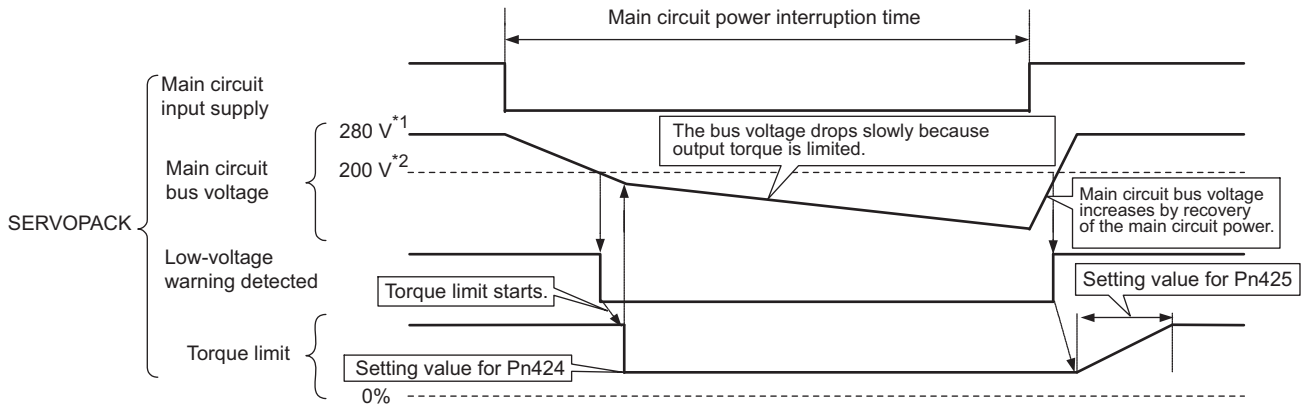

*1 560 V for 400 V power supply.
*2 400 V for 400 V power supply.

(2) Related Parameters

Parameter	Meaning	When Enabled	Classification
Pn008	n.□□0□	After restart	Setup
	A main circuit low voltage is not detected. [Factory setting]		
	n.□□1□		
n.□□2□	A main circuit low voltage is detected, and the host controller limits the torque.		
	A main circuit low voltage is detected, and the SERVOPACK independently limits the torque using Pn424 and Pn425.		

Pn424	Torque Limit at Main Circuit Voltage Drop Speed Position Torque				Classification
	Setting Range	Setting Unit	Factory Setting	When Enabled	
	0 to 100	1% *	50	Immediately	Setup
Pn425	Release Time for Torque Limit at Main Circuit Voltage Drop Speed Position Torque				Classification
	Setting Range	Setting Unit	Factory Setting	When Enabled	
	0 to 1000	1 ms	100	Immediately	Setup

* The setting unit is a percentage of the rated torque.

Pn509	Instantaneous Power Cut Hold Time Speed Position Torque				Classification
	Setting Range	Setting Unit	Factory Setting	When Enabled	
	20 to 1000	1 ms	20	Immediately	Setup

Note: When using SEMI F47 function, set 1000 ms.

4.2.11 Setting Motor Overload Detection Level

In this SERVOPACK, the detection timing of the overload warning (A.910) and overload (continuous overload) alarm (A.720) can be changed.

The overload characteristics and the detection level of the overload (instantaneous overload) alarm (A.710) cannot be changed.

(1) Changing Detection Timing of Overload Warning (A.910)

The overload warning level is set by default to 20% so that an overload warning is detected in 20% of the time required to detect an overload alarm. The time required to detect an overload warning can be changed by changing the setting of the overload warning level parameter (Pn52B). This protective function enables the overload warning output signal (/WARN) serve as a protective function and to be output at the best timing for your system.

The following graph shows an example of the detection of an overload warning when the overload warning level (Pn52B) is changed from 20% to 50%. An overload warning is detected in half of the time required to detect an overload alarm.

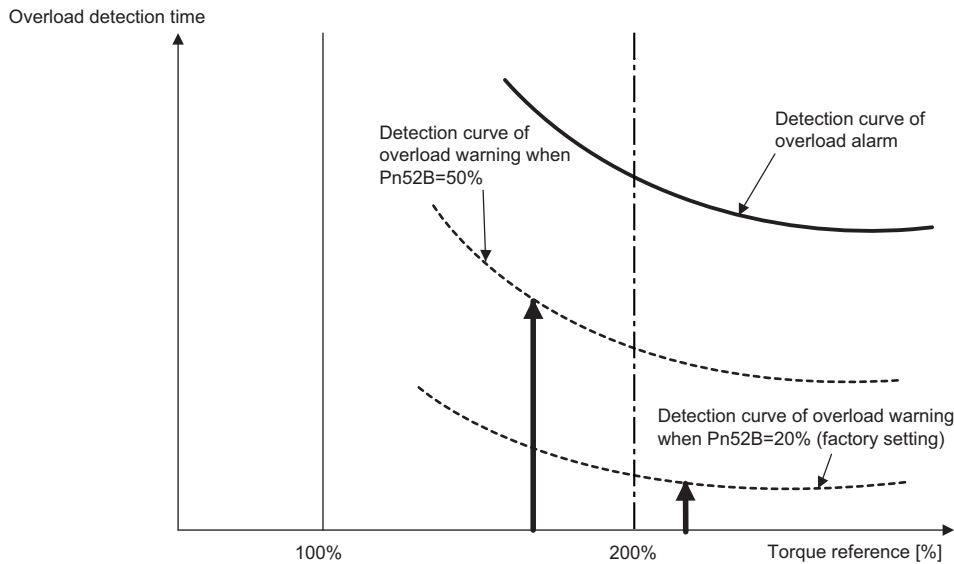

Note: For details, refer to ●Overload Characteristics listed in the section for the relevant servomotor in the ΣV Series Product Catalog (KAEP S800000 42).

Pn52B	Overload Warning Level				Classification	
	Setting Range	Setting Unit	Speed	Position		Torque
			Factory Setting	When Enabled		
	1 to 100	1%	20	Immediately		Setup

(2) Changing Detection Timing of Overload Alarm (A.720)

An overload alarm (continuous overload) can be detected earlier to protect the motor from overloading. The time required to detect an overload alarm can be shortened by using the derated motor base current obtained with the following equation. The detection level of the overload (instantaneous overload) alarm (A.710) cannot be changed.

$$\text{Motor base current} \times \text{Derating of base current at detecting overload of motor (Pn52C)} = \text{Derated motor base current}$$

Motor base current: Threshold value of motor current to start calculation for overload alarm
 Derating of base current at detecting overload of motor (Pn52C): Derating of motor base current

The following graph shows an example of the detection of an overload alarm when Pn52C is set to 50%. The calculation for the overload alarm of motors starts at 50% of the motor base current and then an overload alarm will be detected earlier.

Changing the setting of Pn52C will change the detection timing of the overload alarm, so the time required to detect the overload warning will also be changed.

As a guideline of motor heating conditions, the relationship between the heat sink sizes and deratings of base current is shown in a graph in:

Servomotor Heating Conditions in Rotary Servomotors General Instruction in Σ-V Series Product Catalog (KAEP S800000 42).

Set Pn52C to a value in accordance with the heat sink size and derating shown in the graph, so that an overload alarm can be detected at the best timing to protect the motor from overloading.

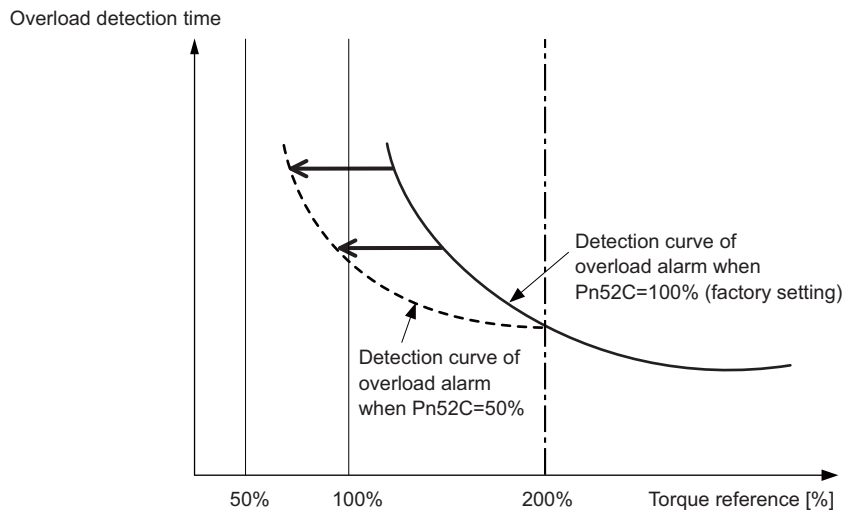

Note: For details, refer to ● *Overload Characteristics* listed in the section for the relevant servomotor in the Σ-V Series Product Catalog (KAEP S800000 42).

Pn52C	Derating of Base Current at Detecting Overload of Motor <input type="checkbox"/> Speed <input type="checkbox"/> Position <input type="checkbox"/> Torque <input type="checkbox"/>				Classification
	Setting Range	Setting Unit	Factory Setting	When Enabled	
	10 to 100	1%	100	After restart	Setup

4.3 Test Without Motor Function

The test without motor function is used to check the operation of the host and peripheral devices by simulating the operation of the motor in the SERVOPACK, i.e., without actually operating the motor. This function enables checking wiring and verifying the system and parameters when errors occur while debugging the system, thus shortening the time required for setup work and preventing damage to the equipment that may result from possible malfunctions. The operation of the motor can be checked during performing this function regardless of whether the motor is actually connected or not.

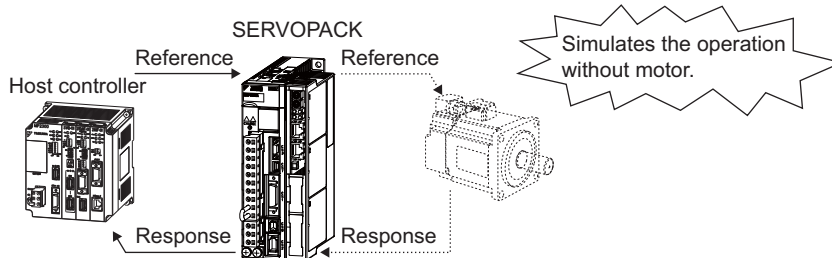

4.3.1 Related Parameters

The following parameters are used for the test without motor.

Parameter	Meaning	When Enabled	Classification
Pn00C	n.□□□0	After restart	Setup
	n.□□□1		
	n.□□0□		
	n.□□1□		
	n.□0□□		
	n.□1□□		

* Absolute encoder is only for rotational servomotors. External encoders such as encoders for fully-closed loop control are used as incremental encoders regardless of the setting of Pn00C.2.

4.3.2 Limitations

The following functions cannot be used during the test without motor.

- Regeneration and dynamic brake operation
- Brake output signal (The brake output signal can be checked with the I/O signal monitor function of the SigmaWin+.)
- Items marked with “X” in the following utility function table.

Fn No.	Contents	Can be used or not	
		Motor not connected	Motor connected
Fn000	Alarm history display	○	○
Fn002	JOG operation	○	○
Fn003	Origin search	○	○
Fn004	Program JOG operation	○	○
Fn005	Initializing parameter settings	○	○
Fn006	Clearing alarm history	○	○
Fn008	Absolute encoder multi-turn reset and encoder alarm reset	×	○
Fn00C	Offset adjustment of analog monitor output	○	○
Fn00D	Gain adjustment of analog monitor output	○	○
Fn00E	Automatic offset-signal adjustment of motor current detection signal	×	○
Fn00F	Manual offset-signal adjustment of motor current detection signal	×	○
Fn010	Write prohibited setting	○	○
Fn011	Servomotor model display	○	○
Fn012	Software version display	○	○
Fn013	Multi-turn limit value setting change when a multi-turn limit disagreement alarm occurs	×	○
Fn014	Resetting configuration error of option module	○	○
Fn01B	Vibration detection level initialization	×	×
Fn01E	Display of SERVOPACK and servomotor ID	○	○
Fn01F	Display of servomotor ID in feedback option	○	○
Fn020	Origin setting	×	○
Fn030	Software reset	○	○
Fn200	Tuning-less level setting	×	×
Fn201	Advanced autotuning	×	×
Fn202	Advanced autotuning by reference	×	×
Fn203	One-parameter tuning	×	×
Fn204	Anti-resonance control adjustment function	×	×
Fn205	Vibration suppression function	×	×
Fn206	EasyFFT	×	×
Fn207	Online vibration monitor	×	×

○ : can be used

× : cannot be used

4.3.3 Digital Operator Display during Testing without Motor

The mark (*) is displayed before status display to indicate the test without motor operation is in progress.

* B B	- P R M / M O N -
U n 0 0 0 =	0 0 0 0 0
U n 0 0 2 =	0 0 0 0 0
U n 0 0 8 =	0 0 0 0 0 0 0 0 0 0
U n 0 0 D =	0 0 0 0 0 0 0 0 0 0

(Example: Test without motor in progress)

Display	Status
*RUN	Power is supplied to the motor.
*BB	Power to the motor is OFF.
*PT NT	Forward or reverse run is prohibited.
*P-OT	Running in the forward direction is prohibited.
*N-OT	Running in the reverse direction is prohibited.
*HBB	In hard-wire base block (safety) state.

Note: The test without motor status is not displayed during alarm occurs (A.□□□).

4.4 Limiting Torque

The SERVOPACK provides the following three methods for limiting output torque to protect the machine.

Limiting Method	Description	Reference Section
Internal torque limit	Always limits torque by setting the parameter.	4.4.1
External torque limit	Limits torque by input signal from the host controller.	4.4.2
Torque limit with command option module	Limits torque by inputting a desired torque limit command to the command option module from the host controller.	Refer to the manual of the command option module to be connected.

4.4.1 Internal Torque Limit

This function always limits maximum output torque by setting values of following parameters.

Pn402	Forward Torque Limit Speed Position Torque				Classification
	Setting Range	Setting Unit	Factory Setting	When Enabled	
	0 to 800	1%	800	Immediately	Setup
Pn403	Reverse Torque Limit Speed Position Torque				Classification
	Setting Range	Setting Unit	Factory Setting	When Enabled	
	0 to 800	1%	800	Immediately	Setup

The setting unit is a percentage of the rated torque.

- Note 1. Too small a torque limit setting will result in insufficient torque during acceleration and deceleration.
 2. The maximum torque of the servomotor is used whenever the value exceeds the maximum torque is set.

Waveform of Torque

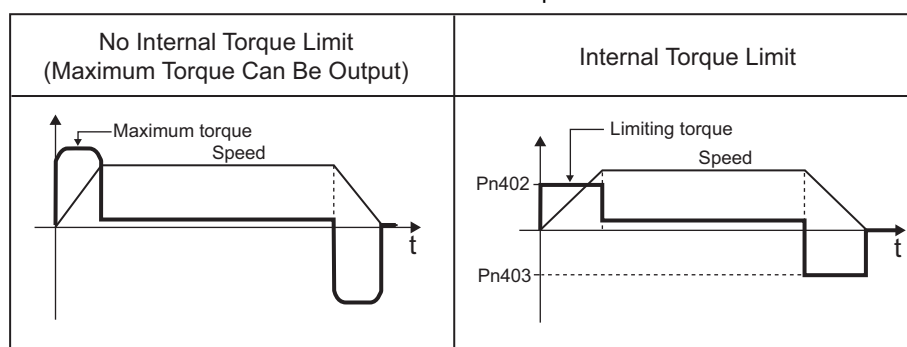

4.4.2 External Torque Limit

Use this function to limit torque by inputting a signal from the host controller at a specific times during machine operation, such as forced stop or hold operations for robot workpieces.

(1) Input Signals

Type	Signal Name	Connector Pin Number	Setting	Meaning	Limit value
Input	/P-CL	Must be allocated	ON	Forward external torque limit ON	The value set in Pn402 or Pn404 (whichever is smaller)
			OFF	Forward external torque limit OFF	Pn402
Input	/N-CL	Must be allocated	ON	Reverse external torque limit ON	The value set in Pn403 or Pn405 (whichever is smaller)
			OFF	Reverse external torque limit OFF	Pn403

Note: When using external torque limit, make sure that there are no other signals allocated to the same terminals as /P-CL and /N-CL. When multiple signals are allocated to the same terminal, the signals are handled with OR logic, which affects the ON/OFF state of the other signals. Refer to 3.3.1 *Input Signal Allocations*.

(2) Related Parameters

Set the following parameters for external torque limit.

Pn402	Forward Torque Limit Speed Position Torque				Classification
	Setting Range	Setting Unit	Factory Setting	When Enabled	
	0 to 800	1%	800	Immediately	Setup
Pn403	Reverse Torque Limit Speed Position Torque				Classification
	Setting Range	Setting Unit	Factory Setting	When Enabled	
	0 to 800	1%	800	Immediately	Setup
Pn404	Forward External Torque Limit Speed Position Torque				Classification
	Setting Range	Setting Unit	Factory Setting	When Enabled	
	0 to 800	1%	100	Immediately	Setup
Pn405	Reverse External Torque Limit Speed Position Torque				Classification
	Setting Range	Setting Unit	Factory Setting	When Enabled	
	0 to 800	1%	100	Immediately	Setup

The setting unit is a percentage of the rated torque.

Note: If the settings of Pn402, Pn403, Pn404, and Pn405 are too low, the torque may be insufficient for acceleration or deceleration of the servomotor.

(3) Changes in Output Torque during External Torque Limiting

Changes in output torque when external torque limit is set to 800% are shown with the waveform of SigmaWin+.

In this example, the servomotor rotation direction is Pn000.0 = 0 (CCW = forward).

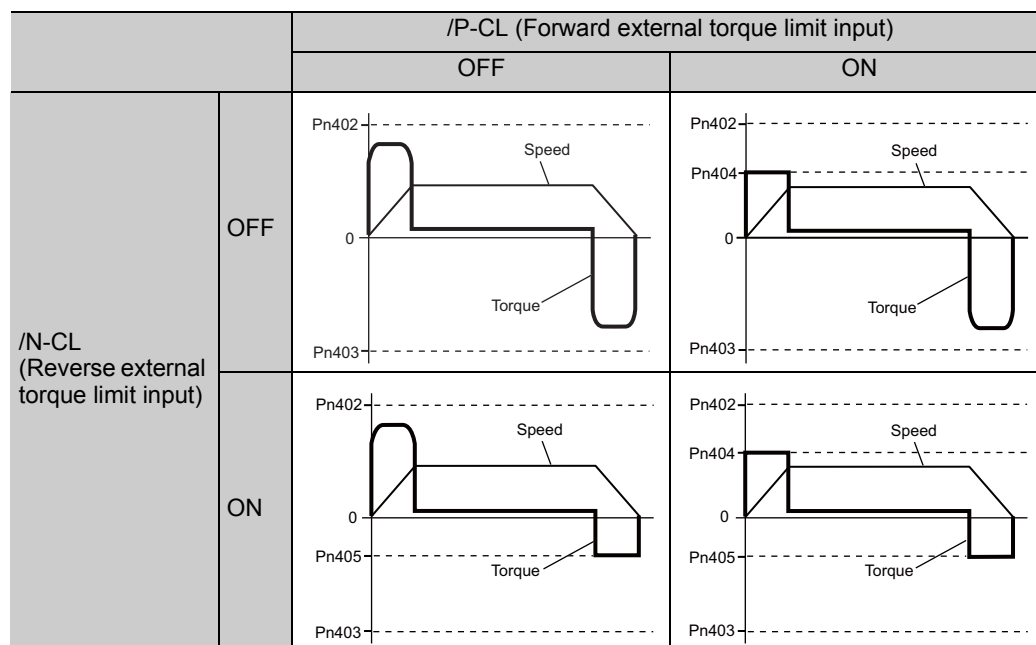

4.4.3 Checking Output Torque Limiting during Operation

The following signal can be output to indicate that the servomotor output torque is being limited.

Type	Signal Name	Connector Pin Number	Setting	Meaning
Output	/CLT	Must be allocated	ON (close)	Servomotor output torque is being limited.
			OFF (open)	Torque is not being limited.

Note: Use parameter Pn50F.0 to allocate the /CLT signal for use. For details, refer to 3.3.2 *Output Signal Allocation*.

4.5 Absolute Encoders

If using an absolute encoder, a system to detect the absolute position can be designed for use with the host controller. As a result, an operation can be performed without a zero point return operation immediately after the power is turned ON.

A battery case is required to save position data in the absolute encoder.
The battery is attached to the battery case of the encoder cable.

If an encoder cable with a battery case is not used, install a battery to the host controller.

 PROHIBITED
<ul style="list-style-type: none"> • Do not install batteries in both the host controller and battery case. It is dangerous because that sets up a loop circuit between the batteries.

Note: No battery unit is required, because direct-drive servomotors with the standard specifications have a single-turn absolute encoder. Detailed settings are not required for the multi-turn limit or for an absolute encoder.

Set Pn002.2 to 0 (factory setting) to use the absolute encoder.

Parameter	Meaning	When Enabled	Classification
Pn002	n.□0□□ [Factory setting]	Uses the absolute encoder as an absolute encoder.	After restart Setup
	n.□1□□	Uses the absolute encoder as an incremental encoder.	

A battery is not required when using the absolute encoder as an incremental encoder.

 IMPORTANT	<p>The output range of the rotational serial data for the Σ-V absolute position detecting system is different from that of earlier systems for 12-bit and 15-bit encoders. As a result, the infinite-length positioning system of the Σ Series must be changed for use with products in the Σ-V Series. Be sure to make the following system modification.</p>												
<table border="1" style="width: 100%; border-collapse: collapse;"> <thead> <tr> <th style="width: 20%;">Servomotor Series</th> <th style="width: 15%;">Resolution</th> <th style="width: 20%;">Output Range of Rotational Serial Data</th> <th style="width: 45%;">Action when Limit Is Exceeded</th> </tr> </thead> <tbody> <tr> <td style="vertical-align: top;"> Σ Series SGD SGDA SGDB </td> <td style="vertical-align: top;"> 12-bit 15-bit </td> <td style="vertical-align: top;"> -99999 to + 99999 </td> <td style="vertical-align: top;"> <ul style="list-style-type: none"> • When the upper limit (+99999) is exceeded in the forward direction, the rotational serial data will be 0. • When the lower limit (-99999) is exceeded in the reverse direction, the rotational serial data will be 0. </td> </tr> <tr> <td style="vertical-align: top;"> Σ-II, Σ-III, Σ-V Series SGDM SGDH SGDS SGDV </td> <td style="vertical-align: top;"> 17-bit 20-bit </td> <td style="vertical-align: top;"> -32768 to + 32767 </td> <td style="vertical-align: top;"> <ul style="list-style-type: none"> • When the upper limit (+32767) is exceeded in the forward direction, the rotational serial data will be -32768.* • When the lower limit (-32768) is exceeded in the reverse direction, the rotational serial data will be +32767.* </td> </tr> </tbody> </table>	Servomotor Series	Resolution	Output Range of Rotational Serial Data	Action when Limit Is Exceeded	Σ Series SGD SGDA SGDB	12-bit 15-bit	-99999 to + 99999	<ul style="list-style-type: none"> • When the upper limit (+99999) is exceeded in the forward direction, the rotational serial data will be 0. • When the lower limit (-99999) is exceeded in the reverse direction, the rotational serial data will be 0. 	Σ -II, Σ -III, Σ -V Series SGDM SGDH SGDS SGDV	17-bit 20-bit	-32768 to + 32767	<ul style="list-style-type: none"> • When the upper limit (+32767) is exceeded in the forward direction, the rotational serial data will be -32768.* • When the lower limit (-32768) is exceeded in the reverse direction, the rotational serial data will be +32767.* 	<p>* The action differs when the multiturn limit setting (Pn205) is changed. Refer to <i>4.5.6 Multiturn Limit Setting</i>.</p>
Servomotor Series	Resolution	Output Range of Rotational Serial Data	Action when Limit Is Exceeded										
Σ Series SGD SGDA SGDB	12-bit 15-bit	-99999 to + 99999	<ul style="list-style-type: none"> • When the upper limit (+99999) is exceeded in the forward direction, the rotational serial data will be 0. • When the lower limit (-99999) is exceeded in the reverse direction, the rotational serial data will be 0. 										
Σ -II, Σ -III, Σ -V Series SGDM SGDH SGDS SGDV	17-bit 20-bit	-32768 to + 32767	<ul style="list-style-type: none"> • When the upper limit (+32767) is exceeded in the forward direction, the rotational serial data will be -32768.* • When the lower limit (-32768) is exceeded in the reverse direction, the rotational serial data will be +32767.* 										

4.5.1 Connecting the Absolute Encoder

The following diagram shows the connection between a servomotor with an absolute encoder, the SERVOPACK, and the host controller.

(1) Using an Encoder Cable with a Battery Case

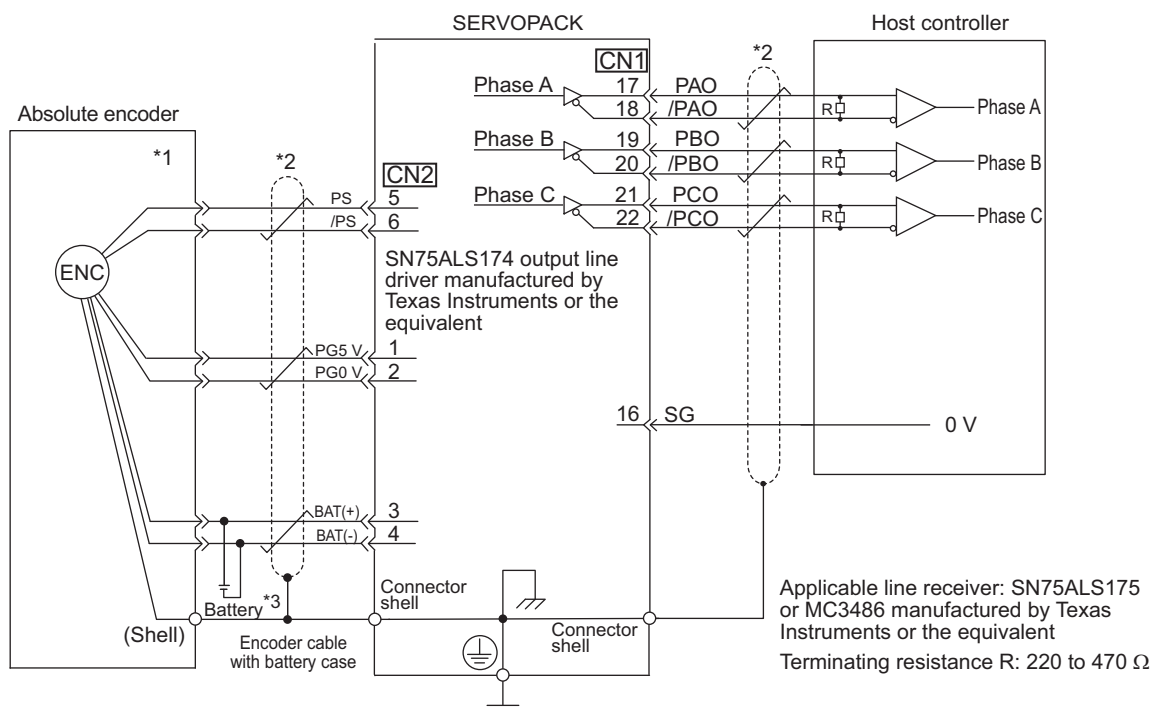

*1. The absolute encoder pin numbers for the connector wiring depend on the servomotors.

*2.  : represents shielded twisted-pair wires.

*3. When using an absolute encoder, provide power by installing an encoder cable with a JUSP-BA01-E Battery Case or install a battery on the host controller.

(2) Installing the Battery in the Host Controller

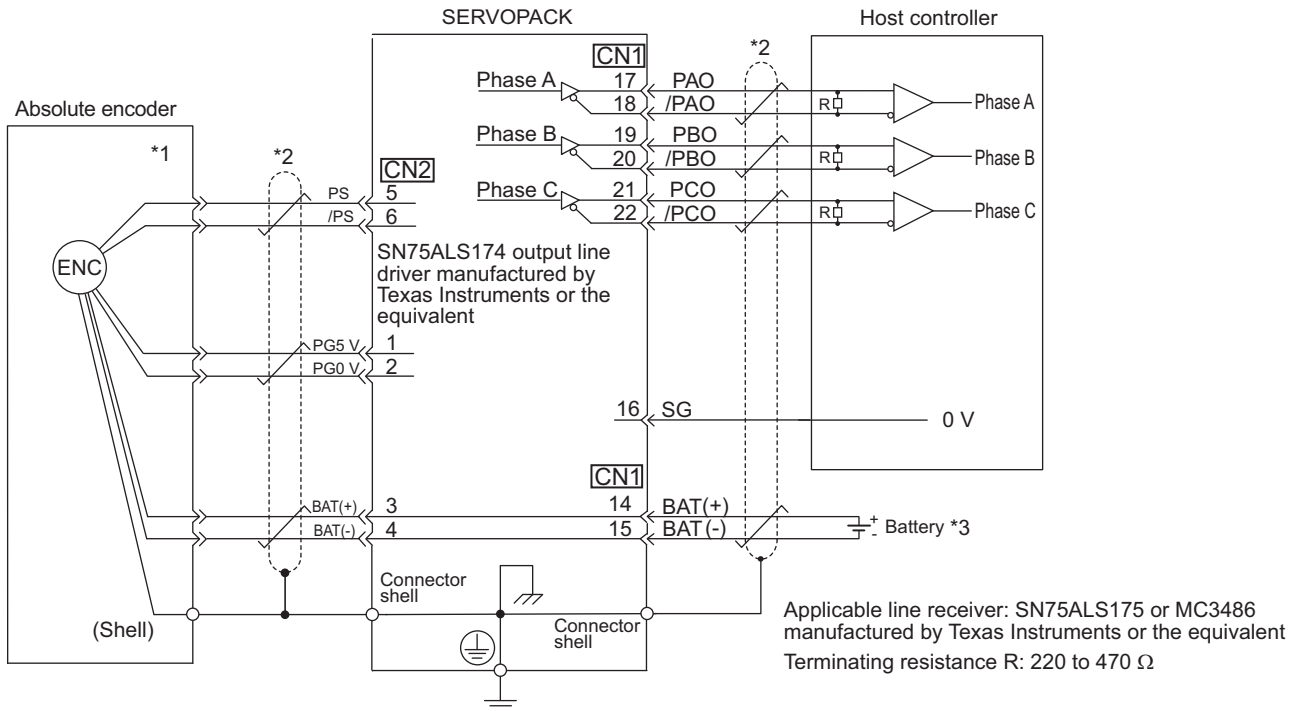

*1. The absolute encoder pin numbers for the connector wiring depend on the servomotors.

*2.  : represents shielded twisted-pair wires.

*3. When using an absolute encoder, provide power by installing an encoder cable with a JUSP-BA01-E Battery Case or install a battery on the host controller.

4.5.2 Absolute Data Request (Sensor ON Command)

The Sensor ON command must be sent to obtain absolute data as an output from the SERVOPACK.

The Sensor ON command is sent at the following timing.

Note: Command sending method differs in accordance with the connected command option module.
For details, refer to the manual for the command option module that is connected.

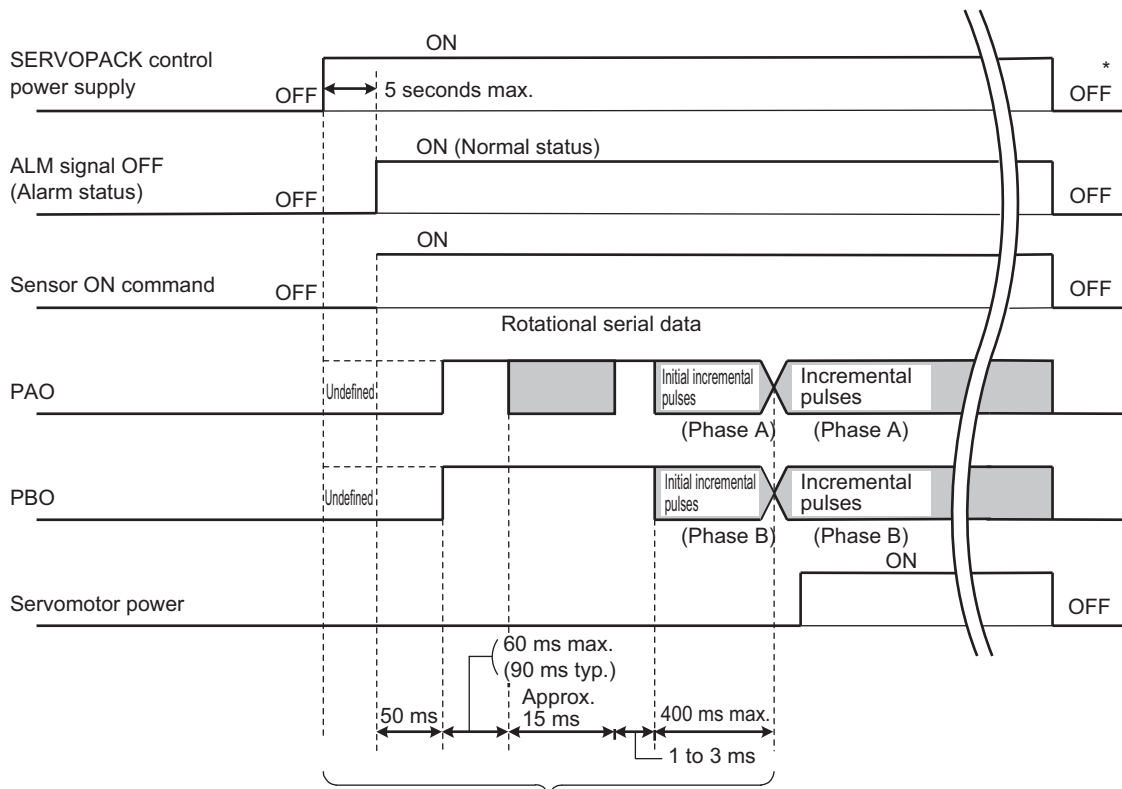

The servomotor will not be turned ON even if the Sensor ON command is received during this interval.

* Turn OFF the Sensor ON command to turn OFF the control power supply.

4.5.3 Battery Replacement

If the battery voltage drops to approximately 2.7 V, an absolute encoder battery error (A.830) or absolute encoder battery warning (A.930) will be displayed.

If an alarm or warning is displayed, replace the battery using the following procedure.

Use Pn008 to set either an alarm (A.830) or a warning (A.930).

Parameter	Meaning	When Enabled	Classification
Pn008	n.□□□0	After restart	Setup
	n.□□□1		

- If Pn008.0 is set to 0, an ALM signal is sent for a maximum of 5 seconds, and then the battery voltage is checked for 4 seconds when the power is turned ON.

Note: After those initial 4 second, no alarm will be displayed even if the battery voltage drops to approximately 2.7 V.

- If Pn008.0 is set to 1, the battery voltage will constantly be monitored.

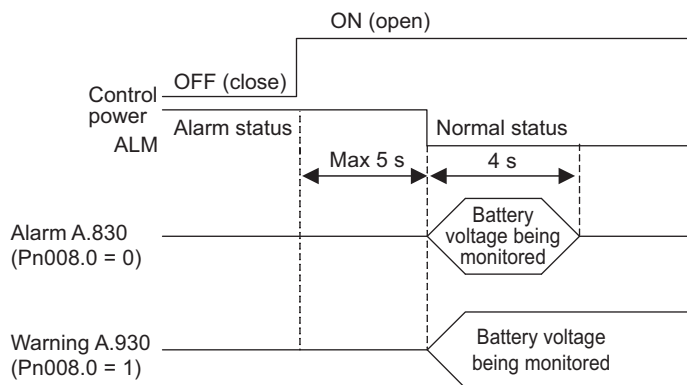

(1) Battery Replacement Procedure

■ Using an Encoder Cable with a Battery Case

1. Turn ON only the SERVOPACK control power supply.
2. Open the battery case cover. (Example: cable with battery and connectors at both ends)

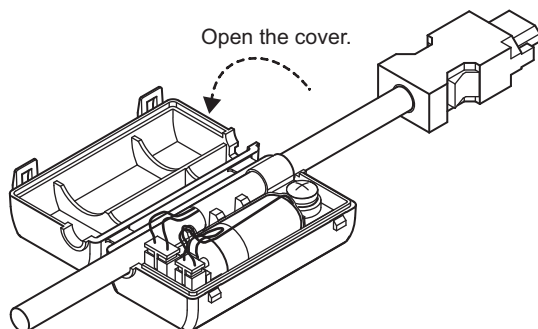

3. Remove the old battery and mount the battery (JZSP-BA01) as shown below.

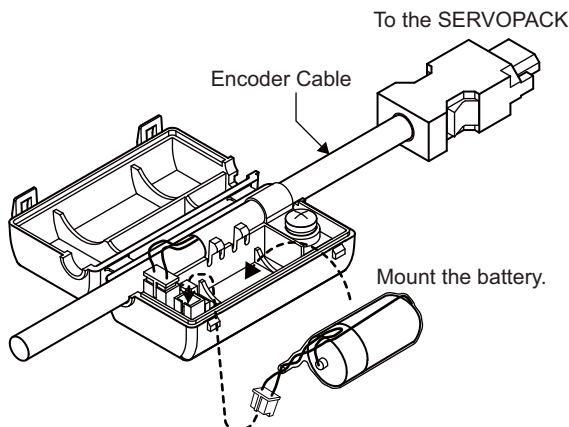

4. Close the battery case cover.

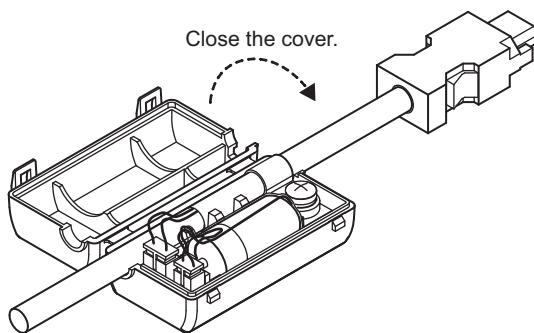

5. After replacing the battery, turn OFF the SERVOPACK power to cancel the absolute encoder battery error (A.830).
6. Turn ON the SERVOPACK power back again.
7. Check that the error display is cancelled and it operates without any problems.



IMPORTANT

Make sure the SERVOPACK's control power is on when replacing the battery or disconnecting the encoder cable.
If the power is turned off, the data of the absolute encoder will be deleted.

■ Installing a Battery in the Host Controller

1. Turn ON the control power supply of the SERVOPACK only.
2. Remove the old battery and mount the new battery.
3. After replacing the battery, turn OFF the control power supply to clear the absolute encoder battery error alarm (A.830).
4. Turn ON the control power supply again.
5. Check that the alarm display has been cleared and that the SERVOPACK operates normally.

4.5.4 Absolute Encoder Setup (Initialization)

CAUTION

- The rotational data will be a value between -2 and +2 rotations when the absolute encoder setup is executed. The reference position of the machine system will change. Set the reference position of the host controller to the position after setup. If the machine is started without adjusting the position of the host controller, unexpected operation may cause injury or damage to the machine. Take sufficient care when operating the machine.

Setting up the absolute encoder is necessary in the following cases.

- When starting the machine for the first time
- When an encoder backup error (A.810) is generated
- When an encoder checksum error (A.820) is generated
- To set the absolute encoder rotational serial data to 0













Setup the absolute encoder with Fn008.

(1) Precautions on Setup

- The write prohibited setting parameter (Fn010) must be set to Write permitted (P.0000).
- Setup the encoder when the servomotor power is OFF.
- The encoder backup error (A.810) and the encoder checksum error (A.820) cannot be reset by using the SERVOPACK alarm reset. Be sure to perform setup using Fn008.
- Any other alarms that monitor the inside of the encoder (A.8□□) should be canceled by turning OFF the power, then canceling the alarm.

(2) Procedure for Setup

Follow the steps below to setup the absolute encoder.

Step	Display after Operation	Keys	Description
1	<pre> BB —FUNCTION— Fn006: AlmHist Clr Fn008: Mturn Clr Fn009: Ref Adj Fn00A: Vel Adj </pre>	  	Press the  key and select Fn008.
2	<pre> BB Multiturn Clear PGCL1 </pre>		Press the  key to view the execution display of Fn008. Note: If the display is not switched and “NO_OP” is displayed in the status display, the Write Prohibited Setting (Fn010 = 0001) is set. Check the status and reset.
3	<pre> BB Multiturn Clear PGCL5 </pre>	 	Keep pressing the  Key until “PGCL1” is changed to “PGCL5.”
4	<pre> DONE Multiturn Clear PGCL5 </pre>		Press the  Key to setup the absolute encoder. After completing the setup, “BB” in the status display changes to “DONE.”
5	<pre> BB —FUNCTION— Fn006: AlmHist Clr Fn008: Mturn Clr Fn009: Ref Adj Fn00A: Vel Adj </pre>		Press the  Key to return to the display of the procedure 1.
6	Turn OFF the power and then turn it ON again to make the setting valid.		

4.5.5 Absolute Encoder Reception Sequence

The sequence in which the SERVOPACK receives outputs from the absolute encoder and transmits them to host controller is shown below.

(1) Outline of Absolute Signals

The serial data, pulses, etc., of the absolute encoder that are output from the SERVOPACK are output from the PAO, PBO, and PCO signals as shown below.

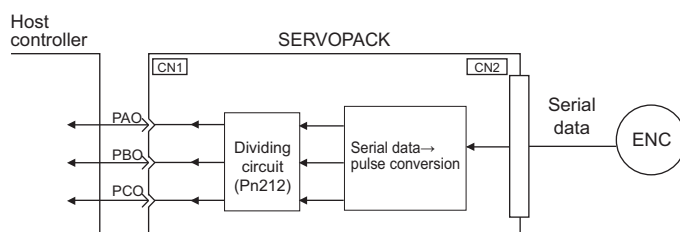

Signal Name	Status	Contents
PAO	At initialization	Rotational serial data Initial incremental pulses
	Normal time	Incremental pulses
PBO	At initialization	Initial incremental pulses
	Normal time	Incremental pulses
PCO	Always	Origin pulses

■ Phase-C Output Specifications

The pulse width of phase C (origin pulse) changes depending on the encoder output pulse (Pn212), becoming the same width as phase A.

The output timing is one of the following.

- Synchronized with the rising edge of phase A
- Synchronized with the falling edge of phase A
- Synchronized with the rising edge of phase B
- Synchronized with the falling edge of phase B

Note: When host controller receives the data of absolute encoder, do not perform counter reset using the output of PCO signal.

(2) Absolute Data Reception Sequence

1. Send the sensor ON command from the host controller.
2. After 100 ms, set the system to serial data reception-waiting-state. Clear the incremental pulse up/down counter to zero.
3. Receive eight characters of rotational serial data.
4. The system enters a normal incremental operation state about 400 ms after the last rotational serial data is received.

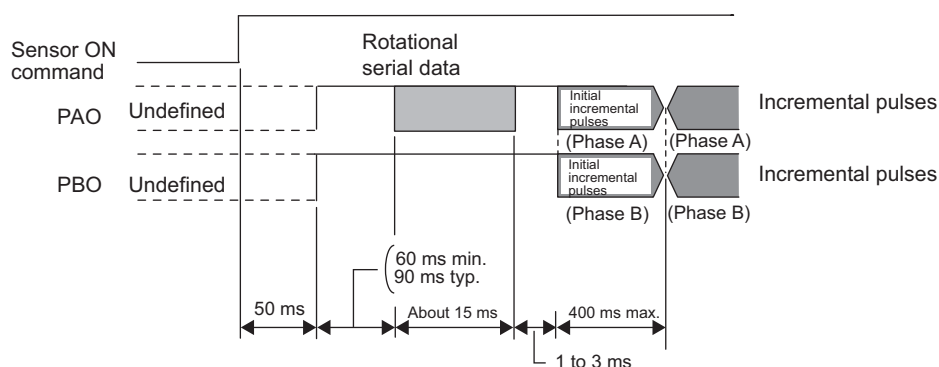

Note: The output pulses are phase-B advanced if the servomotor is turning forward regardless of the setting in Pn000.0.

Rotational serial data:

Indicates how many turns the motor shaft has made from the reference position (position at setup).

Initial incremental pulses:

Initial incremental pulses which provide absolute data are the number of pulses required to rotate the motor shaft from the servomotor origin to the present position.

Just as with normal incremental pulses, these pulses are divided by the dividing circuit inside the SERVO-PACK and then output.

The initial incremental pulse speed depends on the setting of the encoder output pulses (Pn212). Use the following formula to obtain the initial incremental pulse speed.

Setting of the Encoder Output Pulses (Pn212)	Formula of the Initial Incremental Pulse Speed
16 to 16384	$\frac{680 \times Pn212}{16384}$ [kpps]
16386 to 32768	$\frac{680 \times Pn212}{32768}$ [kpps]
32772 to 65536	$\frac{680 \times Pn212}{65536}$ [kpps]
65544 to 131072	$\frac{680 \times Pn212}{131072}$ [kpps]
131088 to 262144	$\frac{680 \times Pn212}{262144}$ [kpps]

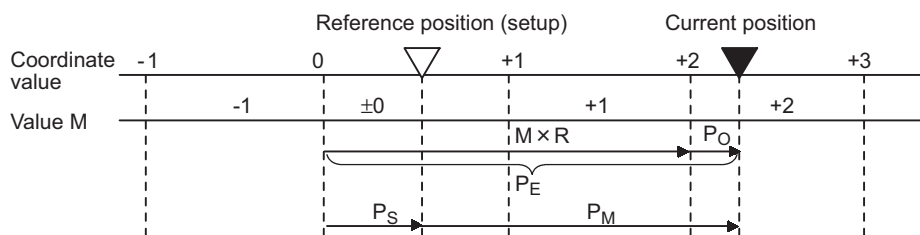

Final absolute data P_M is calculated by following formula.

$$P_E = M \times R + P_O$$

$$P_S = M_S \times R + P_S'$$

$$P_M = P_E - P_S$$

Signal	Meaning
P _E	Current value read by encoder
M	Rotational data
P _O	Number of initial incremental pulses
P _S	Absolute data read at setup (This is saved and controlled by the host controller.)
M _S	Rotational data read at setup
P _S '	Initial incremental pulses read at setup
P _M	Current value required for the user's system.
R	Number of pulses per encoder revolution (pulse count after dividing, value of Pn212)

Note: The following formula applies in reverse mode. (Pn000.0 = 1)

$$P_E = -M \times R + P_O$$

$$P_S = M_S \times R + P_S'$$

$$P_M = P_E - P_S$$

(3) Rotational Serial Data Specifications and Initial Incremental Pulses

■ Rotational Serial Data Specifications

The rotational serial data is output from PAO signal.

Data Transfer Method	Start-stop Synchronization (ASYNC)
Baud rate	9600 bps
Start bits	1 bit
Stop bits	1 bit
Parity	Even
Character code	ASCII 7-bit code
Data format	8 characters, as shown below.

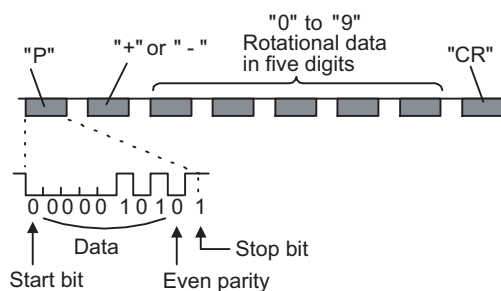

Note:

- Data is "P+00000" (CR) or "P-00000" (CR) when the number of revolutions is zero.
- The allowable range of the rotational serial data is "-32768" to "+32767." When the value is outside the allowable range, the data changes from "+32767" to "-32678" or from "-32678" to "+32767." When changing the multiturn limit, the range changes. For details, refer to 4.5.6 Multiturn Limit Setting.

■ Initial Incremental Pulses

The initial incremental pulses are output after division inside the SERVOPACK in the same way as for normal incremental pulses. Refer to 4.2.5 Encoder Output Pulses for details.

(4) Transferring Alarm Contents

If an absolute encoder is used, the contents of alarms detected by the SERVOPACK can be transmitted in serial data to the host controller from the PAO output when the sensor ON command is changed from ON to OFF.

Note: Sensor ON command cannot be turned OFF while the servomotor power is ON.

An example of alarm contents output is shown below.

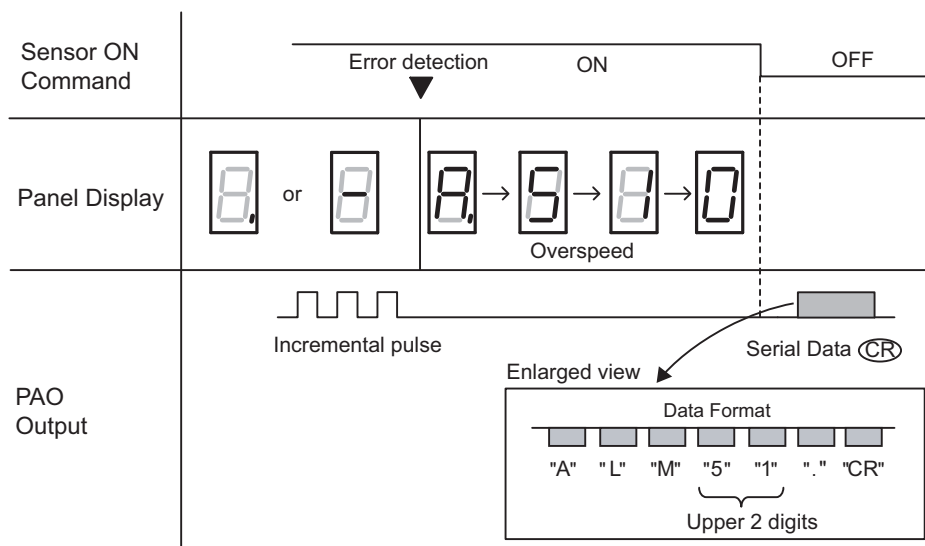

4.5.6 Multiturn Limit Setting

The multiturn limit setting is used in position control applications for a turntable or other rotating device. For example, consider a machine that moves the turntable in the following diagram in only one direction.

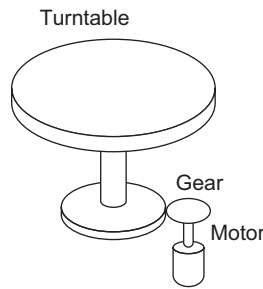

Because the turntable moves in only one direction, the upper limit for revolutions that can be counted by an absolute encoder will eventually be exceeded. The multiturn limit setting is used in cases like this to prevent fractions from being produced by the integral ratio of the motor revolutions and turntable revolutions.

For a machine with a gear ratio of n:m, as shown above, the value of m minus 1 will be the setting for the multiturn limit setting (Pn205).

Multiturn limit setting (Pn205) = m-1

The case in which the relationship between the turntable revolutions and motor revolutions is m = 100 and n = 3 is shown in the following graph.

Pn205 is set to 99.

$$Pn205 = 100 - 1 = 99$$

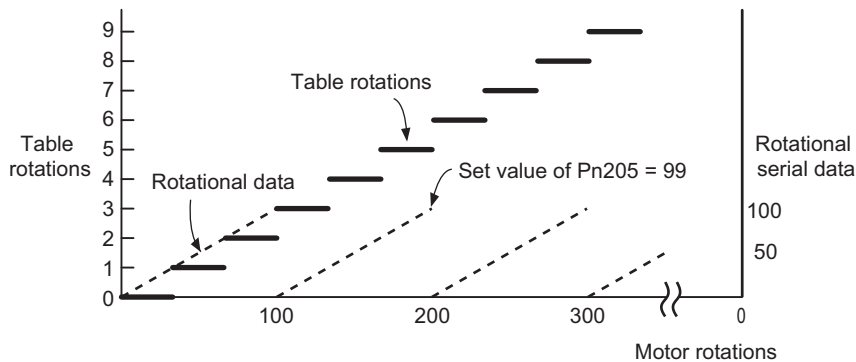

Pn205	Multiturn Limit				Classification
	Setting Range	Setting Unit	Factory Setting	When Enabled	
	0 to 65535	1 Rev	65535	After restart	

Note: This parameter is valid when the absolute encoder is used.

The range of the data will vary when this parameter is set to anything other than the factory setting.

1. When the motor rotates in the reverse direction with the rotational data at 0, the rotational data will change to the setting of Pn205.
2. When the motor rotates in the forward direction with the rotational data at the Pn205 setting, the rotational data will change to 0.

Set the value, the desired rotational amount -1, to Pn205.

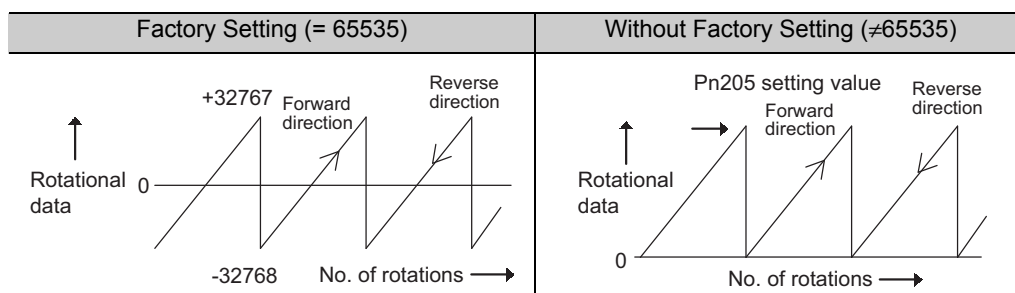

Note:

A direct-drive servomotor with the standard specifications has a single-turn absolute encoder mounted. It is possible to directly connect the servomotor and the load, and so absolute values can be created at the load by using only the angle of the motor shaft even when constructing an absolute value detection system. Therefore, encoder multiturn data is not required.

4.5.7 Multi-turn Limit Disagreement (A.CC0)

When the multiturn limit set value is changed with parameter Pn205, an alarm A.CC0 (multi-turn limit disagreement) will be displayed because the value differs from that of the encoder.

Alarm Display	Alarm Name	Alarm Code Output	Meaning
A.CC0	Multi-turn Limit Disagreement	OFF (H)	Different multi-turn limits have been set in the encoder and SERVOPACK.

If this alarm is displayed, perform the operation described below and change the multi-turn limit value in the encoder to the value set in Pn205

Step	Display after Operation	Keys	Operation
1	A.CC0 -FUNCTION- Fn012:Soft Ver Fn013:MturnLmSet Fn014:Opt Init Fn01B:ViblvI Init	MODE/SET ▲ ▼	Press the Key to select the utility function. And press the or Key to select the Fn013.
2	A.CC0 Multiturn Limit Set Start :[DATA] Return:[SET]	DATA	Press the Key to view the execution display of Fn013. Note: If the display is not switched and "NO-OP" is displayed in the status display, the Write Prohibited Setting (Fn010 = 0001) is set. Check the setting and reset.
3	A.CC0 Multiturn Limit Set Start :[DATA] Return:[SET]	DATA	Press the Key to set the multiturn limit value. When the setting is completed, the status display shows "DONE" for one second. The status display then returns to show "A.CC0" again. Note: If the Key is pressed instead of the Key, the multiturn limit value will not be reset.
4	A.CC0 -FUNCTION- Fn012:Soft Ver Fn013:MturnLmSet Fn014:Opt Init Fn01B:ViblvI Init		Press the Key to return to the display the procedure 1.
5	To enable the change in the setting, turn the power OFF and ON again.		

4.6 Safety Function

The safety function is incorporated in the SERVOPACK to reduce the risk associated with the machine by protecting workers from injury and by securing safe machine operation. Especially when working in hazardous areas inside the safeguard, as for machine maintenance, it can be used to avoid adverse machine movement.

4.6.1 Hard Wire Base Block (HWBB) Function

The hard wire base block function (hereinafter referred to as HWBB function) is a safety function designed to shut off the motor current by using the hardwired circuits: Each circuit for two channel input signals blocks the run signal to turn off the power module, and the motor current is shut off. (Refer to the diagram below.)

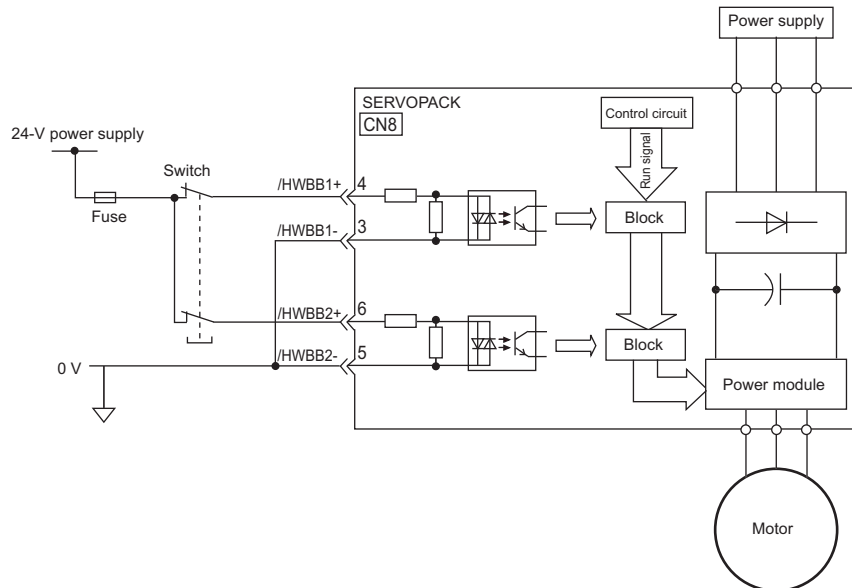

Note: For safety function signal connections, the input signal is the 0V common and the output signal is the source output. This is opposite to other signals described in this manual. To avoid confusion, the ON and OFF status of signals for safety functions are defined as follows:

ON: The state in which the relay contacts are closed or the transistor is ON and current flows into the signal line.

OFF: The state in which the relay contacts are open or the transistor is OFF and no current flows into the signal line.

(1) Risk Assessment

When using the HWBB function, be sure to perform a risk assessment of the servo system in advance. Make sure that the safety level of the standards is met. For details about the standards, refer to *Applicable Standards* at the front of this manual.

Note: To meet the performance level d (PLd) in EN ISO 13849-1, the EDM signal must be monitored by a host controller. If the EDM signal is not monitored by a host controller, the system only qualifies for the performance level c (PLc).

The following risks can be estimated even if the HWBB function is used. These risks must be included in the risk assessment.

- The motor will rotate in an application where external force is applied to the motor (for example, gravity on the vertical axis). Take measures to secure the motor, such as installing a mechanical brake.
- The motor may move within the electric angle of 180 degrees in case of the power module failure, etc. Make sure to take the proper measures to ensure safety when the motor starts to move. The rotation angle depends on the motor type. The maximum rotation angle is given below.
 - Rotational motor: 1/6 rotation max. (rotation angle at the motor shaft)
 - Direct drive motor: 1/20 rotation max. (rotation angle at the motor shaft)
- The HWBB function does not shut off the power to the SERVOPACK or electrically isolate it. Take measures to shut off the power to the SERVOPACK when performing maintenance on it, etc.

(2) Hard Wire Base Block (HWBB) State

The SERVOPACK will be in the following state if the HWBB function operates. If the /HWBB1 or /HWBB2 signal is OFF, the HWBB function will operate and the SERVOPACK will enter a hard wire base block (HWBB) state.

The HWBB function operates after the servomotor power is turned OFF.

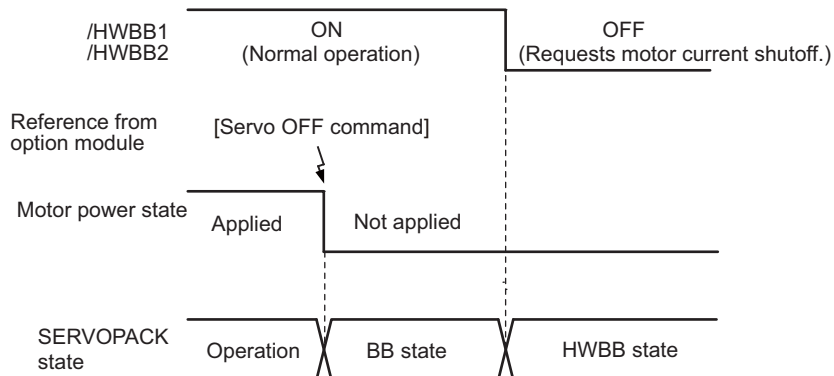

The HWBB function operates during servomotor operation.

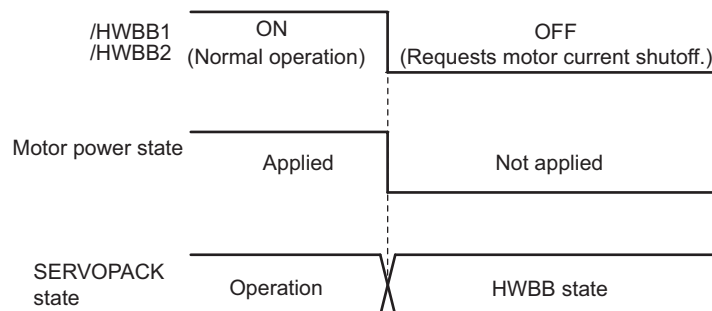

(3) Resetting the HWBB State

By receiving a servo ON command again after both /HWBB1 and /HWBB2 signals are turned ON, the SERVOPACK returns to normal operation status.

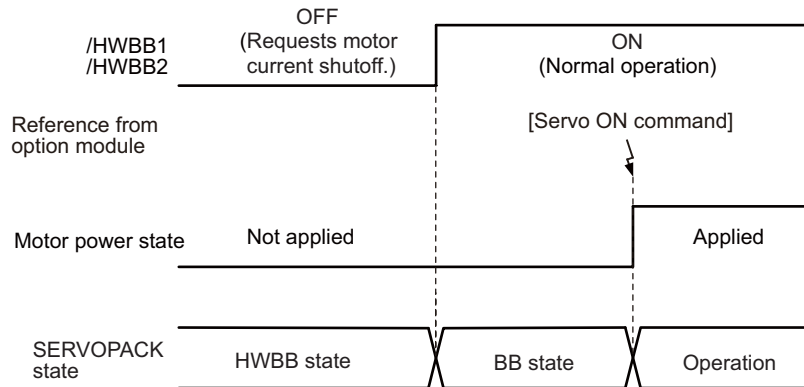

To return to normal operation status:

If a servo ON command has been sent while the SERVOPACK is in the HWBB status,

1. Turn on both /HWBB1 and /HWBB2 signals.
2. Send any command other than a servo ON command, such as a servo OFF command, to change the status of the SERVOPACK from a hard wire base block (HWBB) to a base block (BB).
3. Resend a servo ON command.

Note: Even if the servomotor power is turned OFF by turning OFF the main circuit power, the HWBB status is retained until a servo OFF command is input.

(4) Error Detection in HWBB Signal

If only the /HWBB1 or /HWBB2 signal is input, an A.Eb1 alarm (Safety Function Signal Input Timing Error) will occur unless the other signal is input within 10 seconds. This makes it possible to detect failures, such as disconnection of the HWBB signals.



CAUTION

- The A.Eb1 alarm (Safety Function Signal Input Timing Error) is not related to the safety function. Keep this in mind in the system design.

(5) Connection Example and Specifications of Input Signals (HWBB Signals)

The input signals must be redundant. A connection example and specifications of input signals (HWBB signals) are shown below.



IMPORTANT

For safety function signal connections, the input signal is the 0V common and the output signal is the source output. This is opposite to other signals described in this manual. To avoid confusion, the ON and OFF status of signals for safety functions are defined as follows:

ON: The state in which the relay contacts are closed or the transistor is ON and current flows into the signal line.

OFF: The state in which the relay contacts are open or the transistor is OFF and no current flows into the signal line.

■ Connection Example

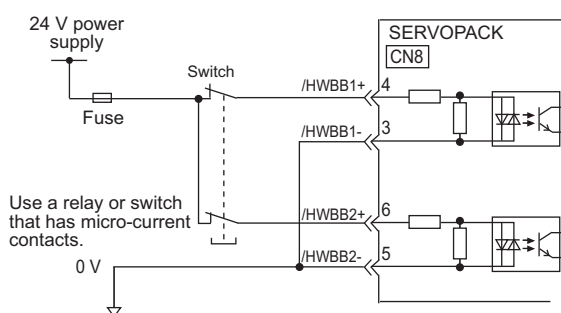

■ Specifications

Type	Signal Name	Pin Number	State	Meaning
Input	/HWBB1	CN8-4	ON	Does not use the HWBB function.
		CN8-3	OFF	Uses the HWBB function.
	/HWBB2	CN8-6	ON	Does not use the HWBB function.
		CN8-5	OFF	Uses the HWBB function.

The input signals (HWBB signals) have the following electrical characteristics.

Items	Characteristics	Remarks
Internal impedance	3.3 kΩ	—
Operation movable voltage range	+11 V to +25 V	—
Maximum delay time	20 ms	Time from the /HWBB1 and /HWBB2 signals are OFF to the HWBB function operates.

If the HWBB function is requested by turning OFF the /HWBB1 and /HWBB2 input signals on the two channels, power supply to the motor will be turned OFF within 20 ms (see below).

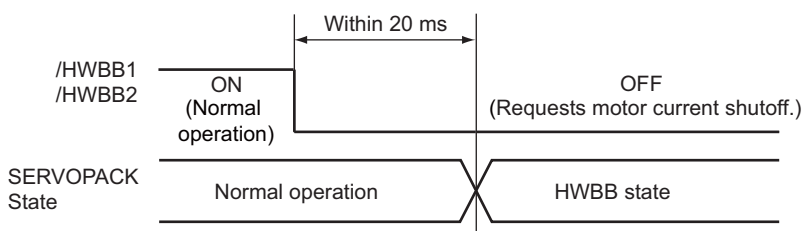

Note: The OFF status is not recognized when the /HWBB1 and /HWBB2 signals are OFF for 0.5 ms or shorter.

(6) Operation with Utility Functions

The HWBB function works while the SERVOPACK operates in utility function mode.

If any of the following utility functions is being used with the /HWBB1 and /HWBB2 signals turned OFF, the SERVOPACK cannot be operated by turning ON the /HWBB1 and /HWBB2 signals. Cancel the utility function first, and then set the SERVOPACK to the utility function mode again and restart operation.

- JOG operation (Fn002)
- Origin search (Fn003)
- Program JOG operation (Fn004)
- Advanced autotuning (Fn201)
- EasyFFT (Fn206)
- Automatic offset-signal adjustment of motor current detection signal (Fn00E)

(7) Brake Signal (/BK)

When the /HWBB1 or /HWBB2 signal is OFF and the HWBB function operates, the brake signal (/BK) will turn OFF. At that time, Pn506 (Brake Reference - Servo OFF Delay Time) will be disabled. Therefore, the servomotor may be moved by external force until the actual brake becomes effective after the brake signal (/BK) turns OFF.

Note: The brake signal output is not related to safety functions. Be sure to design the system so that the system will not be put into danger if the brake signal fails in the HWBB state. Moreover, if a servomotor with a brake is used, keep in mind that the brake for the servomotor is used only to stop the motor from moving and it cannot be used to brake the motor.

(8) Dynamic Brake

If the dynamic brake is enabled in Pn001.0 (stopping method after servomotor power OFF), the servomotor will come to a stop under the control of the dynamic brake when the HWBB function works while the /HWBB1 or /HWBB2 signal is OFF.

Note: The dynamic brake is not related to safety function. Be sure to design the system so that the system will not be put into danger if the servomotor coasts to a stop in the HWBB state. Usually, use a sequence in which the HWBB state occurs after the servomotor is stopped using a command.

CAUTION

If the application frequently uses the HWBB function, do not use the dynamic brake to stop the motor, or otherwise element deterioration in the SERVOPACK may result. Use a sequence in which the HWBB state occurs after the servomotor has come to a stop.

4.6.2 External Device Monitor (EDM1)

The external device monitor (EDM1) functions to monitor failures in the HWBB function. Connect the monitor to feedback signals to the safety unit. The relation of the EDM1, /HWBB1, and /HWBB2 signals is shown below.

Signal Name	Logic			
/HWBB1	ON	ON	OFF	OFF
/HWBB2	ON	OFF	ON	OFF
EDM1	OFF	OFF	OFF	ON

When both /HWBB1 and /HWBB2 signals are OFF, EDM1 signal turns ON.

■ Failure Detection Signal for EDM1 Signal

Detection of failures in the EDM1 circuit can be checked using the status of the 3 signals in the table. Failures can be detected if the failure status can be confirmed, such as when the power supply is turned ON.

 WARNING
The EDM1 signal is not a safety output. Use it only for monitoring a failure.

(1) Connection Example and Specifications of EDM1 Output Signal

Connection example and specifications of EDM1 output signal are explained below.



IMPORTANT

For safety function signal connections, the input signal is the 0V common and the output signal is the source output. This is opposite to other signals described in this manual. To avoid confusion, the ON and OFF status of signals for safety functions are defined as follows:

ON: The state in which the relay contacts are closed or the transistor is ON and current flows into the signal line.

OFF: The state in which the relay contacts are open or the transistor is OFF and no current flows into the signal line.

■ Connection Example

EDM1 output signal is used for source circuit.

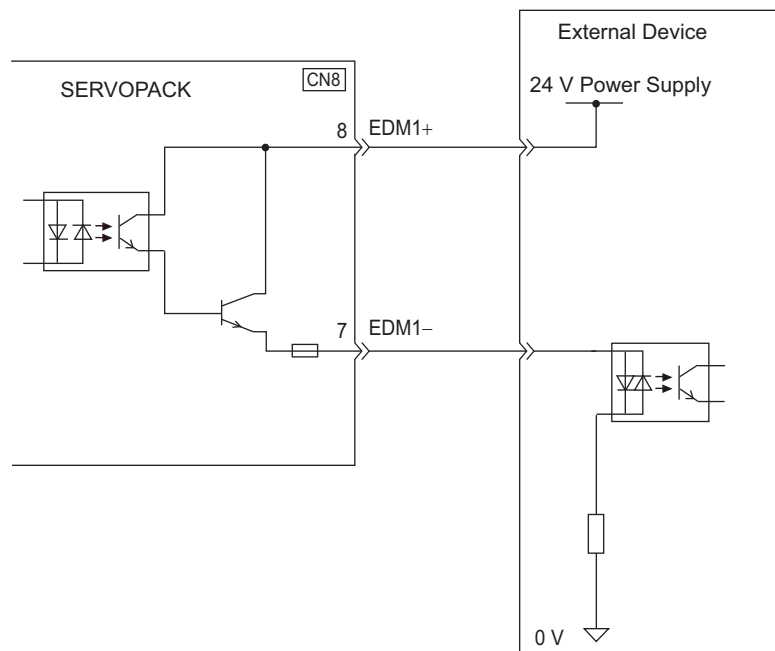

■ Specifications

Type	Signal Name	Pin No.	State	Meaning
Output	EDM1	CN8-8 CN8-7	ON	The /HWBB1 signal and /HWBB2 signal are both operating normally.
			OFF	Both the /HWBB1 signal and /HWBB2 signal are not operating normally or either of the two is not operating normally.

Electrical characteristics of EDM1 signal are as follows.

Items	Characteristics	Remarks
Maximum Allowable Voltage	30 VDC	—
Maximum Current	50 m ADC	—
Maximum Voltage Drop at ON	1.0 V	Voltage between EDM1+ to EDM1- when the current is 50 mA.
Maximum Delay Time	20 ms	Time from change of /HWBB1, /HWBB2 to change of EDM1

4.6.3 Application Example of Safety Functions

An example of using safety functions is shown below.

(1) Connection Example

In the following example, a safety unit is used and the HWBB function operates when the guard opens.

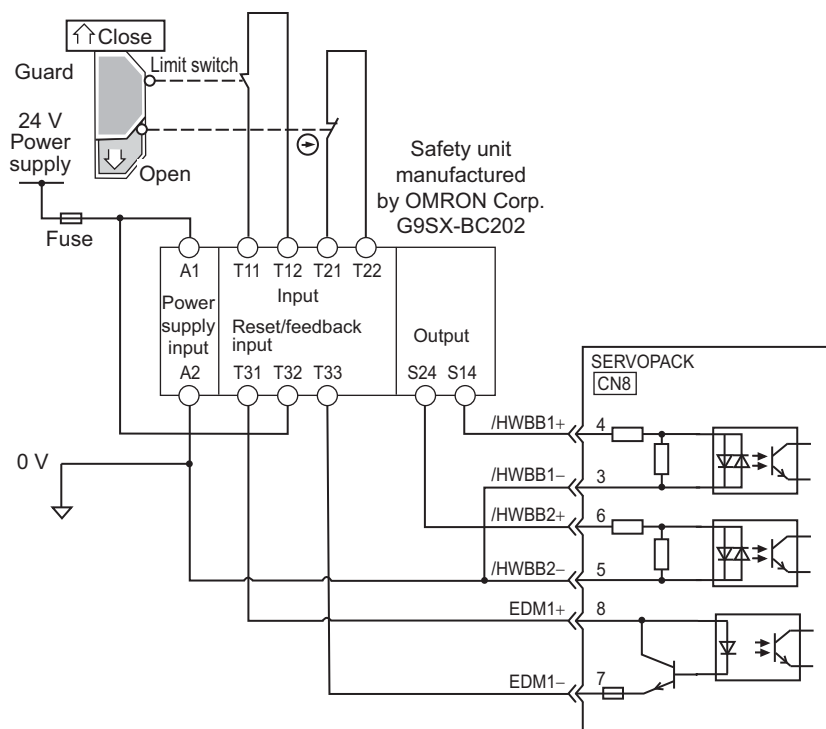

When a guard opens, both of signals, the /HWBB1 and the /HWBB2, turn OFF, and the EDM1 signal is ON. Since the feedback is ON when the guard closes, the safety unit is reset, and the /HWBB1 and the /HWBB2 signals turn ON, and the operation becomes possible.

Note: Connect the EDM1 as the direction of current flows from EDM1+ to EDM1-, because the EDM1 has polarity with a transistor output.

(2) Failure Detection Method

In case of a failure such as the /HWBB1 or the /HWBB2 signal remains ON, the safety unit is not reset because the EDM1 signal keeps OFF. Therefore starting is impossible, then the failure is detected.

An error in the external device, disconnection or short-circuiting of the external wiring, or a failure in the SERVOPACK must be considered. Find the cause and correct the problem.

(3) Usage Example

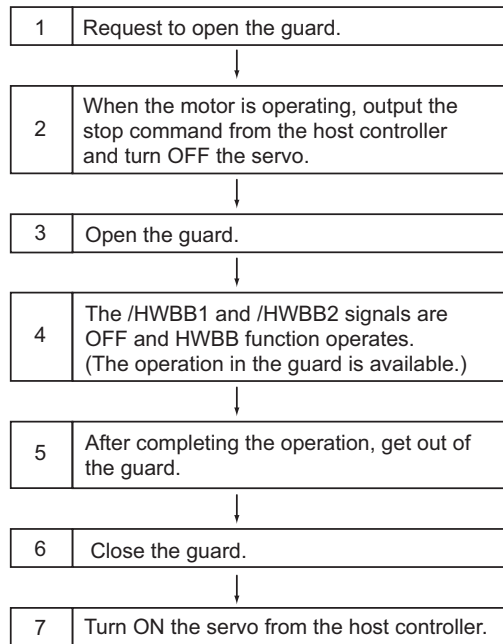
**4.6.4** Confirming Safety Functions

When starting the equipment or replacing the SERVOPACK for maintenance, be sure to conduct the following confirmation test on the HWBB function after wiring.

- When the /HWBB1 and/or /HWBB2 signals turn OFF, check that the digital operator displays “Hbb” and that the motor does not operate.
- Check the ON/OFF states of the /HWBB1 and /HWBB2 signals with bits 0 and 1 of Un015.
→ If the ON/OFF states of the signals do not coincide with the display, an error in the external device, disconnection or short-circuiting of the external wiring, or a failure in the SERVOPACK must be considered. Find the cause and correct the problem.
- Check with the display of the feedback circuit input of the connected device to confirm that the EDM1 signal is OFF while in normal operation.

4.6.5 Connecting a Safety Device

Connect a safety device using the following procedure.

1. Remove the servomotor connection terminal block while pressing the lock.

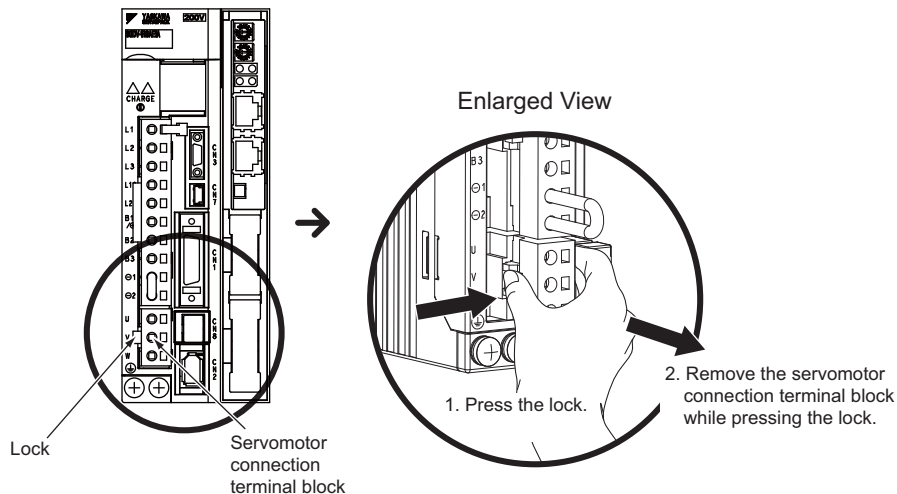

2. Slide the lock injector of the safety function jumper connector to the SERVOPACK side to unlock and remove the safety function jumper connector.

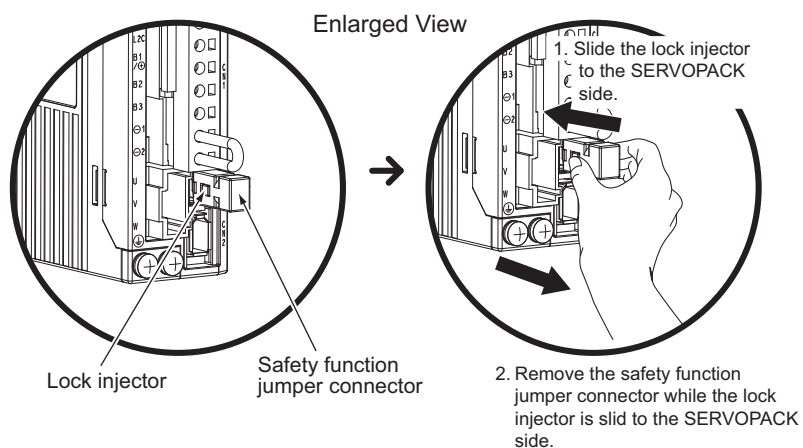

Note: The safety function jumper connector may be damaged if it is removed without being unlocking.

3. Connect a safety device to CN8.

Note: When not using the safety function, use the SERVOPACK with the safety function jumper connector (JZSP-CVH05-E provided as an accessory) inserted in CN8. If the SERVOPACK is used without the jumper connector inserted into CN8, no current will flow to the motor and no torque will be output. In this case, “Hbb” will be displayed on the Digital Operator.

4.6.6 Precautions for Safety Functions



WARNING

- To check that the HWBB function satisfies the safety requirements of the system, be sure to conduct a risk assessment of the system.
Incorrect use of the machine may cause injury.
- The motor rotates if there is external force (e.g., gravity in a vertical axis) when the HWBB function is operating. Therefore, use an appropriate device independently, such as a mechanical brake, that satisfies safety requirements.
Incorrect use of the machine may cause injury.
- While the HWBB function is operating, the motor may rotate within an electric angle of 180° or less as a result of a SERVOPACK failure. Use the HWBB function for applications only after checking that the rotation of the motor will not result in a dangerous condition.
Incorrect use of the machine may cause injury.
- The dynamic brake and the brake signal are not related to safety functions. Be sure to design the system that these failures will not cause a dangerous condition when the HWBB function operates.
Incorrect use of the machine may cause injury.
- The SERVOPACK with its signals for a safety function must be connected to a device that meets safety standards.
Incorrect use of the machine may cause injury.
- If the HWBB function is used for an emergency stop, turn OFF the power supply to the motor with independent electric or mechanical parts.
Incorrect use of the machine may cause injury.
- The HWBB function does not turn OFF the power supply to the SERVOPACK or electrically isolate the SERVOPACK. When maintaining the SERVOPACK, be sure to turn OFF the power supply to the SERVOPACK independently.
Failure to observe this warning may cause an electric shock.

Adjustments

5.1	Adjustments and Basic Adjustment Procedure	5-3
5.1.1	Adjustments	5-3
5.1.2	Basic Adjustment Procedure	5-4
5.1.3	Monitoring Analog Signals	5-5
5.1.4	Safety Precautions on Adjustment of Servo Gains	5-8
5.2	Tuning-less Function	5-10
5.2.1	Tuning-less Function	5-10
5.2.2	Tuning-less Levels Setting (Fn200) Procedure	5-13
5.3	Advanced Autotuning (Fn201)	5-15
5.3.1	Advanced Autotuning	5-15
5.3.2	Advanced Autotuning Procedure	5-17
5.3.3	Related Parameters	5-23
5.4	Advanced Autotuning by Reference (Fn202)	5-24
5.4.1	Advanced Autotuning by Reference	5-24
5.4.2	Advanced Autotuning by Reference Procedure	5-26
5.4.3	Related Parameters	5-30
5.5	One-parameter Tuning (Fn203)	5-31
5.5.1	One-parameter Tuning	5-31
5.5.2	One-parameter Tuning Procedure	5-32
5.5.3	One-parameter Tuning Example	5-38
5.5.4	Related Parameters	5-39
5.6	Anti-resonance Control Adjustment Function (Fn204)	5-40
5.6.1	Anti-resonance Control Adjustment Function	5-40
5.6.2	Anti-resonance Control Adjustment Function Operating Procedure	5-41
5.6.3	Related Parameters	5-45
5.7	Vibration Suppression Function (Fn205)	5-46
5.7.1	Vibration Suppression Function	5-46
5.7.2	Vibration Suppression Function Operating Procedure	5-47
5.7.3	Related Parameters	5-50

5.8 Additional Adjustment Function	5-51
5.8.1 Switching Gain Settings	5-51
5.8.2 Friction Compensation	5-56
5.8.3 Current Control Mode Selection	5-58
5.8.4 Current Gain Level Setting	5-58
5.8.5 Speed Detection Method Selection	5-58
5.9 Compatible Adjustment Function	5-59
5.9.1 Feedforward Reference	5-59
5.9.2 Using the Mode Switch (P/PI Switching)	5-59
5.9.3 Torque Reference Filter	5-64
5.9.4 Position Integral Time Constant	5-65

5.1 Adjustments and Basic Adjustment Procedure

This section describes adjustments and the basic adjustment procedure.

5.1.1 Adjustments

Tuning is performed to optimize the responsiveness of the SERVOPACK.

The responsiveness is determined by the servo gain that is set in the SERVOPACK.

The servo gain is set using a combination of parameters. These parameters influence each other. Therefore, the servo gain must be set considering the balance between the set values.

Generally, the responsiveness of a machine with high rigidity can be improved by increasing the servo gain. If the servo gain of a machine with low rigidity is increased, however, the machine will vibrate and the responsiveness may not be improved.

It is possible to suppress the vibration with a variety of vibration suppression functions in the SERVOPACK.

The servo gains are factory-set to stable values. The following utility function can be used to adjust the servo gain to increase the responsiveness of the machine in accordance with the actual conditions. With this function, these parameters will be adjusted automatically and the need to adjust them individually will be eliminated.

This section describes the following utility adjustment functions.

Utility Function for Adjustment	Outline	Applicable Control Mode
Tuning-less Level Setting (Fn200)	This function is enabled when the factory settings are used. This function can be used to obtain a stable response regardless of the type of machine or changes in the load.	Speed and Position
Advanced Autotuning (Fn201)	The following parameters are automatically adjusted using internal references in the SERVOPACK during automatic operation. <ul style="list-style-type: none"> • Moment of inertia ratio • Gains (position loop gain, speed loop gain, etc.) • Filters (torque reference filter, notch filter) • Friction compensation • Anti-resonance control adjustment function • Vibration suppression 	Speed and Position
Advanced Autotuning by Reference (Fn202)	The following parameters are automatically adjusted with the position reference input from the host controller while the machine is in operation. <ul style="list-style-type: none"> • Gains (position loop gain, speed loop gain, etc.) • Filters (torque reference filter, notch filter) • Friction compensation • Anti-resonance control adjustment function • Vibration suppression 	Position
One-parameter Tuning (Fn203)	The following parameters are automatically adjusted with the position, speed reference input from the host controller while the machine is in operation. <ul style="list-style-type: none"> • Gains (position loop gain, speed loop gain, etc.) • Filters (torque reference filter, notch filter) • Friction compensation • Anti-resonance control adjustment function 	Speed and Position
Anti-resonance Control Adjustment Function (Fn204)	This function effectively suppresses continuous vibration.	Speed and Position
Vibration Suppression Function (Fn205)	This function effectively suppresses residual vibration if it occurs when positioning.	Position

5.1.2 Basic Adjustment Procedure

The basic adjustment procedure is shown in the following flowchart. Make suitable adjustments considering the conditions and operating requirements of the machine.

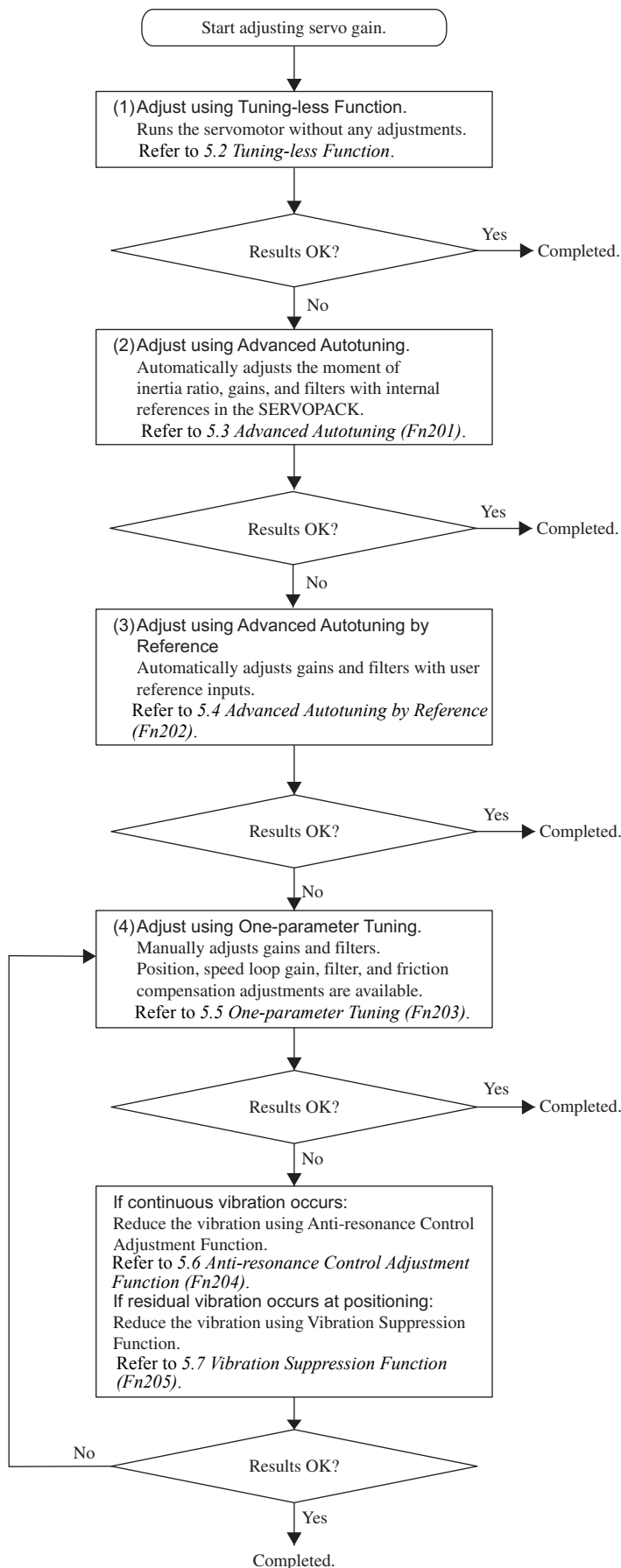

5.1.3 Monitoring Analog Signals

Check the operating status and signal waveform when adjusting the servo gain. Connect a measuring instrument, such as a memory recorder, to connector CN5 on the SERVOPACK to monitor analog signal waveform.

The settings and parameters for monitoring analog signals are described in the following sections.

(1) Monitor Signal

The analog signals that can be monitored are shaded in the following diagram.

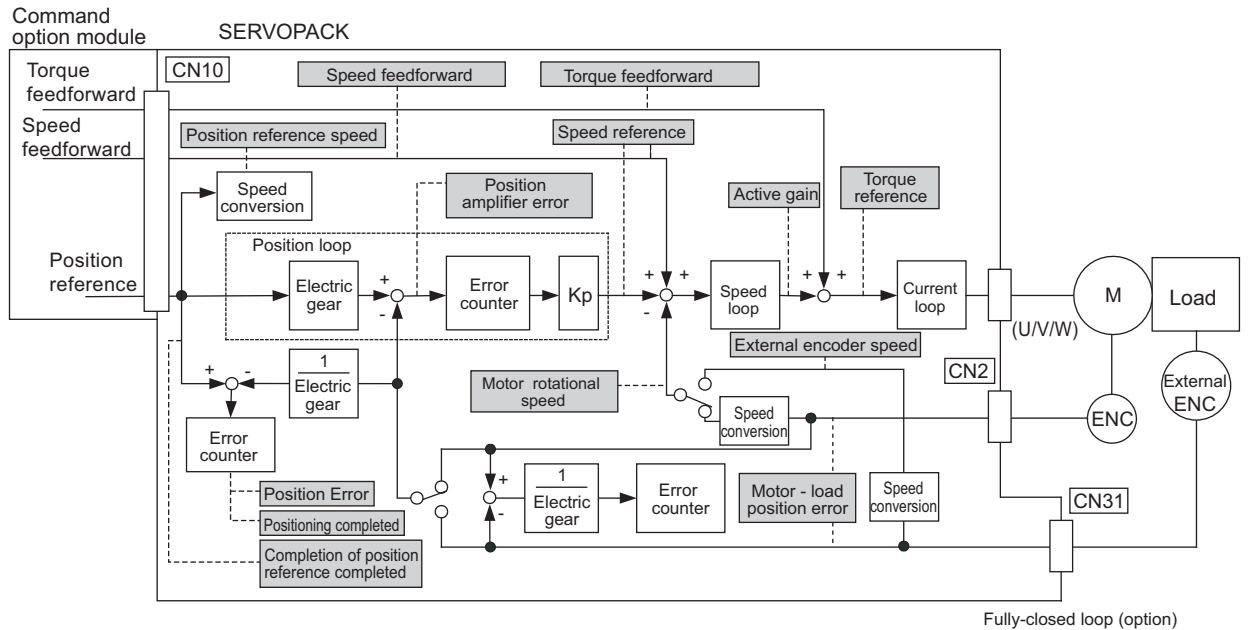

Fully-closed loop (option)

The following signals can be monitored by selecting functions of parameters Pn006 and Pn007. Pn006 is used for analog monitor 1 and Pn007 is used for analog monitor 2.

Parameter	Description		
	Monitor Signal	Measurement Gain	Remarks
Pn006 Pn007	n.□□00	Motor speed	1 V/1000 min ⁻¹ * Pn007 Factory Setting
	n.□□01	Speed reference	1 V/1000 min ⁻¹ *
	n.□□02	Torque reference	1 V/100% rated torque Pn006 Factory Setting
	n.□□03	Position error	0.05 V/reference unit 0 V at speed/torque control
	n.□□04	Position amplifier error	0.05 V/encoder pulse unit Position error after electronic gear conversion
	n.□□05	Position reference speed	1 V/1000 min ⁻¹ *
	n.□□06	Reserved	—
	n.□□07	Motor-load position error	0.01 V/reference unit
	n.□□08	Positioning completed	Positioning completed: 5 V Positioning not completed: 0 V
	n.□□09	Speed feedforward	1 V/1000 min ⁻¹ *
	n.□□0A	Torque feedforward	1 V/100% rated torque
	n.□□0B	Active gain	1 st gain: 1 V 2 nd gain: 2 V
	n.□□0C	Completion of position reference	Completed: 5 V Not completed: 0 V
	n.□□0D	External encoder speed	1 V/1000 min ⁻¹ Value at motor shaft

* When using an SGMCS direct-drive servomotor, the motor speed will be automatically set to 1 V/100 min⁻¹.

(2) Setting Monitor Factor

The output voltages on analog monitor 1 and 2 are calculated by the following equations.

$$\text{Analog monitor 1 output voltage} = (-1) \times \left(\begin{array}{c} \text{Signal selection} \\ (\text{Pn006}=\text{n.00}\square\square) \end{array} \times \begin{array}{c} \text{Multiplier} \\ (\text{Pn552}) \end{array} + \begin{array}{c} \text{Offset voltage [V]} \\ (\text{Pn550}) \end{array} \right)$$

$$\text{Analog monitor 2 output voltage} = (-1) \times \left(\begin{array}{c} \text{Signal selection} \\ (\text{Pn007}=\text{n.00}\square\square) \end{array} \times \begin{array}{c} \text{Multiplier} \\ (\text{Pn553}) \end{array} + \begin{array}{c} \text{Offset voltage [V]} \\ (\text{Pn551}) \end{array} \right)$$

(3) Related Parameters

Use the following parameters to change the monitor factor and the offset.

Pn550	Analog Monitor 1 Offset Voltage <input type="checkbox"/> Speed <input type="checkbox"/> Position <input type="checkbox"/> Torque				Classification
	Setting Range	Setting Unit	Factory Setting	When Enabled	
	-10000 to 10000	0.1 V	0	Immediately	Setup
Pn551	Analog Monitor 2 Offset Voltage <input type="checkbox"/> Speed <input type="checkbox"/> Position <input type="checkbox"/> Torque				Classification
	Setting Range	Setting Unit	Factory Setting	When Enabled	
	-10000 to 10000	0.1 V	0	Immediately	Setup
Pn552	Analog Monitor Magnification (×1) <input type="checkbox"/> Speed <input type="checkbox"/> Position <input type="checkbox"/> Torque				Classification
	Setting Range	Setting Unit	Factory Setting	When Enabled	
	-10000 to 10000	0.01 times	100	Immediately	Setup
Pn553	Analog Monitor Magnification (×1) <input type="checkbox"/> Speed <input type="checkbox"/> Position <input type="checkbox"/> Torque				Classification
	Setting Range	Setting Unit	Factory Setting	When Enabled	
	-10000 to 10000	0.01 times	100	Immediately	Setup

(4) Connector CN5 for Analog Monitor

To monitor analog signals, connect a measuring instrument with cable (JZSP-CA01-E) to the connector CN5.

■ Connection Example

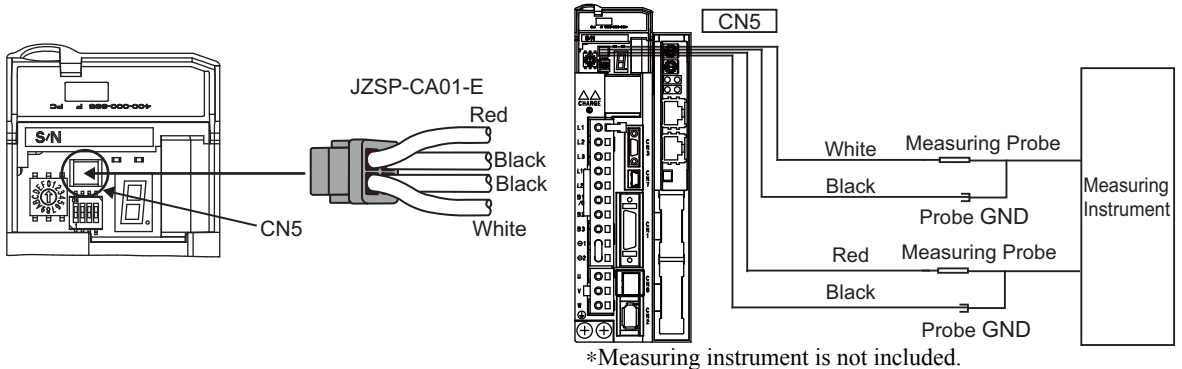

Line Color	Signal Name	Factory Setting
White	Analog monitor 1	Torque reference: 1 V/100% rated torque
Red	Analog monitor 2	Motor speed: 1 V/1000 min ⁻¹ *
Black (2 lines)	GND	Analog monitor GND: 0 V

* When using an SGMCS direct-drive servomotor, the motor speed will be automatically set to 1 V/100 min⁻¹.

<Example>

Analog monitor output at n.□□00 (motor speed setting)

When multiplier is set to × 1:

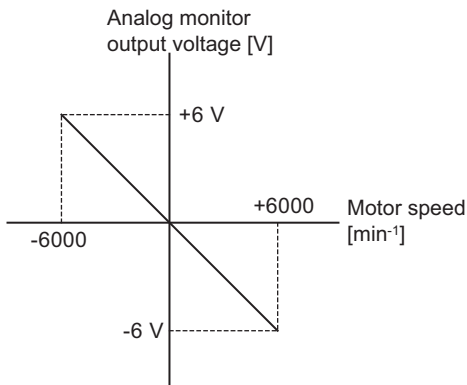

When multiplier is set to × 10:

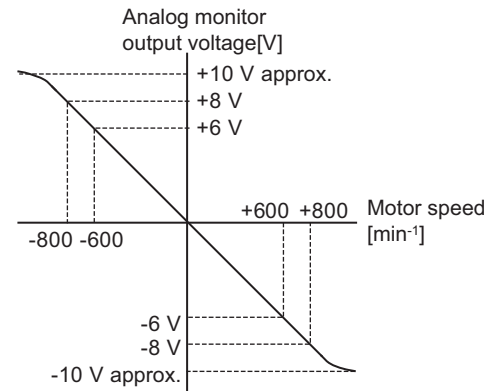

Note: Linear effective range: within ± 8V
Encoder resolution: 16-bit

5.1.4 Safety Precautions on Adjustment of Servo Gains

CAUTION

- If adjusting the servo gains, observe the following precautions.
 - Do not touch the rotating section of the motor while the servomotor power is ON.
 - Before starting the servomotor, make sure that the emergency-stop circuit works correctly.
 - Make sure that a trial run has been performed without any trouble.
 - Install a safety brake on the machine.

Yaskawa recommends that the following protective functions of the SERVOPACK are set to the correct settings before starting to adjust the servo gains.

(1) Overtravel Function

Set the overtravel function. For details on how to set the overtravel function, refer to 4.2.3 *Overtravel*.

(2) Torque Limit

Calculate the torque required to operate the machine. Set the torque limits so that the output torque will not be greater than required. Setting the torque limits can reduce the amount of shock applied to the machine in collisions and other cases.

If the torque is set below the level of torque required to operate the machine, overshooting or vibration may occur.

(3) Excessive Position Error Alarm Level

The excessive position error alarm is a protective function that will be enabled when the servo drive is used in position control mode.

For the optimum setting, the servomotor will be stopped after the error occurs if the servomotor performs unpredictably after receiving a reference.

The position error is the difference between the position reference and the actual position. The position error can be calculated from the position loop gain (Pn102) and the motor speed with the following equation.

$$\text{Position Error} = \frac{\text{Motor Speed} [\text{min}^{-1}]}{60} \times \frac{\text{Encoder Resolution}^{*1}}{\text{Pn102} (1/\text{s})^{*2}}$$

- Excessive Position Error Alarm Level (Pn520 [reference unit])

$$\text{Pn520} > \frac{\text{Max. Motor Speed} [\text{min}^{-1}]}{60} \times \frac{\text{Encoder Resolution}^{*1}}{\text{Pn102} (1/\text{s})^{*2}} \times \underline{(1.2 \text{ to } 2)}$$

*1. Refer to 4.2.4 *Electronic Gear*.

*2. To check the setting for Pn102, set the parameter display to “Displays all parameters” (Pn00B.0 = 1).

Set the level to a value that satisfies these equations, and no alarm will be generated during normal operation. The servomotor will be stopped, however, if the servomotor runs unpredictably after a reference is input. At the end of the equation, a coefficient is shown as “× (1.2 to 2).” This coefficient is used to add a margin that prevents a faulty alarm from occurring in actual operation of the servomotor.

If the servomotor’s maximum number of rotations is 6000 min^{-1} and Pn102 equals 40 with an encoder resolution of 20-bit (1048576), the setting of Pn520 is calculated as shown with the following equation.

$$\begin{aligned} \text{Pn520} &= \frac{6000}{60} \times \frac{1048576}{40} \times 2 \\ &= 2621440 \times 2 \\ &= 5242880 \text{ (The factor setting of Pn520)} \end{aligned}$$

If the acceleration/deceleration of the position reference exceeds the capacity of the servomotor, the servomotor cannot perform at the requested speed, and the allowable level for position error will be increased as not to satisfy these equations. If so, lower the level of the acceleration/deceleration for the position reference so that the servomotor can perform at the requested speed or raise the allowable level of the position errors.

■ Related Parameter

Pn520	Excessive Position Error Alarm Level Position				Classification
	Setting Range	Setting Unit	Factory Setting	When Enabled	
	1 to 1073741823	1 reference unit	5242880	Immediately	Setup

■ Related Alarm

Alarm Display	Alarm Name	Alarm Contents
A.d00	Position Error Pulse Overflow	This alarm occurs when the number of position error pulses exceeds the value set for parameter Pn520 (Excessive Position Error Alarm Level).

(4) Vibration Detection Function

Set the vibration detection function to an appropriate value. For details on how to set the vibration detection function, refer to *6.16 Vibration Detection Level Initialization (Fn01B)*.

(5) Excessive Position Error Alarm Level at Servo ON

If the servomotor is turned ON when position error pulses remain, the servomotor will return to the home position and reset the number of pulses to zero. To prevent the servomotor from moving suddenly, select the appropriate level for the Excessive Position Error alarm when the servomotor is ON to restrict operation of the servomotor.

■ Related Parameters

Pn526	Excessive Position Error Alarm Level at Servo ON Position				Classification
	Setting Range	Setting Unit	Factory Setting	When Enabled	
	1 to 1073741823	1 reference unit	5242880	Immediately	Setup

Pn528	Excessive Position Error Warning Level at Servo ON Position				Classification
	Setting Range	Setting Unit	Factory Setting	When Enabled	
	10 to 100	1%	100	Immediately	Setup

Pn529	Speed Limit Level at Servo ON Position				Classification
	Setting Range	Setting Unit	Factory Setting	When Enabled	
	0 to 10000	1 min ⁻¹	10000	Immediately	Setup

■ Related Alarm

Alarm Display	Alarm Name	Alarm Contents
A.d01	Position Error Pulse Overflow Alarm at Servo ON	Occurs if the servo ON command is received when the number of position error pulses is greater than the set value of Pn526.
A.d02	Position Error Pulse Overflow Alarm by Speed Limit at Servo ON	After a position error pulse has been input, Pn529 limits the speed if the servo ON command is received. If Pn529 limits the speed in such a state, this alarm occurs when the position references are input and the number of position error pulses exceeds the value set for parameter Pn520 (Excessive Position Error Alarm Level).

When an alarm occurs, refer to *9 Troubleshooting* and take the corrective actions.

5.2 Tuning-less Function

The tuning-less function is enabled in the factory settings. Do not disable this function for normal applications. If resonance is generated or excessive vibration occurs during position control, refer to *5.2.2 Tuning-less Levels Setting (Fn200) Procedure* and reduce the set value of Pn170.2 for the tuning-less adjustment level and the set value in Pn170.3 for the tuning-less load level.

CAUTION

- The tuning-less function is enabled in the factory settings. A sound may be heard for a moment when the servomotor power is turned ON for the first time after the SERVOPACK is mounted to the machine. This sound does not indicate any problems; it means that the automatic notch filter was set. The sound will not be heard from the next time the servomotor power is turned ON. For details on the automatic notch filter, refer to (3) *Automatically Setting the Notch Filter* on the next page.
- Set the mode to 2 in Fn200 if a 13-bit encoder is used with the load moment of inertia ratio set to x10 or higher.
- The servomotor may vibrate if the load moment of inertia ratio exceeds the allowable moment of inertia of the servomotor.
If vibration occurs, set the mode to 2 in Fn200 or lower the adjustment level.

5.2.1 Tuning-less Function

The tuning-less function obtains a stable response without adjustment regardless of the type of machine or changes in the load.

(1) Enabling/Disabling Tuning-less Function

The following parameter is used to enable or disable the tuning-less function.

Parameter	Meaning	When Enabled	Classification	
Pn170	n.□□□0	After restart	Setup	
	n.□□□1			Disables tuning-less function.
	n.□□0□			Enables tuning-less function. [Factory setting]
	n.□□1□			Used as speed control. [Factory setting]
	Used as speed control and host controller used as position control.			

(2) Application Restrictions

The tuning-less function can be used in position control or speed control. This function is not available in torque control. The following application restrictions apply to the tuning-less function.

Control Function	Availability	Remarks
Vibration detection level initialization (Fn01B)	Available	
Advanced autotuning (Fn201)	Available (Some conditions apply)	<ul style="list-style-type: none"> • This function can be used when the moment of inertia is calculated. • While this function is being used, the tuning-less function cannot be used temporarily.
Advanced autotuning by reference (Fn202)	Not available	
One-parameter tuning (Fn203)	Not available	
Anti-resonance control adjustment function (Fn204)	Not available	
Vibration suppression function (Fn205)	Not available	
EasyFFT (Fn206)	Available	While this function is being used, the tuning-less function cannot be used temporarily.
Friction compensation	Not available	
Gain switching	Not available	
Offline Moment of Inertia Setting *	Not available	

(cont'd)

Control Function	Availability	Remarks
Mechanical analysis *	Available	While this function is being used, the tuning-less function cannot be used temporarily.

* Operate using SigmaWin+.

(3) Automatically Setting the Notch Filter

Usually, set this function to Auto Setting. (The notch filter is factory-set to Auto Setting.)
If this function is set to Auto Setting, vibration will be detected automatically and the notch filter will be set.

Set this function to Not Auto Setting only if you do not change the notch filter setting before executing tuning-less function.

Parameter	Meaning	When Enabled	Classification
Pn460	n.□0□□	Immediately	Tuning
	n.□1□□		
	Does not set the 2nd notch filter automatically.		
	Sets the 2nd notch filter automatically. [Factory setting]		

(4) Tuning-less Level Settings

Two tuning-less levels are available: the tuning-less adjustment level and tuning-less load level. Both level can be set in the Fn200 utility function and in the Pn170 parameter.

■ Tuning-less Adjustment Level

The servo gain can be adjusted between rigidity level 4 (high gain) and rigidity level 0 (low gain) by changing the tuning-less adjustment level with the utility function and parameter settings.

a) By using the utility function

To change the setting, refer to 5.2.2 *Tuning-less Levels Setting (Fn200) Procedure*.

Tuning Level	Meaning
Level 0	Rigidity level 0
Level 1	Rigidity level 1
Level 2	Rigidity level 2
Level 3	Rigidity level 3
Level 4	Rigidity level 4 [Factory setting]

b) By using the parameter

Parameter	Meaning	When Enabled	Classification
Pn170	n.□0□□	Immediately	Setup
	n.□1□□		
	n.□2□□		
	n.□3□□		
	n.□4□□		
	Rigidity level 0 (Level 0)		
	Rigidity level 1 (Level 1)		
	Rigidity level 2 (Level 2)		
	Rigidity level 3 (Level 3)		
	Rigidity level 4 (Level 4) [Factory setting]		

■ Tuning-less Load Level

The servo gain can be adjusted by using the utility function and parameter settings to change the load level in accordance with the size of the load.

a) By using the utility function

To change the setting, refer to *5.2.2 Tuning-less Levels Setting (Fn200) Procedure*.

Load Level	Meaning
Mode 0	Load level: Low
Mode 1	Load level: Medium [Factory setting]
Mode 2	Low level: High

b) By using by the parameter

Parameter	Meaning	When Enabled	Classification	
Pn170	n.0□□□	Load level: Low (Mode 0)	Immediately	Setup
	n.1□□□	Load level: Medium (Mode 1) [Factory setting]		
	n.2□□□	Low level: High (Mode 2)		

5.2.2 Tuning-less Levels Setting (Fn200) Procedure

CAUTION
To ensure safety, perform tuning-less function in a state where the SERVOPACK can come to an emergency stop at anytime.

The following procedure is used for setting the tuning-less levels.

Setting tuning-less Levels is performed from the digital operator (optional), or SigmaWin+.

The operating procedure from the Digital Operator is described here.

For the basic operation of the digital operator, refer to *Σ-V series User's Manual, Operation of Digital Operator* (SIEP S800000 55).

(1) Before Performing Tuning-less Function





Check the following settings before performing the tuning-less function, or otherwise “NO-OP” will be displayed during the tuning-less operation.

- The tuning-less function must be enabled. (Pn170.0 = 1)
- The write prohibited setting (Fn010) must not be set.

(2) Operating Procedure with Digital Operator

Step	Display after Operation	Keys	Operation
1	<pre> RUN -FUNCTION- Fn080: Pole Detect Fn200: TuneLvl Set Fn201: AAT Fn202: Ref-AAT </pre>		Press the Key to view the main menu for the utility function mode. Use the or Key to move through the list, select Fn200.
2	<pre> RUN -TuneLvlSet- Mode=1 </pre>		Press the Key to display the tuning-less mode setting screen. Notes: If the display does not switch and “NO-OP” is displayed, the write prohibited setting is set in Fn010. Change the setting in Fn010 and press the key again after enabling writing. <ul style="list-style-type: none"> • If the response waveform causes overshooting or if the load moment of inertia exceeds the allowable level (i.e., outside the scope of product guarantee), press the Key and change the mode setting to 2. • If a high-frequency noise is heard, press the Key and change to the mode setting to 0. • The tuning mode can be also changed in Pn170.3.
3	<pre> RUN -TuneLvlSet- Level=<u>4</u> </pre>		Press the Key to display the tuning level setting screen.
4	<pre> RUN -TuneLvlSet- Level=<u>4</u> NF2 ↑ 2nd notch filter </pre>		Press the or Key to select the tuning level. Select the tuning level from 0 to 4. The larger the value, the higher the gain is and the better response performance will be. (The factory setting is 4.) Notes: <ul style="list-style-type: none"> • Vibration may occur if the tuning level is too high. Lower the tuning level if vibration occurs. • If a high-frequency noise is heard, press the Key to automatically set a notch filter for the vibration frequency. • The tuning level can be also changed in Pn170.2.

(cont'd)

Step	Display after Operation	Keys	Operation
5	<pre> RUN -TuneLvISet- Level=4 </pre>		Press the  Key. "DONE" will blink on the status display for approx. 2 s and then "RUN" will be displayed. The settings will be saved in the SERVO-PACK.
6	<pre> RUN -FUNCTION- Fn030 Fn200 Fn201 Fn202 </pre>		Press the  Key to complete the tuning-less operation. The screen in step 1 will appear again.

Note: If the gain level is changed, the automatically set notch filter will be canceled. If vibration occurs, however, the notch filter will be set again.

(3) Alarm and Corrective Actions

The autotuning alarm (A.521) will occur if resonance is generated or excessive vibration occurs during position control.

■ Resonance Sound

Take one of the following actions to correct the problem.

- Reduce the setting of the tuning adjustment level or load level.
- Reduce the setting of Pn170.3 or Pn170.2.

■ Excessive Vibration during Position Control

Take one of the following actions to correct the problem.

- Increase the setting of the tuning load level or reduce the setting of the tuning adjustment level.
- Increase the setting of Pn170.3 or reduce the setting of Pn170.2.

(4) Parameters Disabled by Tuning-less Function

When the tuning-less function is enabled in the factory settings, the setting of these parameters are not available: Pn100, Pn101, Pn102, Pn103, Pn104, Pn105, Pn106, Pn160, Pn139, and Pn408. These gain-related parameters, however, may become effective depending on the executing conditions of the functions specified in the following table. If EasyFFT is executed when the tuning-less function is enabled, the settings in Pn100, Pn104, Pn101, Pn105, Pn102, Pn106, and Pn103, as well as the manual gain switch setting, will be enabled, but the settings in Pn408.3, Pn160.0, and Pn139.0 will be not enabled.

Parameters Disabled by Tuning-less Function			Related Functions and Parameters		
Item	Name	Pn Number	Torque Control	Easy FFT	Mechanical Analysis (Vertical Axis Mode)
Gain	Speed Loop Gain 2nd Speed Loop Gain	Pn100 Pn104	○	○	○
	Speed Loop Integral Time Constant 2nd Speed Loop Integral Time Constant	Pn101 Pn105	×	○	○
	Position Loop Gain 2nd position Loop Gain	Pn102 Pn106	×	○	○
	Moment of Inertia Ratio	Pn103	○	○	○
	Advanced Control	Friction Compensation Switch	Pn408.3	×	×
Anti-resonance Control Switch		Pn160.0	×	×	×
Gain Switching	Gain Switching Switch	Pn139.0	×	×	×

Note: ○: Available
×: Not available

5.3 Advanced Autotuning (Fn201)

This section describes the adjustments with advanced autotuning.



IMPORTANT

- Advanced autotuning starts adjustments based on the set speed loop gain (Pn100). Therefore, precise adjustments cannot be made if there is vibration when starting adjustments. In this case, make adjustments after setting a fully stable gain using one-parameter tuning (Fn203).
- Before performing advanced autotuning with the tuning-less function enabled (Pn170.0 = 1: Factory setting), always set Jcalc to ON to calculate the load moment of inertia. The tuning-less function will automatically be disabled, and the gain will be set by advanced autotuning.
With Jcalc set to OFF so the load moment of inertia is not calculated, "Error" will be displayed on the panel operator, and advanced autotuning will not be performed.
- If the operation conditions, such as the machine load or drive system, are changed by resetting Jcalc to ON to calculate the load moment of inertia after advanced autotuning, then change the related parameters to disable any values that were adjusted before performing advanced autotuning once again. If advanced autotuning is performed without changing the parameters, machine vibration may occur, resulting in damage to the machine.
 - Pn00B.0 = 1 (Displays all parameters.)
 - Pn140.0 = 0 (Does not use model following control.)
 - Pn160.0 = 0 (Does not use anti-resonance control.)
 - Pn408 = n.00□0 (Does not use friction compensation, 1st notch filter, or 2nd notch filter.)

5.3.1 Advanced Autotuning

Advanced autotuning automatically operates the SERVOPACK (in reciprocating movement in the forward and reverse directions) within set limits and makes adjustment automatically according to the mechanical characteristics while the SERVOPACK is operating.

Advanced autotuning can be performed without connecting the host controller. The following automatic operation specifications apply.

- Motor speed: Rated motor speed $\times 2/3$
- Acceleration torque: Approximately 100% of rated motor torque
The acceleration torque varies with the influence of the load moment of inertia ratio (Pn103), machine friction, and external disturbance.
- Movement distance: The travel distance can be set freely. The distance is factory-set to a value equivalent to 3 motor rotations.
For an SGMCS direct drive servomotor, the distance is factory-set to a value equivalent to 0.3 motor rotations.

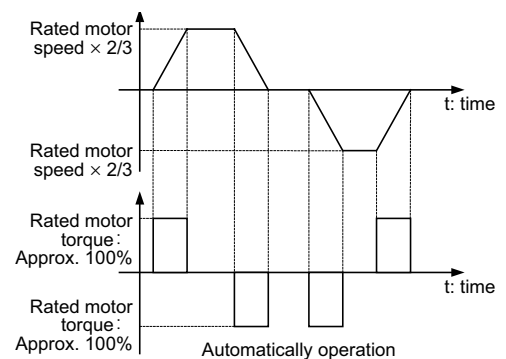
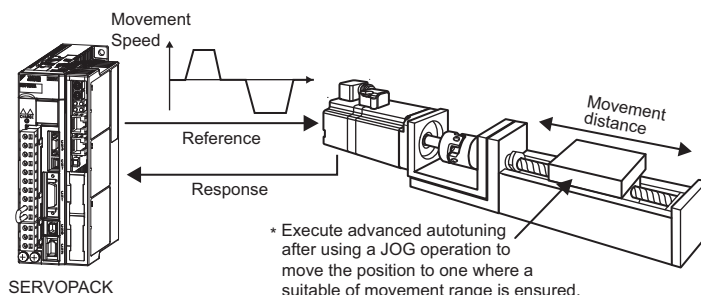

Advanced autotuning performs the following adjustments.

- Moment of inertia ratio
- Gains (e.g., position loop gain and speed loop gain)
- Filters (torque reference filter and notch filter)

- Friction compensation
- Anti-resonance control
- Vibration suppression (Mode = 2 or 3)

Refer to 5.3.3 *Related Parameters* for parameters used for adjustments.

CAUTION

- Because advanced autotuning adjusts the SERVOPACK during automatic operation, vibration or overshooting may occur. To ensure safety, perform advanced autotuning in a state where the SERVOPACK can come to an emergency stop at any time.

(1) Before Performing Advanced Autotuning

Check the following settings before performing advanced autotuning.

The message “NO-OP” indicating that the settings are not appropriate will be displayed, if all of the following conditions are not met.

- The main circuit power supply must be ON.
- There must be no overtravel.
- The servomotor power must be OFF.
- The control method must not be set to torque control.
- The gain selection switch must be in manual switching mode (Pn139.0 = 0).
- Gain setting 1 must be selected.
- The test without a motor function must be disabled (Pn00C.0 = 0).
- All alarms and warning must be cleared.
- The hardwire baseblock (HWBB) must be disabled.
- The write prohibited setting (Fn010) must not be set to write-protect parameters.
- Jcalc must be set to ON to calculate the load moment of inertia when the tuning-less function is enabled (Pn170.0 = 1: factory setting) or the tuning-less function must be disabled (Pn170.0 = 0).

Note:

- If advanced autotuning is started while the SERVOPACK is in speed control, the mode will change to position control automatically to perform advanced autotuning. The mode will return to speed control after completing the adjustment. To perform advanced autotuning in speed control, set the mode to 1 (Mode = 1).

(2) When Advanced Autotuning Cannot be Performed

Advanced autotuning cannot be performed normally under the following conditions. If any of the following conditions exists, perform advanced autotuning by reference or one-parameter tuning.

Refer to 5.4 *Advanced Autotuning by Reference (Fn202)* and 5.5 *One-parameter Tuning (Fn203)* for details.

- The machine system can work only in a single direction.
- The operating range is within 0.5 rotations (Also for SGMCS direct drive motors, the operating range is within 0.05 rotations).

(3) When Advanced Autotuning Cannot be Adjusted

Advanced autotuning may not be performed normally under the following conditions. If the result of autotuning is not satisfactory, perform advanced autotuning by reference or one-parameter tuning.

Refer to 5.4 *Advanced Autotuning by Reference (Fn202)* and 5.5 *One-parameter Tuning (Fn203)* for details.

- The operating range is not applicable.
- The moment of inertia changes within the set operating range.
- The machine has high friction.
- The rigidity of the load is low and vibration occurs when positioning is performed.
- The position integration function is used.
- P control operation (proportional control) is performed.

Note: If a setting is made for calculating the moment of inertia, an error will result when P control operation is selected using /P-CON signal while the moment of inertia is being calculated.

- The mode switch is used.

Note: If a setting is made for calculating the moment of inertia, the mode switch function will be disabled while the moment of inertia is being calculated. At that time, PI control will be used. The mode switch function will be enabled after calculating the moment of inertia.

- Speed feedforward or torque feedforward is input.
- The positioning completed width (Pn522) is too small.

IMPORTANT

- Advanced autotuning makes adjustments based on the positioning completed width (Pn522). If the SERVOPACK is operated in position control, set the electronic gear ratio (Pn20E/Pn210) and positioning completed width (Pn522) to the actual value during operation. If the SERVOPACK is operated in speed control, use the factory settings.
- Unless the positioning completed signal (/COIN) is turned ON within approximately 3 seconds after positioning has been completed, "WAITING" will blink. Furthermore, unless the positioning completed signal (/COIN) is turned ON within approximately 10 seconds, "Error" will blink for 2 seconds and tuning will be aborted.

Change only the overshoot detection level (Pn561) to finely adjust the without changing the positioning completed width (Pn522). Because Pn561 is set by default to 100%, the allowable amount of overshooting is the same amount as that for the positioning completed width.

When Pn561 is set to 0%, the amount of overshooting can be adjusted to prevent any overshooting in the positioning completed width. If the setting of Pn561 is changed, however, the positioning time may be extended.

Pn561	Overshoot Detection Level				Classification	
			Speed	Position		Torque
	Setting Range	Setting Unit	Factory Setting	When Enabled		
	0 to 100	1%	100	Immediately	Setup	

5.3.2 Advanced Autotuning Procedure

The following procedure is used for advanced autotuning.

Advanced autotuning is performed from the Digital Operator (option) or SigmaWin+.

The operating procedure from the Digital Operator is described here.

For the basic operations of the Digital Operator, refer to the *Σ-V series User's Manual, Operation of Digital Operator* (SIEP S800000 55).











⚠ CAUTION

- When using the SERVOPACK with Jcalc = OFF (load moment of inertia is not calculated), be sure to set a suitable value for the moment of inertia ratio (Pn103). If the setting greatly differs from the actual moment of inertia ratio, normal control of the SERVOPACK may not be possible, and vibration may result.

















(1) Operating Procedure

Step	Display after Operation	Keys	Operation
1	<pre> BB — FUNCTION — Fn200: TuneLvl Set Fn201: AAT Fn202: Ref-AAT Fn203: OnePrmTun </pre>	 	<p>Press the Key to view the main menu for the utility function mode.</p> <p>Use the or Key to move through the list, select Fn201.</p>
2	<pre> BB Status Display BB Advanced AT Jcalc=ON Mode=2 Type=2 Stroke=+00800000 (0003. 0) rev </pre>		<p>Press the Key to display the initial setting screen for advanced autotuning.</p>

(cont'd)

Step	Display after Operation	Keys	Operation
3	<pre> BB Advanced AT Jcalc=ON Mode=2 Type=2 Stroke=+00800000 (0003.0) rev </pre>	  	Press the  ,  or  Key and set the items in steps 3-1 to 3-4.
3-1	<p>■Calculating Moment of Inertia Select the mode to be used. Usually, set Jcalc to ON.</p> <p>Jcalc = ON: Moment of inertia calculated [Factory setting] Jcalc = OFF: Moment of inertia not calculated</p> <p>Note: If the moment of inertia is already known from the machine specifications, set the value in Pn103 and set Jcalc to OFF.</p>		
3-2	<p>■Mode Selection Select the mode.</p> <p>Mode = 1: Makes adjustments considering responsiveness and stability. (Standard level) Mode = 2: Makes adjustments for positioning. [Factory setting] Mode = 3: Makes adjustments for positioning, giving priority to overshooting suppression.</p> <p>Note: The mode is always set to 1 if a 13-bit encoder is used (applicable servomotor: SGMJV-□□□A□□□).</p>		
3-3	<p>■Type Selection Select the type according to the machine element to be driven. If there is noise or the gain does not increase, better results may be obtained by changing rigid type.</p> <p>Type = 1: For belt drive mechanisms. Type = 2: For ball screw drive mechanisms [Factory setting]. Type = 3: For rigid systems, such as a gear.</p>		
3-4	<p>■STROKE (Travel Distance) Setting Travel distance setting range: The travel distance setting range is from -99990000 to +99990000. Specify the STROKE (travel distance) in increments of 1000 reference units. The negative (-) direction is for reverse rotation, and the positive (+) direction is for forward rotation.</p> <p>Initial value: About 3 rotations*</p> <p>* If the servomotor's encoder resolution is 1048576 (20-bit), the STROKE (travel distance) will be set to +800000. If the electric gear ratio is set to the factory setting (Pn20E = 4, Pn210 = 1), the initial value is calculated as shown with the following equation.</p> $\frac{800000}{1048576} \times \frac{4}{1} \doteq 3 \text{ rotations}$ <p>Notes:</p> <ul style="list-style-type: none"> Set the number of motor rotations to at least 0.5; otherwise, "Error" will be displayed and the travel distance cannot be set. To calculate the moment of inertia and ensure precise tuning, it is recommended to set the number of motor rotations to around 3. For an SGMCS direct-drive servomotor, the factory setting for the number of motor rotations is 0.3 or equivalent. 		
4	<pre> BB Advanced AT Pn103=00100 Pn100=0040.0 Pn101=0020.00 Pn102=0040.0 </pre>		Press the  Key. The advanced autotuning execution screen will be displayed.
5	<pre> RUN Advanced AT Pn103=00100 Pn100=0040.0 Pn101=0020.00 Pn141=0050.0 </pre>		Press the  Key. The servomotor power will be ON and the display will change from "BB" to "RUN." Note: If the mode is set to 2 or 3, the "Pn102" display will change to the "Pn141."

(cont'd)

Step	Display after Operation	Keys	Operation
6	<pre> ADJ Advanced AT Pn 103=00300 Pn 100=0040.0 Pn 101=0020.00 Pn 141=0050.0 </pre> <p>Display example: After the moment of inertia is calculated.</p>	 	<p>Calculates the moment of inertia.</p> <p>Press the  Key if a positive (+) value is set in STROKE (travel distance), or press the  Key if a negative (-) value is set. Calculation of the moment of inertia ratio will start. While the moment of inertia is being calculated, the set value for Pn103 will blink, and the “RUN” display will change to blinking “ADJ.” When the calculation has been completed, the set value will stop blinking and the calculated moment of inertia ratio will be displayed. The servomotor power will remain ON, but the auto run operation will enter HOLD status.</p> <p>Notes:</p> <ul style="list-style-type: none"> • The wrong key for the set travel direction is pressed, the calculation will not start. • If the moment of inertia is not calculated, the set value for Pn103 will be displayed but not blink. • If “NO-OP” or “Error” are displayed, press the  Key to cancel the function. Refer to (2) <i>Failure in Operation</i> and take a corrective action to enable operation.
7		 	<p>After the motor is temporarily stopped, press the  Key to save the calculated value of the moment of inertia ratio in the SERVOPACK. Then, “DONE” will blink for approx. 1 second, and “ADJ” will be displayed. In the case of calculating the moment of inertia only, press the  Key.</p>
8	<pre> ADJ Advanced AT Pn 103=00300 Pn 100=0100.0 Pn 101=0006.36 Pn 141=0150.0 </pre>	 	<p>■Gain Adjustment</p> <p>When the  or  Key is pressed according to the sign (+ or -) of the value set for STROKE (travel distance), the calculated value of the moment of inertia ratio will be written to the SERVOPACK and the auto run operation will restart. While the servomotor is running, the notch filter, the torque reference filter, and gains will be automatically set. “ADJ” will blink during the auto setting operation.</p> <p>Note: Precise adjustments cannot be made and “Error” will be displayed as the status if there is vibration when starting adjustments. If that occurs, make adjustments using one-parameter tuning (Fn203).</p>
9	<pre> ADJ Advanced AT Pn 103=00300 Pn 100=0100.0 Pn 101=0006.36 Pn 141=0150.0 </pre>		<p>When the adjustment has been completed normally, the servomotor power will turn OFF, and “END” will blink for approx. 2 seconds and “ADJ” will be displayed on the status display.</p>
10	<pre> BB Advanced AT Pn 103=00300 Pn 100=0100.0 Pn 101=0006.36 Pn 141=0150.0 </pre>		<p>Press the  Key. The adjusted values will be written to the SERVOPACK, “DONE” will blink for approx. 2 seconds, and “BB” will be displayed.</p> <p>Note: To not save the values, press the  Key. The display will return to the display in step 1.</p>
11	To enable the change in the setting, turn OFF the power and ON again.		

(2) Failure in Operation

■ If “NO-OP” is shown

Probable Cause	Corrective Actions
The main circuit power supply was OFF.	Turn ON the main circuit power supply.
An alarm or warning occurred.	Remove the cause of the alarm or the warning.
Overtraveling occurred.	Remove the cause of the overtravel.
Gain setting 2 was selected by gain switching.	Turn OFF the automatic gain switching.
The HWBB function operated.	Cancel the HWBB function.

■ If “Errors” is shown

Error	Probable Cause	Corrective Actions
The gain adjustment was not successfully completed.	<ul style="list-style-type: none"> Machine vibration is occurring or the positioning completed signal (/COIN) is repeatedly turning ON and OFF. 	<ul style="list-style-type: none"> Increase the set value for Pn522. Change the mode from 2 to 3. If machine vibration occurs, suppress the vibration with the anti-resonance control adjustment function and the vibration suppression function.
An error occurred during the calculation of the moment of inertia.	Refer to the following table ■ <i>Errors during Calculation of Moment of Inertia</i> .	
Travel distance setting error	The travel distance is set to approximately 0.5 rotation (0.05 rotation for SGMCS servomotor) or less, which is less than the minimum adjustable travel distance.	Increase the travel distance. It is recommended to set the number of motor rotations to around 3.
The positioning completed signal (/COIN) did not turn ON within approximately 10 seconds after positioning adjustment was completed.	The positioning completed width is too narrow or the proportional control (P control) is being used.	<ul style="list-style-type: none"> Increase the set value for Pn522. If P control is used, turn OFF the /P-CON signal.
A setting error occurred in the moment of inertia calculation when the tuning-less function was activated.	Jcalc was set to OFF, so the moment of inertia was not calculated and the tuning-less function was activated.	<ul style="list-style-type: none"> Turn OFF the tuning-less function. Set Jcalc to ON, so the moment of inertia will be calculated.

■ Errors during Calculation of Moment of Inertia

The following table shows the probable causes of errors that may occur during the calculation of the moment of inertia with the Jcalc set to ON, along with corrective actions for the errors.

Error Display	Cause	Corrective Action
Err1	The SERVOPACK started calculating the moment of inertia, but the calculation was not completed.	<ul style="list-style-type: none"> Increase the speed loop gain (Pn100). Increase the STROKE (travel distance).
Err2	The moment of inertia fluctuated greatly and did not converge within 10 tries.	Set the calculation value based on the machine specifications in Pn103 and execute the calculation with the Jcalc set to OFF.
Err3	Low-frequency vibration was detected.	Double the calculation starting level of the moment of inertia (Pn324).
Err4	The torque limit was reached.	<ul style="list-style-type: none"> Increase the torque limit value. Double the calculation starting level of the moment of inertia (Pn324).
Err5	While calculating the moment of inertia, the speed control was set to proportional control with P-CON input.	Operate the SERVOPACK with PI control while calculating the moment of inertia.

(3) Related Functions

■ Notch Filter

Usually, set this function to Auto Setting. (The notch filter is factory-set to Auto Setting.)
If this function is set to Auto Setting, vibration will be detected automatically and the notch filter will be set.

Set this function to Not Auto Setting only if you do not change the notch filter setting before executing advanced autotuning.

Parameter		Function	When Enabled	Classification
Pn460	n.□□□0	Does not set the 1st notch filter automatically.	Immediately	Tuning
	n.□□□1	Sets the 1st notch filter automatically. [Factory setting]		
	n.□0□□	Does not set the 2nd notch filter automatically.		
	n.□1□□	Sets the 2nd notch filter automatically. [Factory setting]		

■ Anti-Resonance Control Adjustment Function

This function reduces low vibration frequency; which the notch filter does not detect.

Usually, set this function to Auto Setting. (The anti-resonance control is factory-set to Auto Setting.)
When this function is set to Auto Setting, vibration will be automatically detected during advanced autotuning and anti-resonance control will be automatically adjusted and set.

Parameter		Function	When Enabled	Classification
Pn160	n.□□0□	Does not use the anti-resonance control automatically.	After restart	Tuning
	n.□□1□	Uses the anti-resonance control automatically. [Factory setting]		

■ Vibration Suppression

The vibration suppression function suppresses transitional vibration at frequency as low as 1 to 100 Hz that is generated mainly when positioning if the machine stand vibrates.

Usually, set this function to Auto Setting. (The vibration suppression function is factory-set to Auto Setting.)
When this function is set to Auto Setting, vibration will be automatically detected during advanced autotuning and model following control with vibration suppression will be automatically adjusted and set.
Set this function to Not Auto Setting only if you do not change the setting for model following control with vibration suppression before executing advanced autotuning.

Note: This function uses model following control. Therefore, the function can be executed only if the mode is set to 2 or 3.

Related Parameters

Parameter		Function	When Enabled	Classification
Pn140	n.□0□□	Does not use the vibration suppression function automatically.	Immediately	Tuning
	n.□1□□	Uses the vibration suppression function automatically. [Factory setting]		

■ Friction Compensation

This function compensates for changes in the following conditions.

- Changes in the viscous resistance of the lubricant, such as the grease, on the sliding parts of the machine
- Changes in the load resistance resulting from fluctuations in the machine assembly
- Secular changes in the load resistance

Conditions to which friction compensation is applicable depend on the mode. The friction compensation setting in Pn408.3 applies when the mode is 1.

Friction Compensation Selecting		Mode		
		Mode = 1	Mode = 2	Mode = 3
Pn408	n.0□□□ [Factory setting]	Adjusted without the friction compensation function.	Adjusted with the friction compensation function.	Adjusted with the friction compensation function.
	n.1□□□	Adjusted with the friction compensation function.	Adjusted with the friction compensation function.	Adjusted with the friction compensation function.

■ Feedforward

 IMPORTANT	<ul style="list-style-type: none"> • Model following control is used to make optimum feedforward settings in the servo. Therefore, model following control from the host controller is not used together with either the speed feedforward input or torque feedforward input. An improper speed feedforward input or torque feedforward input may result in overshooting.
--	--

If Pn140 is set to the factory setting and the mode setting is changed to 2 or 3, the feedforward gain (Pn109) (refer to 5.9.1) will become unavailable.

The following settings are required if model following control is used from the host controller (through the command option module) together with the speed feedforward input or torque feedforward input.

Parameter	Function	When Enabled	Classification
Pn140	n.0□□□ Model following control is not used together with speed/torque feedforward input. [Factory setting]	Immediately	Tuning
	n.1□□□ Model following control is used together with speed/torque feedforward input.		

5.3.3 Related Parameters

The following parameters are set automatically by using advanced autotuning function.

Parameter	Name
Pn100	Speed Loop Gain
Pn101	Speed Loop Integral Time Constant
Pn102	Position Loop Gain
Pn121	Friction Compensation Gain
Pn123	Friction Compensation Coefficient
Pn124	Friction Compensation Frequency Correction
Pn125	Friction Compensation Gain Correction
Pn141	Model Following Control Gain
Pn143	Model Following Control Bias (Forward Direction)
Pn144	Model Following Control Bias (Reverse Direction)
Pn145	Vibration Suppression 1 Frequency A
Pn146	Vibration Suppression 1 Frequency B
Pn147	Model Following Control Speed Feedforward Compensation
Pn161	Anti-Resonance Frequency
Pn163	Anti-Resonance Damping Gain
Pn401	1st Step 1st Torque Reference Filter Time Constant
Pn408	Notch Filter Selection/Friction Compensation Selection
Pn409	1st Notch Filter Frequency
Pn40A	1st Notch Filter Q Value
Pn40C	2nd Notch Filter Frequency
Pn40D	2nd Notch Filter Q Value

5.4 Advanced Autotuning by Reference (Fn202)

This section describes the adjustments with advanced autotuning by reference.



IMPORTANT

- Advanced autotuning by reference starts adjustments based on the set speed loop gain (Pn100). Therefore, precise adjustments cannot be made if there is vibration when starting adjustments. In this case, make adjustments after setting a fully stable gain using one-parameter tuning (Fn203).

5.4.1 Advanced Autotuning by Reference

Advanced autotuning by reference is used to automatically achieve optimum tuning of the SERVOPACK in response to the user reference inputs from the host controller.

Advanced autotuning by reference is performed generally to fine-tune the SERVOPACK after advanced autotuning of the SERVOPACK has been performed.

If the load moment of inertia ratio is set correctly is Pn103, advanced autotuning by reference can be performed without performing advanced autotuning.

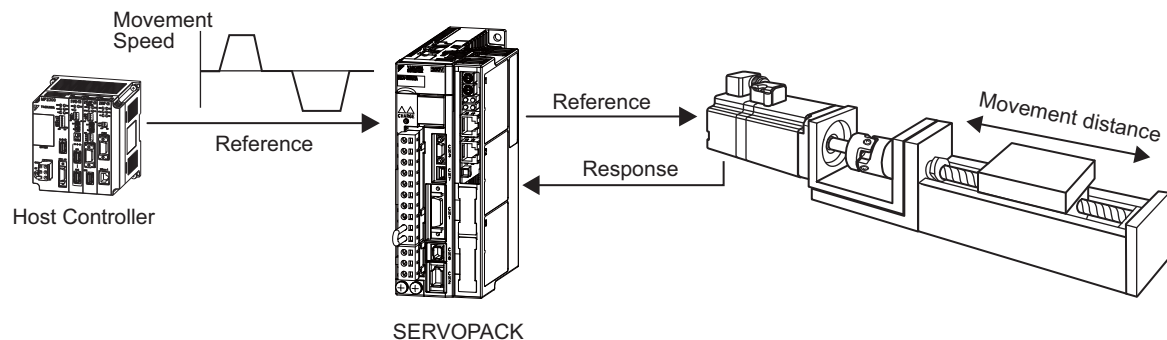

Advanced autotuning by reference performs the following adjustments.

- Gains (e.g., position loop gain and speed loop gain)
- Filters (torque reference filter and notch filter)
- Friction compensation
- Anti-resonance control
- Vibration suppression

Refer to 5.4.3 *Related Parameters* for parameters used for adjustments.

For information on how to input operation references, refer to the manual of the connected command option module.



CAUTION

- Because advanced autotuning by reference adjusts the SERVOPACK during automatic operation, vibration or overshooting may occur. To ensure safety, perform advanced autotuning by reference in a state where the SERVOPACK can come to an emergency stop at any time.
- Be sure to set a suitable value for the moment of inertia ratio (Pn103) using advanced autotuning before advanced autotuning by reference is performed. If the setting greatly differs from the actual moment of inertia ratio, normal control of the SERVOPACK may not be possible, and vibration may result.

(1) Before Performing Advanced Autotuning by Reference

Check the following settings before performing advanced autotuning by reference. The message “NO-OP” indicating that the settings are not appropriate will be displayed, if all of the following conditions are not met.

- The main circuit power supply must be ON.
- There must be no overtravel.
- The servomotor power must be OFF.
- The position control must be selected when the servomotor power is ON.
- The gain selection switch must be in manual switching mode (Pn139.0 = 0).
- Gain setting 1 must be selected.
- The test without a motor function must be disabled. (Pn00C.0 = 0).
- All alarms and warnings must be cleared.
- The hardwire baseblock (HWBB) must be OFF.
- The write prohibited setting (Fn010) must not be set to write-protect parameters.
- The tuning-less function must be disabled (Pn170.0 = 0).
- The SENS_ON command is received. (when an absolute encoder is used.)

(2) When Advanced Autotuning by Reference Cannot Be Adjusted

Advanced autotuning by reference may not be performed normally under the following conditions. If the result of autotuning is not satisfactory, perform one-parameter tuning. Refer to 5.5 *One-parameter Tuning (Fn203)* for details.

- The travel distance in response to references from the host controller is the same as or smaller than the set positioning completed width (Pn522).
- The motor speed in response to references from the host controller is the same as or smaller than the set rotation detection level (Pn502).
- The stopping time, i.e., the period while the positioning completed /COIN signal is OFF, is 10 ms or shorter.
- The rigidity of the load is low and vibration occurs when positioning is performed.
- The position integration function is used.
- P control operation (proportional control) is performed.
- The mode switch is used.
- The positioning completed width (Pn522) is too small.



IMPORTANT

- Advanced autotuning by reference makes adjustments based on the positioning completed width (Pn522). Set the electronic gear ratio (Pn20E/Pn210) and positioning completed width (Pn522) to the actual value during operation.
- Unless the positioning completed signal (/COIN) is turned ON within approximately 3 seconds after positioning has been completed, “WAITING” will blink. Furthermore, unless the positioning completed signal (/COIN) is turned ON within approximately 10 seconds, “Error” will blink for 2 seconds and tuning will be aborted.

Change only the overshoot detection level (Pn561) to finely adjust the without changing the positioning completed width (Pn522). Because Pn561 is set by default to 100%, the allowable amount of overshooting is the same amount as that for the positioning completed width.

When Pn561 is set to 0%, the amount of overshooting can be adjusted without any overshooting in the positioning completed width. If the setting of Pn561 is changed, however, the positioning time may be extended.

Pn561	Overshoot Detection Level				Classification	
	Setting Range	Setting Unit	Speed	Position		Torque
			Factory Setting	When Enabled		
	0 to 100	1%	100	Immediately		Setup

5.4.2 Advanced Autotuning by Reference Procedure





















The following procedure is used for advanced autotuning by reference.

Advanced autotuning by reference is performed from the Digital Operator (option) or SigmaWin+.



The operating procedure from the Digital Operator is described here.

For basic operations of the Digital Operator, refer to the *Σ-V series User's Manual, Operation of Digital Operator* (SIEP S800000 55).

(1) Operating Procedure

Step	Display after Operation	Keys	Operation
1	<pre> BB — FUNCTION — Fn201: AAT Fn202: Ref-AAT Fn203: OnePrmTun Fn204: A-Vib Sup </pre>	  	<p>Press the  Key to view the main menu for the utility function mode.</p> <p>Use the  or  Key to move through the list, select Fn202.</p>
2	<pre> Status Display BB Advanced AT Mode=3 Type=2 </pre>		<p>Press the  Key to display the initial setting screen for advanced autotuning by reference.</p>
3	<pre> BB Advanced AT Mode=3 Type=2 </pre>	  	<p>Press the   or  Key and set the items in steps 3-1 and 3-2.</p>
3-1	<p>■Mode Selection Select the mode. Mode = 1: Makes adjustments considering responsiveness and stability. (Standard level) Mode = 2: Makes adjustments for positioning. [Factory setting] Mode = 3: Makes adjustments for positioning, giving priority to overshooting suppression. Note: The mode is always set to 1 if a 13-bit encoder is used (applicable servomotor: SGMJV-□□□A□□□).</p>		
3-2	<p>■Type Selection Select the type according to the machine element to be driven. If there is noise or the gain does not increase, better results may be obtained by changing the rigid type. Type = 1: For belt drive mechanisms. Type = 2: For ball screw drive mechanisms [Factory setting]. Type = 3: For rigid systems, such as a gear.</p>		
4	<pre> BB Advanced AT Pn103=00000 Pn100=0040.0 Pn101=0020.00 Pn141=0050.0 </pre>		<p>Press the  Key. The advanced autotuning execution screen will be displayed. Note: If the mode is set to 2 or 3, the “Pn102” display will change to the “Pn141”.</p>
5	<pre> RUN Advanced AT Pn103=00300 Pn100=0040.0 Pn101=0020.00 Pn141=0050.0 </pre>		<p>Input a servo ON command.</p>
6	<pre> ADJ Advanced AT Pn103=00300 Pn100=0100.0 Pn101=0006.36 Pn141=0150.0 </pre>	 	<p>Start to adjust using  or  Key. “ADJ” will blink on the status display. Note: Adjustment cannot be performed during “BB” is shown on the status display.</p>
7	<pre> ADJ Advanced AT Pn103=00300 Pn100=0100.0 Pn101=0006.36 Pn141=0150.0 </pre>		<p>When the adjustment has been completed normally, “END” will blink for approx. 2 seconds and “ADJ” will be displayed on the status display.</p>

(cont'd)

Step	Display after Operation	Keys	Operation
8	<pre> RUN Advanced AT P n 103=00300 P n 100=0100. 0 P n 101=0006. 36 P n 141=0150. 0 </pre>		<p>Press the  Key. The adjusted values will be written to the SERVOPACK, “DONE” will blink for approx. 2 seconds, and then “RUN” will be displayed.</p> <p>Note: To not save the values set in step 6, press the  Key. The display will return to the display in step 1.</p>
9	To enable the change in the setting, turn OFF the power and ON again.		

(2) Failure in Operation

■ If “NO-OP” is shown

Probable Cause	Corrective Actions
The main circuit power supply was OFF.	Turn ON the main circuit power supply.
An alarm or warning occurred.	Remove the cause of the alarm or the warning.
Overtraveling occurred.	Remove the cause of the overtravel.
Gain setting 2 was selected by gain switching.	Turn OFF the automatic gain switching.
The HWBB function operated.	Cancel the HWBB function.

■ If “Error” is shown

Error	Probable Cause	Corrective Actions
The gain adjustment was not successfully completed.	Machine vibration is occurring or the positioning completed signal (/COIN) is repeatedly turning ON and OFF.	<ul style="list-style-type: none"> • Increase the set value for Pn522. • Change the mode from 2 to 3. • If machine vibration occurs, suppress the vibration with the anti-resonance control adjustment function and the vibration suppression function.
The positioning completed signal (/COIN) did not turn ON within approximately 10 seconds after positioning adjustment was completed.	The positioning completed width is too narrow or the proportional control (P control) is being used.	<ul style="list-style-type: none"> • Increase the set value for Pn522. • If P control is used, turn OFF the /P-CON signal.

(3) Related Functions

■ Notch Filter

Usually, set this function to Auto Setting. (The notch filter is factory-set to Auto Setting.)
If this function is set to Auto Setting, vibration will be detected automatically and the notch filter will be set.

Set this function to Not Auto Setting only if you do not change the notch filter setting before executing advanced autotuning by reference.

Parameter		Function	When Enabled	Classification
Pn460	n.□□□0	Does not set the 1st notch filter automatically.	Immediately	Tuning
	n.□□□1	Sets the 1st notch filter automatically. [Factory setting]		
	n.□0□□	Does not set the 2nd notch filter automatically.		
	n.□1□□	Sets the 2nd notch filter automatically. [Factory setting]		

■ Anti-Resonance Control Adjustment Function

This function reduces low vibration frequency; which the notch filter does not detect.

Usually, set this function to Auto Setting. (The anti-resonance control is factory-set to Auto Setting.)
When this function is set to Auto Setting, vibration will be automatically detected during advanced autotuning by reference and anti-resonance control will be automatically adjusted and set.

Parameter		Function	When Enabled	Classification
Pn160	n.□□0□	Does not use the anti-resonance control automatically.	After restart	Tuning
	n.□□1□	Uses the anti-resonance control automatically. [Factory setting]		

■ Vibration Suppression

The vibration suppression function suppresses transitional vibration at frequency as low as 1 to 100 Hz that is generated mainly when positioning if the machine stand vibrates.

Usually, set this function to Auto Setting. (The vibration suppression function is factory-set to Auto Setting.)
When this function is set to Auto Setting, vibration will be automatically detected during advanced autotuning by reference and model following control with vibration suppression will be automatically adjusted and set.
Set this function to Not Auto Setting only if you do not change the setting for model following control with vibration suppression before executing advanced autotuning by reference.

Note: This function uses model following control. Therefore, the function can be executed only if the mode is set to 2 or 3.

Related Parameters

Parameter		Function	When Enabled	Classification
Pn140	n.□0□□	Does not use the vibration suppression function automatically.	Immediately	Tuning
	n.□1□□	Uses the vibration suppression function automatically. [Factory setting]		

■ Friction Compensation

This function compensates for changes in the following conditions.

- Changes in the viscous resistance of the lubricant, such as the grease, on the sliding parts of the machine
- Changes in the load resistance resulting from fluctuations in the machine assembly
- Secular changes in the load resistance

Conditions to which friction compensation is applicable depend on the mode. The friction compensation setting in Pn408.3 applies when the mode is 1.

Friction Compensation Selecting		Mode = 1	Mode = 2	Mode = 3
Pn408	n.0□□□ [Factory setting]	Adjusted without the friction compensation function.	Adjusted with the friction compensation function.	Adjusted with the friction compensation function.
	n.1□□□	Adjusted with the friction compensation function.	Adjusted with the friction compensation function.	Adjusted with the friction compensation function.

■ Feedforward



IMPORTANT

- Model following control is used to make optimum feedforward settings in the servo. Therefore, model following control is not used from the host controller together with either the speed feedforward input or torque feedforward input. An improper speed feedforward input or torque feedforward input may result in overshooting.

If Pn140 is set to the factory setting and the mode setting is changed to 2 or 3, the feedforward reference (Pn109) (refer to 5.9.1) will be lost.

The following settings are required if model following control is used from the host controller (through the command option module) together with the speed feedforward input or torque feedforward input.

Parameter	Function	When Enabled	Classification
Pn140	n.0□□□ [Factory setting]	Immediately	Tuning
	n.1□□□		

5.4.3 Related Parameters

The following parameters are set automatically by using advanced autotuning by reference. Manual adjustments are not required.

Parameter	Name
Pn100	Speed Loop Gain
Pn101	Speed Loop Integral Time Constant
Pn102	Position Loop Gain
Pn121	Friction Compensation Gain
Pn123	Friction Compensation Coefficient
Pn124	Friction Compensation Frequency Correction
Pn125	Friction Compensation Gain Correction
Pn141	Model Following Control Gain
Pn143	Model Following Control Bias (Forward Direction)
Pn144	Model Following Control Bias (Reverse Direction)
Pn145	Vibration Suppression 1 Frequency A
Pn146	Vibration Suppression 1 Frequency B
Pn147	Model Following Control Speed Feedforward Compensation
Pn161	Anti-Resonance Frequency
Pn163	Anti-Resonance Damping Gain
Pn401	1st Step 1st Torque Reference Filter Time Constant
Pn408	Notch Filter Selection/Friction Compensation Selection
Pn409	1st Notch Filter Frequency
Pn40A	1st Notch Filter Q Value
Pn40C	2nd Notch Filter Frequency
Pn40D	2nd Notch Filter Q Value

5.5 One-parameter Tuning (Fn203)

This section describes the adjustments with one-parameter tuning.

5.5.1 One-parameter Tuning

One-parameter tuning is used to manually make tuning level adjustments during operation with a position reference or speed reference input from the host controller.

One-parameter tuning enables automatically setting related servo gain settings to balanced conditions by adjusting one or two autotuning levels.

One-parameter tuning performs the following adjustments.

- Gains (e.g., position loop gain and speed loop gain)
- Filters (torque reference filter and notch filter)
- Friction compensation
- Anti-resonance control

Refer to *5.5.4 Related Parameters* for parameters used for adjustments.

For information on how to input position references or speed references, refer to the manual of the connected command option module.

Perform one-parameter tuning if satisfactory responsiveness is not obtained with advanced autotuning or advanced autotuning by reference.

To fine-tune each servo gain after one-parameter tuning, refer to *5.8 Additional Adjustment Function*.



CAUTION

- Vibration or overshooting may occur during adjustment. To ensure safety, perform one-parameter tuning in a state where the SERVOPACK can come to an emergency stop at any time.
- Be sure to set a suitable value for the moment of inertia ratio (Pn103) using advanced autotuning before one-parameter tuning is performed. If the setting greatly differs from the actual moment of inertia ratio, normal control of the SERVOPACK may not be possible, and vibration may result.

(1) Before Performing One-parameter Tuning

Check the following settings before performing one-parameter tuning.

- a) A message (NO-OP) indicating that no operations are possible will be displayed, if all of the following conditions are not met.
 - The tuning-less function must not be enabled.
 - Test without motor function must not be enabled. (Pn00C.0 = 0)
- b) Observe the following condition to ensure operation.
 - The write prohibited setting (Fn010) must not be set.
 - The tuning mode must be set to 0 or 1 in speed control.

(2) Usage Restrictions

The tuning mode is restricted to 0 or 1 if speed control is used.

5.5.2 One-parameter Tuning Procedure

The following procedure is used for one-parameter tuning.

Operation procedures will vary in accordance with the tuning mode being used.























- When the tuning mode is set to 0 with priority given to stability or when the tuning mode is set to 1 with priority given to responsiveness, refer to (1) *Setting the Tuning Mode to 0 or 1*.
- When the tuning mode is set to 2 or 3 for adjustments in positioning, refer to (2) *Setting the Tuning Mode to 2 or 3*.

One-parameter tuning is performed from the Digital Operator (option) or SigmaWin+.











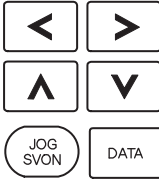





The operating procedure from the Digital Operator is described here.

For basic operations of the Digital Operator, refer to the *Σ -V series User's Manual, Operation of Digital Operator* (SIEP S800000 55).























(1) Setting the Tuning Mode to 0 or 1

Step	Display after Operation	Keys	Operation
1	<pre> RUN —FUNCTION— Fn202: Ref-AAT Fn203: OnePrmTun Fn204: A-Vib Sup Fn205: Vib Sup </pre>	  	Press the  Key to view the main menu for the utility function mode. Use the  or  Key to move through the list, select Fn203.
2	<pre> — Status Display — OnePrmTun— Pn103=00300 </pre>		Press the  Key to display the moment of inertia ratio set in Pn103 at present. To change the setting, move the cursor with the  or  Key and change the set value with the  or  Key. Note: If the display does not switch and “NO-OP” is displayed, take corrective action after checking the items given in 5.5.1 (1) <i>Before Performing One-parameter Tuning</i> .
3	<pre> BB —OnePrmTun— Setting Tuning Mode = 2 Type = 2 </pre>		Press the  Key to display the initial setting screen for one-parameter tuning.
4	<pre> BB —OnePrmTun— Setting Tuning Mode = 2 Type = 2 </pre>	  	Press the  ,  or  Key and set the items in steps 4-1 and 4-2.
4-1	■Tuning Mode Selection Select the tuning Mode. Select the tuning mode 0 or 1. Tuning Mode = 0: Makes adjustments giving priority to stability. Tuning Mode = 1: Makes adjustments giving priority to responsiveness. Tuning Mode = 2: Makes adjustments for positioning. Tuning Mode = 3: Makes adjustments for positioning, giving priority to overshooting suppression.		
4-2	■Type Selection Select the type according to the machine element to be driven. If there is noise or the gain does not increase, better results may be obtained by changing the rigid type. Type = 1: For belt drive mechanisms. Type = 2: For ball screw drive mechanisms [Factory setting]. Type = 3: For rigid systems, such as a gear.		
5			Input a servo ON command from the host controller. The display will change from “BB” to “RUN.”
6	<pre> RUN —OnePrmTun— Pn100=0040.0 Pn101=0020.00 Pn102=0040.0 </pre>		Press the  Key to display the set value.











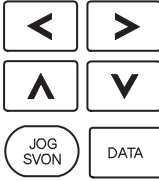





(cont'd)

Step	Display after Operation	Keys	Operation
7	<pre> RUN -OnePrmTun- LEVEL = 0050 NF1 NF2 ARES </pre>		<p>Adjust the responsiveness by changing the level. After pressing the  Key, the present level will be displayed. Move the cursor with the  or  Keys and adjust the level with  or  Keys, and press the  Key.</p> <p>The higher the level, the greater the responsiveness will be. If the value is too large, however, vibration will occur.</p> <p>If that occurs, press the  Key. The SERVOPACK will automatically detect the vibration frequencies and make notch filter or anti-resonance control settings.</p> <p>When the notch filter is set, “NF1” or “NF2” will be displayed on the bottom row.</p> <p>When anti-resonance control is set, “ARES” is displayed.</p> <p>Note: If the vibration is great, the vibration frequency will be detected even if the  Key is not pressed and a notch filter or anti-resonance control will be set.</p>
8	<pre> RUN -OnePrmTun- Pn100=0050.0 Pn101=0016.0 Pn102=0050.0 </pre>		<p>Press the  Key. A confirmation screen is displayed after level adjustment.</p>
9	<pre> RUN -OnePrmTun- Pn100=0050.0 Pn101=0016.0 Pn102=0050.0 </pre>		<ul style="list-style-type: none"> • Press the  Key. The adjusted values will be written to the SERVOPACK. “DONE” will be displayed for approx. 2 seconds, and then “RUN” will be displayed. • Not to save the values set in step 7, press the  Key. • The screen in step 7 will appear with the  Key.
10	<pre> RUN -FUNCTION- Fn202: Ref-AAT Fn203: OnePrmTun Fn204: A-Vib Sup Fn205: Vib Sup </pre>		<p>Press the  Key to complete the one-parameter tuning operation. The screen in step 1 will appear again.</p>

(2) Setting the Tuning Mode to 2 or 3

Step	Display after Operation	Keys	Operation
1	<pre> RUN —FUNCTION— Fn202:Ref-AAT Fn203:OnePrmTun Fn204:A-Vib Sup Fn205:Vib Sup </pre>	  	<p>Press the  Key to view the main menu for the utility function mode.</p> <p>Use the  or  Key to move through the list, select Fn203.</p>
2	<pre> Status Display  —OnePrmTun— Pn103=00300 </pre>		<p>Press the  Key to display the moment of inertia ratio set in Pn103 at present. To change the setting, move the cursor with the  or  Key and change the set value with the  or  Key.</p> <p>Note: If the display does not switch and “NO-OP” is displayed, take corrective action after checking the items given in 5.5.1 (1) <i>Before Performing One-parameter Tuning</i>.</p>
3	<pre> BB —OnePrmTun— Setting Tuning Mode = 2 Type = 2 </pre>		<p>Press the  Key to display the initial setting screen for one-parameter tuning.</p>
4	<pre> BB —OnePrmTun— Setting Tuning Mode = 2 Type = 2 </pre>	  	<p>Press the ,  or  Key and set the items in steps 4-1 and 4-2.</p>
4-1	<p>■Tuning Mode Selection</p> <p>Select the tuning Mode. Select the tuning mode 2 or 3.</p> <p>Tuning Mode = 0: Makes adjustments giving priority to stability.</p> <p>Tuning Mode = 1: Makes adjustments giving priority to responsiveness.</p> <p>Tuning Mode = 2: Makes adjustments for positioning.</p> <p>Tuning Mode = 3: Makes adjustments for positioning, giving priority to overshooting suppression.</p>		
4-2	<p>■Type Selection</p> <p>Select the type according to the machine element to be driven.</p> <p>If there is noise or the gain does not increase, better results may be obtained by changing the rigid type.</p> <p>Type = 1: For belt drive mechanisms.</p> <p>Type = 2: For ball screw drive mechanisms [Factory setting].</p> <p>Type = 3: For rigid systems, such as a gear.</p>		
5			<p>Input an servo ON command from the host controller. The display will change from “BB” to “RUN.”</p>
6	<pre> RUN —OnePrmTun— Pn100=0040.0 Pn101=0020.00 Pn141=0050.0 </pre>		<p>Press the  Key to display the set value.</p>

(cont'd)

Step	Display after Operation	Keys	Operation
7	<pre> RUN —OnePrmTun— FF LEVEL=0050.0 FB LEVEL=0040.0 NF1 NF2 ARES </pre>		<p>Adjust the responsiveness by changing the FF and FB levels.</p> <p>Press the  Key to display the present level. Move the cursor with the  Key and change the set value with the  or  Keys.</p> <p>After the setting is changed, press the  Key.</p> <p>The higher the level, the greater the responsiveness will be. If the value is too large, however, vibration will occur.</p> <p>If that occurs, press the  Key. The SERVOPACK will automatically detect the vibration frequencies and make notch filter or anti-resonance control settings. When the notch filter is set, “NF1” or “NF2” will be displayed on the bottom row.</p> <p>When the anti-resonance control is set, “ARES” is displayed.</p> <p>Notes:</p> <ul style="list-style-type: none"> • If the vibration is great, the vibration frequency will be detected even if the  Key is not pressed and a notch filter or anti-resonance control will be set. • The higher the FF level, the shorter the positioning time will be. If the level is too high, however, overshooting will occur. • If the FF level is changed when the servomotor is stopped and no reference is input, this new value will be effective, and the servomotor’s responsiveness will be changed. To safely adjust the FF level, wait until all operations have been completed and check the responsiveness. When the FF level is changed largely, vibration may occur because the responsiveness is changed rapidly. • The message, “FF LEVEL”, blinks until the machine reaches the effective FF level. If the servomotor does not stop approximately 10 seconds after the FF level is changed, the setting is no longer effective and will automatically return to the previous setting. • If the vibration is too small, the SERVOPACK may not automatically detect the vibration frequencies. If so, press the  Key to forcibly start the detection.
8	<pre> RUN —OnePrmTun— Pn100=0040.0 Pn101=0020.00 Pn141=0050.0 NF1 </pre>		<p>Press the  Key. A confirmation screen is displayed after level adjustment.</p>
9	<pre> RUN —OnePrmTun— Pn100=0040.0 Pn101=0020.00 Pn141=0050.0 NF1 </pre>		<ul style="list-style-type: none"> • Press the  Key. The adjusted values will be written to the SERVOPACK, “DONE” will be displayed for approx. 2 seconds, and then “RUN” will be displayed. • Not to save the values set in step 7, press the  Key. <p>The screen in step 7 will appear with the  Key.</p>
10	<pre> RUN —FUNCTION— Fn202:Ref-AAT Fn203:OnePrmTun Fn204:A-Vib Sup Fn205:Vib Sup </pre>		<p>Press the  Key to complete the one-parameter tuning operation. The screen in step 1 will appear again.</p>

(3) Related Functions

This section describes functions related to one-parameter tuning.

■ Notch Filter

Usually, set this function to Auto Setting. (The notch filter is factory-set to Auto Setting.)

If this function is set to Auto Setting, vibration will be detected automatically and the notch filter will be set.

Set this function to Not Auto Setting only if you do not change the notch filter setting before executing one-parameter tuning.

Parameter		Function	When Enabled	Classification
Pn460	n.□□□0	Does not set the 1st notch filter automatically.	Immediately	Tuning
	n.□□□1	Sets the 1st notch filter automatically. [Factory setting]		
	n.□0□□	Does not set the 2nd notch filter automatically.		
	n.□1□□	Sets the 2nd notch filter automatically. [Factory setting]		

■ Anti-Resonance Control Adjustment Function

This function reduces low vibration frequency; which the notch filter does not detect.

Usually, set this function to Auto Setting. (The anti-resonance control is factory-set to Auto Setting.)

When this function is set to Auto Setting, vibration will be automatically detected during one-parameter tuning and anti-resonance control will be automatically adjusted and set.

Parameter		Function	When Enabled	Classification
Pn160	n.□□0□	Does not use the anti-resonance control automatically.	After restart	Tuning
	n.□□1□	Uses the anti-resonance control automatically. [Factory setting]		

“ARES” will blink on the digital operator when anti-resonance control adjustment function is set.

```

RUN      —OnePrmTun—
FF LEVEL = 0050
FB LEVEL = 0040

NF1 NF2  ARES

```

■ Friction Compensation

This function compensates for changes in the following conditions.

- Changes in the viscous resistance of the lubricant, such as the grease, on the sliding parts of the machine
- Changes in the load resistance resulting from fluctuations in the machine assembly
- Secular changes in the load resistance

Conditions to which friction compensation is applicable depend on the tuning mode. The friction compensation setting in Pn408.3 applies when the mode is 0 or 1.

Friction Compensation Selecting		Mode			
		Tuning Mode = 0	Tuning Mode = 1	Tuning Mode = 2	Tuning Mode = 3
Pn408	n.0□□□ [Factory setting]	Adjusted without the friction compensation function.	Adjusted without the friction compensation function.	Adjusted with the friction compensation function.	Adjusted with the friction compensation function.
	n.1□□□	Adjusted with the friction compensation function.	Adjusted with the friction compensation function.		

■ Feedforward



IMPORTANT

- Model following control is used to make optimum feedforward settings in the servo. Therefore, model following control from the host controller is not used together with either the speed feedforward input or torque feedforward input. An improper speed feedforward input or torque feedforward input may result in overshooting.





If Pn140 is set to the factory setting and the mode setting is changed to 2 or 3, the feedforward gain (Pn109) (refer to 5.9.1) will be lost.

The following settings are required if model following control is used from the host controller (through the command option module) together with speed feedforward input or torque feedforward input.

Parameter		Function	When Enabled	Classification
Pn140	n.0□□□	Model following control is not used together with speed/torque feedforward input. [Factory setting]	Immediately	Tuning
	n.1□□□	Model following control is used together with speed/torque feedforward input.		

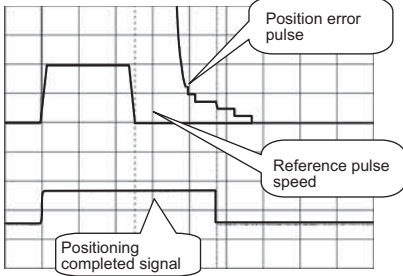
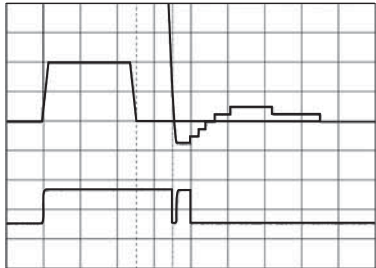
5.5.3 One-parameter Tuning Example

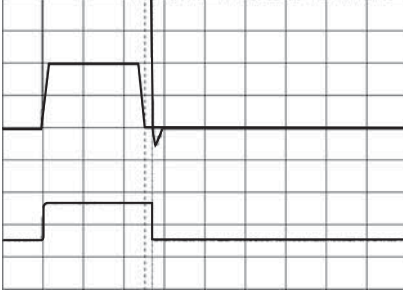
The following procedure is used for one-parameter tuning on the condition that the tuning mode is set to 2, or 3. This mode is used to reduce positioning time.

Step	Measuring Instrument Display Example	Operation
1	 <p>The graph shows three signals over time. The top signal is a trapezoidal pulse labeled 'Reference pulse speed'. The middle signal is a step function labeled 'Positioning completed signal'. The bottom signal is a curve labeled 'Position error pulse' that starts at a high value and decays to zero as the reference pulse is active.</p>	<p>Measure the positioning time after setting the moment of inertia ratio (Pn103) correctly. Tuning will be completed if the specifications are met here. Save the tuning results in the SERVOPACK.</p>
2	 <p>The graph shows the same three signals as in Step 1, but the 'Positioning completed signal' pulse is narrower, indicating a shorter positioning time.</p>	<p>The positioning time will become shorter if the FF level is increased. The tuning will be completed if the specifications are met. Save the tuning results in the SERVOPACK. If overshooting occurs before the specifications are met, go to step 3.</p>
3	 <p>The graph shows the same three signals as in Step 2, but the 'Position error pulse' curve shows less overshoot at the end of the reference pulse.</p>	<p>Overshooting will be reduced if the FB level is increased. If the overshooting is solved, go to step 4.</p>
4	 <p>The graph shows the same three signals as in Step 3, but the 'Position error pulse' curve shows significant overshoot and oscillation (vibration) at the end of the reference pulse.</p>	<p>The graph shows overshooting generated with the FF level increased in step 3. In this state, the overshooting occurs, but the positioning setting time is short. The tuning will be completed if the specifications are met. Save the adjustment results in the SERVOPACK. If overshooting occurs before the specifications are met, repeat steps 3 and 4.</p> <p>If vibration occurs before the overshooting is eliminated, suppress the vibration by the notch filter and anti-resonance control.</p> <p>Note: The vibration frequencies may not be detected if the vibration is too small. If that occurs, press the  Key to forcibly detect the vibration frequencies.</p>
5		<p>Save the adjustment results in the SERVOPACK.</p>

5.5.4 Related Parameters

The following parameters are set automatically by using one-parameter tuning. Manual adjustments are not required.

Parameter	Name
Pn100	Speed Loop Gain
Pn101	Speed Loop Integral Time Constant
Pn102	Position Loop Gain
Pn121	Friction Compensation Gain
Pn123	Friction Compensation Coefficient
Pn124	Friction Compensation Frequency Correction
Pn125	Friction Compensation Gain Correction
Pn141	Model Following Control Gain
Pn143	Model Following Control Bias (Forward Direction)
Pn144	Model Following Control Bias (Reverse Direction)
Pn147	Model Following Control Speed Feedforward Compensation
Pn161	Anti-Resonance Frequency
Pn163	Anti-Resonance Damping Gain
Pn401	1st Step 1st Torque Reference Filter Time Constant
Pn408	Notch Filter Selection/Friction Compensation Selection
Pn409	1st Notch Filter Frequency
Pn40A	1st Notch Filter Q Value
Pn40C	2nd Notch Filter Frequency
Pn40D	2nd Notch Filter Q Value

5.6 Anti-resonance Control Adjustment Function (Fn204)

This section describes how to adjust the anti-resonance control.

5.6.1 Anti-resonance Control Adjustment Function

The anti-resonance control adjustment function increases the effectiveness of the vibration suppression after one-parameter tuning.

The anti-resonance control adjustment function (Pn204) is an effective way to control the frequent vibration between 100 Hz and 1000 Hz when the control gain increases.

Perform one-parameter tuning (Fn203) or use another method to increase the responsiveness after performing this function. If the vibration gain is increased with one-parameter tuning performed, vibration may result again. If that occurs, perform this function again to fine-tune the settings.

CAUTION

- If this function is executed, related parameters will be set automatically. Therefore, there will be a large response change after this function is enabled or disabled. Enable the function in a state where the machine can come to an emergency stop at any time to ensure the safety operation of the machine.
- Be sure to set a suitable value for the moment of inertia ratio (Pn103) using advanced autotuning before executing the anti-resonance control adjustment function. If the setting greatly differs from the actual moment of inertia ratio, normal control of the SERVOPACK may not be possible, and vibration may result.



IMPORTANT

- This function detects vibration between 100 and 1,000 Hz. Vibration will not be detected for frequencies outside of this range, and instead, "F----" will be displayed. If that occurs, use one-parameter tuning with tuning mode 2 selected to automatically set a notch filter or use the vibration suppression function (Fn205).
- Vibration can be reduced more effectively by increasing the present damping gain (Pn163). The amplitude of vibration may become larger if the damping gain is excessively high. Increase the vibration gain from about 0% to 200% in 10% increments while checking the effect of vibration reduction. If the effect of vibration reduction is still insufficient at a gain of 200%, cancel the setting, and lower the control gain using a different method, such as one-parameter tuning.

(1) Before Performing Anti-Resonance Control Adjustment Function

Check the following settings before performing anti-resonance control adjustment function.

- a) A message (NO-OP) indicating that no operations are possible will be displayed, if all of the following conditions are not met.
 - The tuning-less function must not be enabled.
 - Test without motor function must not be enabled. (Pn00C.0=0)
 - Torque control must not be selected.
- b) Observe the following condition to ensure operation.
 - The write prohibited setting (Fn010) must not be set.

5.6.2 Anti-resonance Control Adjustment Function Operating Procedure

With this function, a control reference is sent, and the function is executed while vibration is occurring.

Anti-resonance control adjustment function is performed from the Digital Operator (option) or SigmaWin+.











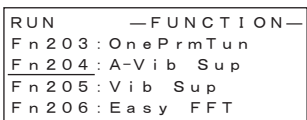

The following three methods can be used for the anti-resonance control adjustment function. Select and use the best method.

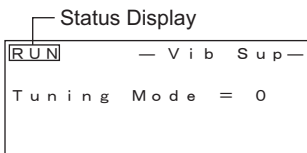
1. With Undetermined Vibration Frequency Before Adjusting the Anti-resonance Control
2. With Determined Vibration Frequency Before Adjusting the Anti-resonance Control
3. For Fine-tuning After Adjusting the Anti-resonance Control

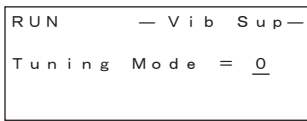



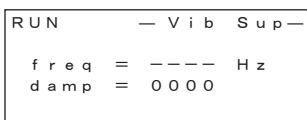

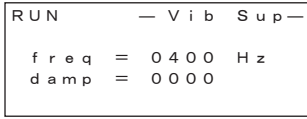
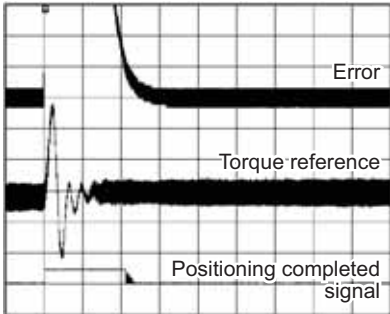













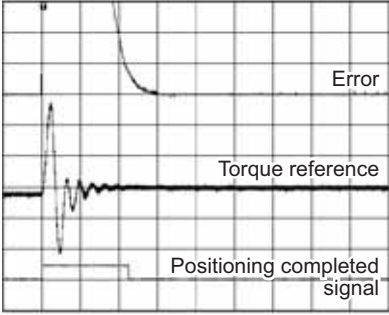



The operating procedures from the Digital Operator are described here.

Refer to the *Σ-V series User's Manual, Operation of Digital Operator (SIEP S80000 55)* for basic key operations of the Digital Operator.























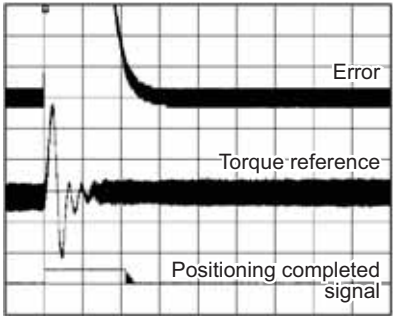

(1) With Undetermined Vibration Frequency Before Adjusting the Anti-resonance Control

Step	Display after Operation	Keys	Operation
1			Press the  Key to view the main menu for the utility function mode. Use the  or  Key to move through the list, select Fn204.
2			Press the  Key to display the initial setting screen for tuning mode. Note: If the display does not switch and “NO-OP” is displayed, take corrective action after checking the items given in 5.6.1 (1) Before Performing Anti-resonance Control Adjustment Function.
3			Press the  or  Key and select the tuning mode “0”.
4			Press the  Key while “Tuning Mode = 0” is displayed. The screen shown on the left will appear. The detection of vibration frequencies will start and “freq” will blink. Return to step 3 if vibration is not detected. Note: If a vibration is not detected even though a vibration has occurred, lower the vibration detection sensibility (Pn311). When this parameter is lowered, the detection sensitivity will be increased. Vibration may not be detected accurately if too small value is set.
5			The vibration frequency will be displayed if vibration is detected.  Waveform











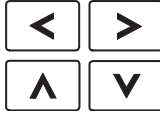

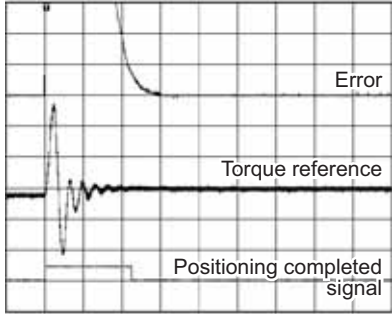

(cont'd)

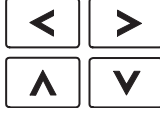
Step	Display after Operation	Keys	Operation
6	<pre> RUN - Vib Sup - freq = 0400 Hz damp = 0000_ </pre>		Press the  Key. The cursor will move to “damp,” and the blinking of “freq” will stop.
7	<pre> RUN - Vib Sup - freq = 0400 Hz damp = 0120_ </pre>	   	Move the cursor with the  or  Keys and press the  or  Keys to set the damping gain.  <p style="text-align: center;">Waveform</p> <p>Note: Increase the damping gain from about 0% to 200% in 10% increments while checking the effect of vibration reduction. If vibration reduction is still insufficient at a gain of 200%, cancel the setting, and lower the control gain by using a different method, such as one-parameter tuning.</p>
8	<pre> RUN - Vib Sup - freq = 0400 Hz damp = 0120_ </pre>		If fine-tuning of the frequency is necessary, press the  Key. The cursor will move from “damp” to “freq”. If fine-tuning is not necessary, skip step 9 and go to step 10.
9	<pre> RUN - Vib Sup - freq = 0420 Hz damp = 0120_ </pre>	   	Move the cursor with the  or  Keys and press the  or  Keys to fine-tune the frequency.
10	<pre> RUN - Vib Sup - freq = 0420 Hz damp = 0120_ </pre>		Press  Key to save the settings. “DONE” will blink for approx. 2 seconds and “RUN” will be displayed.
11	<pre> RUN -FUNCTION- Fn203: OnePrmTun Fn204: A-Vib Sup Fn205: Vib Sup Fn206: Easy FFT </pre>		Press the  Key to complete the anti-resonance control adjustment function. The screen in step 1 will appear again.

































(2) With Determined Vibration Frequency Before Adjusting the Anti-resonance Control

Step	Display after Operation	Keys	Operation
1	<pre> RUN -FUNCTION- Fn203: OnePrmTun Fn204: A-Vib Sup Fn205: Vib Sup Fn206: Easy FFT </pre>	  	<p>Press the  Key to view the main menu for the utility function mode.</p> <p>Use the  or  Key to move through the list, select Fn204.</p>
2	<pre> RUN -Vib Sup- Tuning Mode = 0 </pre>		<p>Press the  Key to display the initial setting screen for tuning mode.</p> <p>Note: If the display does not switch and “NO-OP” is displayed, take corrective action after checking the items given in 5.6.1 (1) Before Performing Anti-Resonance Control Adjustment Function.</p>
3	<pre> RUN -FUNCTION- Tuning Mode = 1 </pre>	 	<p>Press the  or  Key and select the tuning mode “1”.</p>
4	<pre> RUN -Vib Sup- freq = 0100 Hz damp = 0000 </pre>		<p>Press the  Key while “Tuning Mode = 1” is displayed. The screen shown on the left will appear and “freq” will blink.</p>  <p style="text-align: center;">Waveform</p>
5	<pre> RUN -Vib Sup- freq = 0100 Hz damp = 0000 </pre>	   	<p>Move the cursor with the  or  Keys and press the  or  Keys to adjust the frequency.</p>
6	<pre> RUN -Vib Sup- freq = 0400 Hz damp = 000<u>0</u> </pre>		<p>Press the  Key. The cursor will move to “damp”.</p>

(cont'd)

Step	Display after Operation	Keys	Operation
7	<pre> RUN - Vib Sup - freq = 0400 Hz damp = 0020 </pre>		<p>Move the cursor with the  or  Key and press the  or  Key to adjust the damping gain.</p>  <p>Waveform</p> <p>Note: Increase the damping gain from about 0% to 200% in 10% increments while checking the effect of vibration reduction. If vibration reduction is still insufficient at a gain of 200%, cancel the setting, and lower the control gain by using a different method, such as one-parameter tuning.</p>
8	<pre> RUN - Vib Sup - freq = 0400 Hz damp = 0120 </pre>		<p>If fine-tuning of the frequency is necessary, press the  Key. The cursor will move from “damp” to “freq”. If fine-tuning is not necessary, skip step 9 and go to step 10.</p>
9	<pre> RUN - Vib Sup - freq = 0400 Hz damp = 0120 </pre>		<p>Move the cursor with  or  Keys and press the  or  Keys to fine-tune the frequency.</p>
10	<pre> RUN - Vib Sup - freq = 0400 Hz damp = 0120 </pre>		<p>Press  Key to save the settings. “DONE” will blink for approx. 2 seconds and “RUN” will be displayed.</p>
11	<pre> RUN -FUNCTION- Fn203:OnePrmTun Fn204:A-Vib Sup Fn205:Vib Sup Fn206:Easy FFT </pre>		<p>Press the  Key to complete the anti-resonance control adjustment function. The screen in step 1 will appear again.</p>

(3) For Fine-tuning After Adjusting the Anti-resonance Control

Step	Display after Operation	Keys	Operation
1	<pre> RUN —FUNCTION— Fn203: OnePrmTun Fn204: A-Vib Sup Fn205: Vib Sup Fn206: Easy FFT </pre>	  	<p>Press the  Key to view the main menu for the utility function mode.</p> <p>Use the  or  Key to move through the list, select Fn204.</p>
2	<pre> RUN —FUNCTION— Tuning Mode = 1 </pre>		<p>Press the  Key to display the “Tuning Mode = 1” as shown on the left.</p> <p>Note: If the display does not switch and “NO-OP” is displayed, take corrective action after checking the items given in 5.6.1 (1) Before Performing Anti-Resonance Control Adjustment Function.</p>
3	<pre> RUN —Vib Sup— freq = 0400 Hz damp = 0120 </pre>		<p>Press the  Key while “Tuning Mode = 1” is displayed. The screen shown on the left will appear and “damp” will blink.</p>
4	<pre> RUN —Vib Sup— freq = 0400 Hz damp = 01<u>5</u>0 </pre>	   	<p>Move the cursor with the  or  Keys and press the  or  Keys to set the damping gain.</p> <p>Note: Increase the damping gain from about 0% to 200% in 10% increments while checking the effect of vibration reduction. If vibration reduction is still insufficient at a gain of 200%, cancel the setting, and lower the control gain by using a different method, such as one-parameter tuning.</p>
5	<pre> RUN —Vib Sup— freq = 0400 Hz damp = 0150 </pre>		<p>If fine-tuning of the frequency is necessary, press the  Key. The cursor will move from “damp” to “freq”. If fine-tuning is not necessary, skip step 6 and go to step 7.</p>
6	<pre> RUN —Vib Sup— freq = 04<u>2</u>0 Hz damp = 0150 </pre>	   	<p>Select a digit with  or  Keys, and press the  or  Keys to fine-tune the frequency.</p>
7	<pre> RUN —Vib Sup— freq = 0420 Hz damp = 015<u>0</u> </pre>		<p>Press  Key to save the settings. “DONE” will blink for approx. 2 seconds and “RUN” will be displayed.</p>
8	<pre> RUN —FUNCTION— Fn203: OnePrmTun Fn204: A-Vib Sup Fn205: Vib Sup Fn206: Easy FFT </pre>		<p>Press the  Key to complete the anti-resonance control adjustment function. The screen in step 1 will appear again.</p>

5.6.3 Related Parameters

Pn160 and Pn161 are set automatically. The other parameters are not set automatically but the respective set values in the parameters will apply.

Parameter	Name
Pn160	Anti-resonance Control Related Switch
Pn161	Anti-resonance Frequency
Pn162	Anti-resonance Gain Compensation
Pn163	Anti-resonance Damping Gain
Pn164	Anti-resonance Filter Time Constant 1 Compensation
Pn165	Anti-resonance Filter Time Constant 2 Compensation

5.7 Vibration Suppression Function (Fn205)

This section describes the vibration suppression function.

5.7.1 Vibration Suppression Function

The vibration suppression function suppresses transitional vibration at frequency as low as 1 to 100 Hz that is generated mainly when positioning if the machine stand vibrates.

This function is set automatically when advanced autotuning or advanced autotuning by reference is executed. In most cases, this function is not necessary. Use this function only if fine-tuning is required or readjustment is required as a result of a failure to detect vibration.

Perform one-parameter tuning (Fn203) or use another method to increase the responsiveness after performing this function.

CAUTION

- If this function is executed, related parameters will be set automatically. Therefore, the response before and after using this function may vary greatly. Enable the function in a state where the machine can come to an emergency stop at any time to ensure the safety operation of the machine.
- Be sure to set a suitable value for the moment of inertia ratio (Pn103) using advanced autotuning before executing this function. If the setting greatly differs from the actual moment of inertia ratio, normal control of the SERVOPACK may not be possible, and vibration may result.



IMPORTANT

- This function detects vibration frequency between 1 to 100 Hz. Vibration will not be detected for frequencies outside of this range, and instead, "F-----" will be displayed.
- Frequency detection will not be performed if no vibration results from position error or the vibration frequencies are outside the range of detectable frequencies. If so, use a device, such as a displacement sensor or vibration sensor, to measure the vibration.
- If vibration frequencies automatically detected are not suppressed, the actual frequency and the detected frequency may differ. Fine-tune the detected frequency if necessary.

(1) Before Performing Vibration Suppression Function

Check the following settings before performing the vibration suppression function.

- a) A message (NO-OP) indicating that no operations are possible will be displayed, if all of the following conditions are not met.
 - The control must be set to position control.
 - The tuning-less function must not be enabled.
 - Test without motor function must not be enabled. (Pn00C.0 = 0)
- b) Observe the following condition to ensure operation.
 - The write prohibited setting (Fn010) must not be set.

(2) Items Influencing Performance

If continuous vibration occurs when the motor is not rotating, the vibration suppression function cannot be used to suppress the vibration effectively. If the result is not satisfactory, perform anti-resonance control adjustment function (Fn204) or one-parameter tuning (Fn203).

(3) Detection of Vibration Frequencies

No frequency detection may be possible if the vibration does not appear as a position error or the vibration resulting from the position error is too small.

The detection sensitivity can be adjusted by changing the setting for the remained vibration detection width (Pn560) which is set in accordance with the value of the positioning completed width (Pn522). Perform the detection of vibration frequencies after adjusting the remained vibration detection width (Pn560).

Pn560	Remained Vibration Detection Width Position				Classification
	Setting Range	Setting Unit	Factory Setting	When Enabled	
	1 to 3000	0.1%	400	Immediately	Setup

Note: Use a set value of 10% as a guideline. The smaller the set value is, the higher the detection sensitivity will be. If the value is too small, however, the vibration may not be detected accurately.

Vibration frequencies automatically detected may vary more or less during each positioning operation. Perform positioning several times and make adjustments while checking the effect of vibration suppression.

5.7.2 Vibration Suppression Function Operating Procedure

The following procedure is used for vibration suppression function.

Vibration suppression function is performed from the Digital Operator (option) or SigmaWin+.

The operating procedure from the Digital Operator is described here.

For basic operations of the Digital Operator, refer to the *Σ-V series User's Manual, Operation of Digital Operator* (SIEP S800000 55).







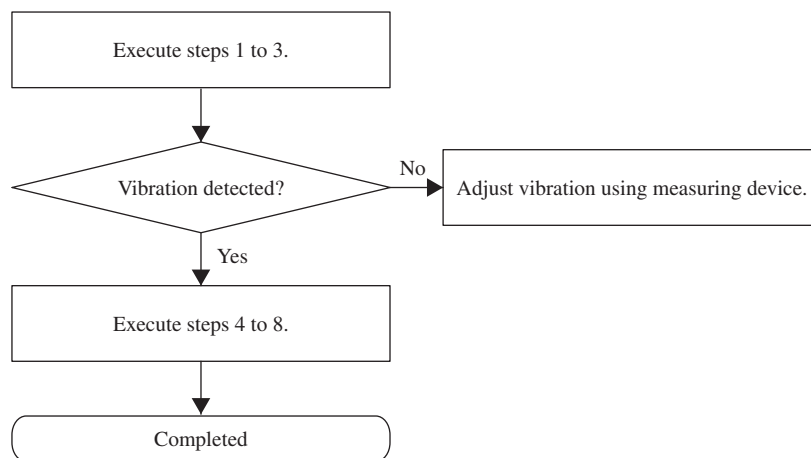









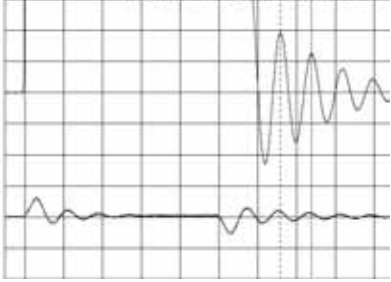

Note: If this function is aborted by pressing the  Key, the SERVOPACK will continue operating until the motor comes to a stop. After the motor stops, the set value will return to the previous value.

The operating flow of the vibration suppression function is shown below.







(1) Operating Flow

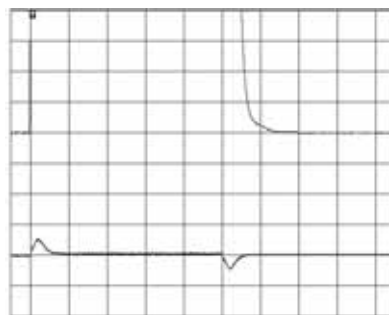

(2) Operating Procedure

Step	Display after Operation	Keys	Operation
1	Input a control reference and take the following steps while repeating positioning.		
2	<pre> RUN -FUNCTION- Fn204:A-Vib Sup Fn205:Vib Sup Fn206:Easy FFT Fn207:V-Monitor </pre>	  	<p>Press the  Key to view the main menu for the utility function mode.</p> <p>Use the  or  Key to move through the list, select Fn205.</p>
3	<pre> RUN -Vib Sup- Measure f=-----Hz Setting f=050.0Hz </pre>		<p>Press the  Key. The display shown on the left will appear.</p> <p>Measure f: Measurement frequency Setting f: Setting frequency [Factory-set to the set value for Pn145]</p> <p>Notes:</p> <ul style="list-style-type: none"> If the setting frequency and actual operating frequency are different, "Setting" will blink. The detected vibration frequency will be displayed. <pre> RUN -Vib Sup- Measure f=010.4Hz Setting f=050.0Hz </pre> <ul style="list-style-type: none"> Frequency detection will not be performed if there is no vibration or the vibration frequency is outside the range of detectable frequencies. The following screen will be displayed if vibration is not detected. If the vibration frequencies are not detected, prepare a means of detecting and measuring the vibration. When the vibration frequencies are measured, go to step 5 and manually set the measured vibration frequency. <pre> RUN -Vib Sup- Measure f=-----Hz Setting f=050.0Hz </pre>
4	<pre> RUN -Vib Sup- Measure f=010.4Hz Setting f=010.4Hz </pre>		<p>Press the  Key. The displayed "Measure f" value will be displayed as the "Setting f" value as well.</p>  <p style="text-align: center;">Waveform</p>
5	<pre> RUN -Vib Sup- Measure f=010.4Hz Setting f=012.4Hz </pre>	   	<p>If the vibration is not completely suppressed, press the  or  Key to move the cursor, and press the  or  Key to fine-tune the frequency. Skip this step and go to step 7 if the fine-tuning of the frequency is not necessary.</p> <p>Note: If the setting frequency and actual operating frequency are different, "Setting" will blink.</p>

(cont'd)

Step	Display after Operation	Keys	Operation
6	<pre> RUN -Vib Sup- Measure f=010.4Hz Setting f=012.4Hz </pre>		<p>Press the  Key. The “Setting f” will change to usual display and the frequency currently displayed will be set for the vibration suppression function.</p> 
7	<pre> RUN -Vib Sup- Measure f =----Hz Setting f =012.4Hz </pre>		<p>Press the  Key to save the settings. “DONE” will blink for approx. 2 seconds and “RUN” will be displayed.</p>
8	<pre> RUN -FUNCTION- Fn204 Fn205 Fn206 Fn207 </pre>		<p>Press the  Key to complete the vibration suppression function. The screen in step 1 will appear again.</p>



IMPORTANT

No settings related to the vibration suppression function will be changed during operation.

If the motor does not stop approximately 10 seconds after the setting changes, a timeout error will result and the previous setting will be enabled again.

The vibration suppression function will be enabled when the parameter is set in step 6. The motor response, however, will change when the motor comes to a stop with no reference input.

(3) Related Function

This section describes a function related to vibration suppression.

■ Feedforward



IMPORTANT

- Model following control is used to make optimum feedforward settings in the servo. Therefore, model following control from the host controller is not used together with either the speed feedforward input or torque feedforward input. An improper speed feedforward input or torque feedforward input may result in overshooting.

If this function is performed, the feedforward reference (Pn109) will be ignored because model following control will be enabled.

The following settings are required if model following control is used from the host controller (through the command option module) together with speed feedforward input or torque feedforward input.

Parameter	Function	When Enabled	Classification
Pn140	n.0□□□	Immediately	Tuning
	n.1□□□		

5.7.3 Related Parameters

The following parameters are set automatically by using vibration suppression function. Manual adjustments are not required.

Parameter	Name
Pn140	Model Following Control Related Switch
Pn141	Model Following Control Gain
Pn145	Vibration Suppression 1 Frequency A
Pn146	Vibration Suppression 1 Frequency B

5.8 Additional Adjustment Function

This section describes the functions that can be used for additional fine tuning after making adjustments with advanced autotuning, advanced autotuning by references, or one-parameter tuning.

- Switching gain settings
- Friction compensation
- Current Control Mode Selection
- Current Gain Level Setting
- Speed Detection Method Selection

5.8.1 Switching Gain Settings

Two gain switching functions are available, manual switching and automatic switching. The manual switching function uses an external input signal to switch gains, and the automatic switching function switches gains automatically.

Parameter	Function	When Enabled	Classification
Pn139	n.□□□0	Immediately	Tuning
	n.□□□2		

Note: n.□□□1 is reserved. Do not set.

For the gain combinations for switching, refer to (1) *Gain Combinations for Switching*.

For the manual gain switching, refer to the manual of the connected command option module.

For the automatic gain switching, refer to (3) *Automatic Gain Switching*.

(1) Gain Combinations for Switching

Setting	Speed Loop Gain	Speed Loop Integral Time Constant	Position Loop Gain	Torque Reference Filter	Model Following Control Gain	Model Following Control Gain Compensation	Friction Compensation Gain
Gain Setting 1	Pn100 Speed Loop Gain	Pn101 Speed Loop Integral Time Constant	Pn102 Position Loop Gain	Pn401 1st step 1st Torque Reference Filter Time Constant	Pn141* Model Following Control Gain	Pn142* Model Following Control Gain Compensation	Pn121 Friction Compensation Gain
Gain Setting 2	Pn104 2nd Speed Loop Gain	Pn105 2nd Speed Loop Integral Time Constant	Pn106 2nd Position Loop Gain	Pn412 1st step 2nd Torque Reference Filter Time Constant	Pn148* 2nd Model Following Control Gain	Pn149* 2nd Model Following Control Gain Compensation	Pn122 2nd Gain for Friction Compensation

* The switching gain settings for the model following control gain and the model following control gain compensation are available only for manual gain switching. To enable the gain switching of these parameters, a gain switching input signal must be sent, and the following conditions must be met.

- No command being executed.
- Motor having been completely stopped.

If these conditions are not satisfied, the applicable parameters will not be switched although the other parameters shown in this table will be switched.

(2) Manual Gain Switching

Manual gain switching uses a command (/G-SEL1) from the command option module to switch between gain setting 1 and gain setting 2.

For details, refer to the manual of the connected command option module.

(3) Automatic Gain Switching

Automatic gain switching is performed under the following settings and conditions.

Parameter Setting	Switching Setting	Setting	Switching Wait Time	Switching Time
Pn139 = n.□□□2 (Automatic Switching)	Condition A established.	Gain Setting 1 to Gain Setting 2	Gain Switching Waiting Time 1 Pn135	Gain Switching Time 1 Pn131
	Condition A not established.	Gain Setting 2 to Gain Setting 1	Gain Switching Waiting Time 2 Pn136	Gain Switching Time 2 Pn132

Select one of the following setting for switching condition A.

Parameter		Switching Condition A		When Enabled	Classification
		Position Control	Other than Position Control		
Pn139	n.□□0□	Positioning completed signal (/COIN) ON	Fixed in gain setting 1	Immediately	Tuning
	n.□□1□	Positioning completed signal (/COIN) OFF	Fixed in gain setting 2		
	n.□□2□	Near signal mapping (/NEAR) ON	Fixed in gain setting 1		
	n.□□3□	Near signal mapping (/NEAR) OFF	Fixed in gain setting 2		
	n.□□4□	No output for position reference filter and reference pulse input OFF	Fixed in gain setting 1		
	n.□□5□	Position reference pulse input ON	Fixed in gain setting 2		

Automatic switching pattern 1 (Pn139.0 = 2)

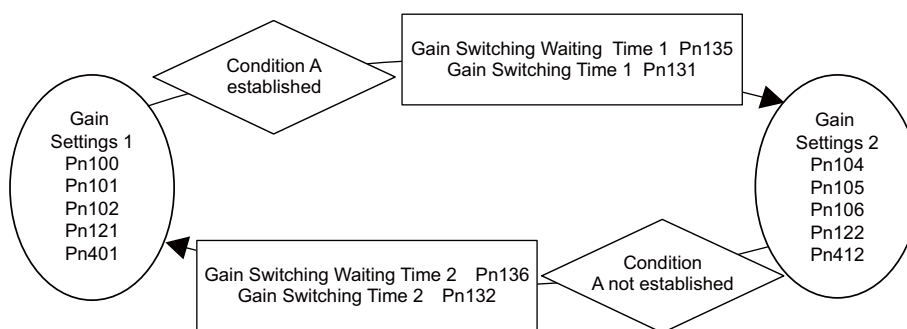

■ Relationship between the Gain Switching Waiting Time and the Switching Time Constant

In this example, the “positioning completed signal (/COIN) ON” condition is set as condition A for automatic gain switching. The position loop gain is switched from the value in Pn102 (Position Loop Gain) to the value in Pn106 (2nd Position Loop Gain). When the /COIN signal goes ON, the switching operation begins after the waiting time set in Pn135. The switching operation changes the position loop gain linearly from Pn102 to Pn106 over the switching time set in Pn131.

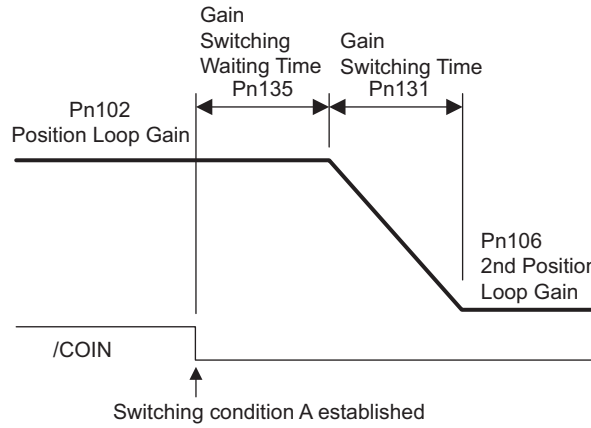

Note: Automatic gain switching is available in the PI and I-P controls. (Pn10B)

(4) Related Parameters

Pn100	Speed Loop Gain Speed Position				Classification
	Setting Range	Setting Unit	Factory Setting	When Enabled	
	10 to 20000	0.1 Hz	400	Immediately	Tuning
Pn101	Speed Loop Integral Time Constant Speed Position				Classification
	Setting Range	Setting Unit	Factory Setting	When Enabled	
	15 to 51200	0.01 ms	2000	Immediately	Tuning
Pn102	Position Loop Gain Position				Classification
	Setting Range	Setting Unit	Factory Setting	When Enabled	
	10 to 20000	0.1/s	400	Immediately	Tuning
Pn141	Model Following Control Gain Position				Classification
	Setting Range	Setting Unit	Factory Setting	When Enabled	
	10 to 20000	0.1/s	500	Immediately	Tuning
Pn142	Model Following Control Gain Compensation Position				Classification
	Setting Range	Setting Unit	Factory Setting	When Enabled	
	500 to 2000	0.1%	1000	Immediately	Tuning
Pn104	2nd Speed Loop Gain Speed Position				Classification
	Setting Range	Setting Unit	Factory Setting	When Enabled	
	10 to 20000	0.1 Hz	400	Immediately	Tuning
Pn105	2nd Speed Loop Integral Time Constant Speed Position				Classification
	Setting Range	Setting Unit	Factory Setting	When Enabled	
	15 to 51200	0.01 ms	2000	Immediately	Tuning
Pn106	2nd Position Loop Gain Position				Classification
	Setting Range	Setting Unit	Factory Setting	When Enabled	
	10 to 20000	0.1/s	400	Immediately	Tuning
Pn121	Friction Compensation Gain Speed Position				Classification
	Setting Range	Setting Unit	Factory Setting	When Enabled	
	10 to 1000	0.1%	100	Immediately	Tuning
Pn122	2nd Gain for Friction Compensation Speed Position				Classification
	Setting Range	Setting Unit	Factory Setting	When Enabled	
	10 to 1000	1%	100	Immediately	Tuning
Pn148	2nd Model Following Control Gain Position				Classification
	Setting Range	Setting Unit	Factory Setting	When Enabled	
	10 to 20000	0.1/s	500	Immediately	Tuning
Pn149	2nd Model Following Control Gain Compensation Position				Classification
	Setting Range	Setting Unit	Factory Setting	When Enabled	
	500 to 2000	0.1 %	1000	Immediately	Tuning
Pn412	1st step 2nd Torque Reference Filter Time Constant Speed Position Torque				Classification
	Setting Range	Setting Unit	Factory Setting	When Enabled	
	0 to 65535	0.01 ms	100	Immediately	Tuning

(5) Parameters for Automatic Gain Switching

Pn131	Gain Switching Time 1 Position				Classification
	Setting Range	Setting Unit	Factory Setting	When Enabled	
	0 to 65535	1 ms	0	Immediately	Tuning
Pn132	Gain Switching Time 2 Position				Classification
	Setting Range	Setting Unit	Factory Setting	When Enabled	
	0 to 65535	1 ms	0	Immediately	Tuning
Pn135	Gain Switching Waiting Time 1 Position				Classification
	Setting Range	Setting Unit	Factory Setting	When Enabled	
	0 to 65535	1 ms	0	Immediately	Tuning
Pn136	Gain Switching Waiting Time 2 Position				Classification
	Setting Range	Setting Unit	Factory Setting	When Enabled	
	0 to 65535	1 ms	0	Immediately	Tuning

(6) Related Monitor

Monitor No. (Un)	Name	Value	Remarks
Un014	Effective gain monitor	1	For gain setting 1
		2	For gain setting 2

Note: When using the tuning-less function, gain setting 1 is enabled.

Parameter	Analog Monitor	Name	Output Value	Remarks
Pn006	n.□□0B	Active gain	1 V	Gain setting 1 is enabled.
Pn007			2 V	Gain setting 2 is enabled.

5.8.2 Friction Compensation

Friction compensation rectifies the viscous friction change and regular load change.

The factors causing load changes include grease viscosity resistance changes resulting from temperature changes in addition to viscous friction and regular load changes resulting from equipment variations and secular changes.

Friction compensation is automatically adjusted by the following settings.

1. The advanced autotuning level is set to mode 2 or 3.
2. The one-parameter tuning mode is set to 2 or 3.

Refer to the following description and make adjustments only if manual adjustment is required.

(1) Required Parameter Settings

The following parameter settings are required to use friction compensation.

Parameter	Function	When Enabled	Classification
Pn408	n.0□□□	Immediately	Setup
	n.1□□□		

Pn121	Friction Compensation Gain Speed Position				Classification
	Setting Range	Setting Unit	Factory Setting	When Enabled	
	10 to 1000	1 %	100	Immediately	Tuning
Pn123	Friction Compensation Coefficient Speed Position				Classification
	Setting Range	Setting Unit	Factory Setting	When Enabled	
	0 to 100	1 %	0	Immediately	Tuning
Pn124	Friction Compensation Frequency Correction Speed Position				Classification
	Setting Range	Setting Unit	Factory Setting	When Enabled	
	-10000 to 10000	0.1 Hz	0	Immediately	Tuning
Pn125	Friction Compensation Gain Correction Speed Position				Classification
	Setting Range	Setting Unit	Factory Setting	When Enabled	
	1 to 1000	1 %	100	Immediately	Tuning

(2) Operating Procedure for Friction Compensation

The following procedure is used for friction compensation.

 CAUTION
<p>Before using friction compensation, set the moment of inertia ratio (Pn103) as correctly as possible. If the wrong moment of inertia ratio is set, vibration may result.</p>

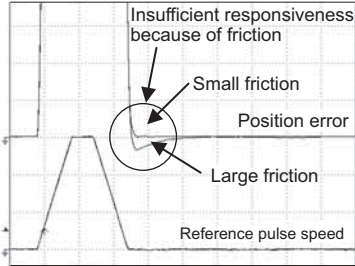
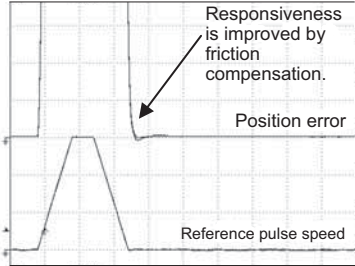
Step	Operation
1	<p>Set the following parameters for friction compensation to the factory setting as follows. Friction compensation gain (Pn121): 100 Friction compensation coefficient (Pn123): 0 Friction compensation frequency correction (Pn124): 0 Friction compensation gain correction (Pn125): 100 Note: Always use the factory-set values for friction compensation frequency correction (Pn124) and friction compensation gain correction (Pn125).</p>
2	<p>To check the effect of friction compensation, increase the friction compensation coefficient (Pn123). Note: Normally, set the upper limit of the friction compensation coefficient (Pn123) to 95% max.</p>
3	<p>If the friction compensation is insufficient in step 2, increase the set value in Pn121 to where the equipment does not vibrate. Note: The SERVOPACK may vibrate if Pn121 is set to a value the same as or higher than the resonance frequency of the equipment. If necessary, adjust Pn121 in increments of 10%.</p> <p>Effect of Adjustment The following graph shows the responsiveness with and without proper adjustment.</p> <div style="display: flex; justify-content: space-around; align-items: flex-start;"> <div style="text-align: center;">  <p>Without friction compensation</p> </div> <div style="text-align: center;">  <p>With friction compensation</p> </div> </div> <p>Effect of Adjustment Parameters</p> <p>Pn121: Friction Compensation Gain This parameter sets the responsiveness for external disturbance. The higher the set value is, the better the responsiveness will be. If the equipment has a resonance frequency, however, vibration may result if the set value is the same as or high than the resonance frequency.</p> <p>Pn123: Friction Compensation Coefficient This parameter sets the effect of friction compensation. The higher the set value is, the more effective friction compensation will be. If the set value is excessively high, however, the vibration will occur easily. Usually, set the value to 95% or less.</p>

5.8.3 Current Control Mode Selection

This function reduces high-frequency noises while the motor is being stopped. This function is enabled by default and set to be effective under different application conditions.

Input Voltage	Applicable SERVOPACK Model SGD-
200 V	120A□□A, 180A□□A, 200A□□A, 330A□□A, 470A□□A, 550A□□A, 590A□□A, 780A□□A
400 V	3R5D□□A, 5R4D□□A, 8R4D□□A, 120D□□A, 170D□□A, 210D□□A, 260D□□A, 280D□□A, 370D□□A

Parameter	Meaning	When Enabled	Classification
Pn009	n. □□0□	After restart	Tuning
	n. □□1□		



IMPORTANT

- When this function is executed, the load ratio may increase while the servomotor is being stopped.

5.8.4 Current Gain Level Setting

This function reduces noises by adjusting the parameter value for current control inside the SERVOPACK according to the speed loop gain (Pn100). The noise level can be reduced by reducing the current gain level (Pn13D) from its factory setting of 2000% (disabled). If the set value of Pn13D is decreased, the level of noise will be lowered, but the response characteristics of the SERVOPACK will also be degraded. Adjust the current gain level within the allowable range at which SERVOPACK response characteristics can be secured.

Pn13D	Current Gain Level				Classification
	Setting Range	Setting Unit	Factory Setting	When Enabled	
	100 to 2000	1 %	2000	Immediately	Tuning



IMPORTANT

- If the parameter setting of the current gain level is changed, the responsiveness characteristic of the speed loop will also change. The servo must, therefore, be readjusted again.

5.8.5 Speed Detection Method Selection

This function can ensure smooth movement of the motor while the motor is running. This function is disabled by default. Set the value of Pn009.2 = 1 to enable this function.

Parameter	Meaning	When Enabled	Classification
Pn009	n. □0□□	After restart	Tuning
	n. □1□□		



IMPORTANT

- If this function is changed, the responsiveness characteristic of the speed loop will also change. The servo must, therefore, be readjusted again.

5.9 Compatible Adjustment Function

The Σ -V series SERVOPACKs have the adjustment functions explained in sections 5.1 to 5.8 that can be used to make machine adjustments. This section explains compatible functions provided by earlier models, such as the Σ -III SERVOPACK.

5.9.1 Feedforward Reference

Applies feedforward control compensation in position control inside the SERVOPACK. Use this parameter to shorten positioning time.

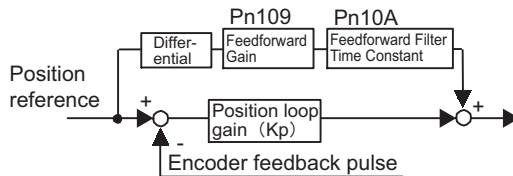

Pn109	Feedforward Gain Position				Classification
	Setting Range	Setting Unit	Factory Setting	When Enabled	
	0 to 100	1%	0	Immediately	Tuning
Pn10A	Feedforward Filter Time Constant Position				Classification
	Setting Range	Setting Unit	Factory Setting	When Enabled	
	0 to 6400	0.01 ms	0	Immediately	Tuning

If the Feedforward Gain (Pn109) is set to a value that is too high, the machine may vibrate. The gain setting should be set to a value less than 80%.

5.9.2 Using the Mode Switch (P/PI Switching)

Use the mode switch (P/PI switching) function in the following cases:

- To suppress overshooting during acceleration or deceleration (for speed control)
- To over overshooting during positioning and reduce the settling time (for position control)

P Control: Proportional control

PI Control: Proportional/integral control

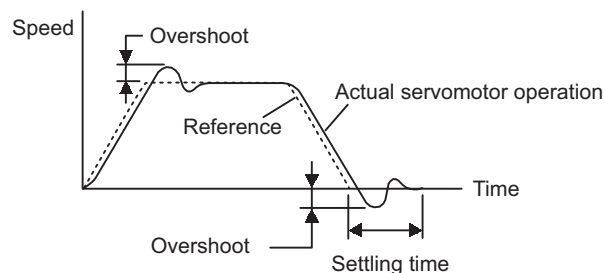

To enable the mode switch, set Pn10B.0 to 0 to 3. The mode switch changes the speed-control mode to PI (proportional/integral) control or P (proportional) control.

Notes:

- Monitoring the speed response waveform and position error waveform is required for adjustment.
- If I-P control is selected for speed loop control, the mode switching function will be disabled.

(1) Related Parameters

Select the conditions to switch modes (P or PI control switching) by using the following parameters.

Parameter	Mode Switch Selection	Parameter Containing Detection Point Setting	When Enabled	Classification	
Pn10B	n.□□□0	Uses a torque reference level for detection point. [Factory setting]	Pn10C	Immediately	Setup
	n.□□□1	Uses a speed reference level for detection point.	Pn10D		
	n.□□□2	Uses an acceleration level for detection point.	Pn10E		
	n.□□□3	Uses an position error pulse level for detection point.	Pn10F		
	n.□□□4	Does not use mode switch function.	—		

■ Parameters to set the detection point

Pn10C	Mode Switch (Torque Reference) Speed <input type="checkbox"/> Position <input type="checkbox"/>				Classification
	Setting Range	Setting Unit	Factory Setting	When Enabled	
	0 to 800	1%	200	Immediately	Tuning
Pn10D	Mode Switch (Speed Reference) Speed <input type="checkbox"/> Position <input type="checkbox"/>				Classification
	Setting Range	Setting Unit	Factory Setting	When Enabled	
	0 to 10000	1 min ⁻¹	0	Immediately	Tuning
Pn10E	Mode Switch (Acceleration) Speed <input type="checkbox"/> Position <input type="checkbox"/>				Classification
	Setting Range	Setting Unit	Factory Setting	When Enabled	
	0 to 30000	1 min ⁻¹ /s	0	Immediately	Tuning
Pn10F	Mode Switch (Position Error) Position <input type="checkbox"/>				Classification
	Setting Range	Setting Unit	Factory Setting	When Enabled	
	0 to 10000	1 reference unit	0	Immediately	Tuning

Mode switch functions according to the detection point are as follows.

■ Using the Torque Reference Level to Switch Modes (Factory Setting)

With this setting, the speed loop is switched to P control when the value of torque reference input exceeds the torque set in Pn10C. The factory setting for the torque reference detection point is 200% of the rated torque.

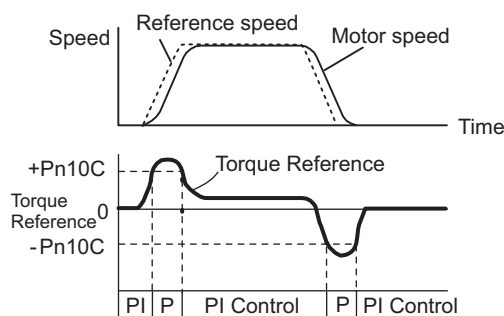

<Example>

If the mode switch function is not being used and the SERVOPACK is always operated with PI control, the speed of the motor may overshoot due to torque saturation during acceleration or deceleration. The mode switch function suppresses torque saturation and eliminates the overshooting of the motor speed.

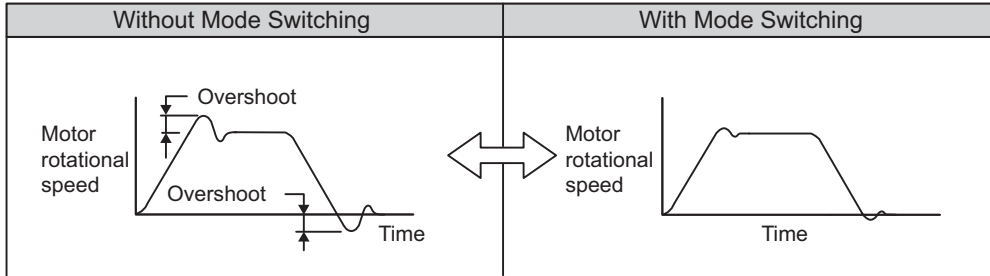

■ Using the Speed Reference Level to Switch Modes

With this setting, the speed loop is switched to P control when the value of speed reference input exceeds the speed set in Pn10D.

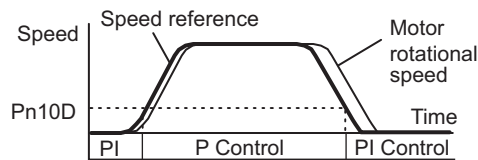

<Example>

In this example, the mode switch is used to reduce the settling time. It is necessary to increase the speed loop gain to reduce the settling time. Using the mode switch suppresses overshooting when speed loop gain is increased.

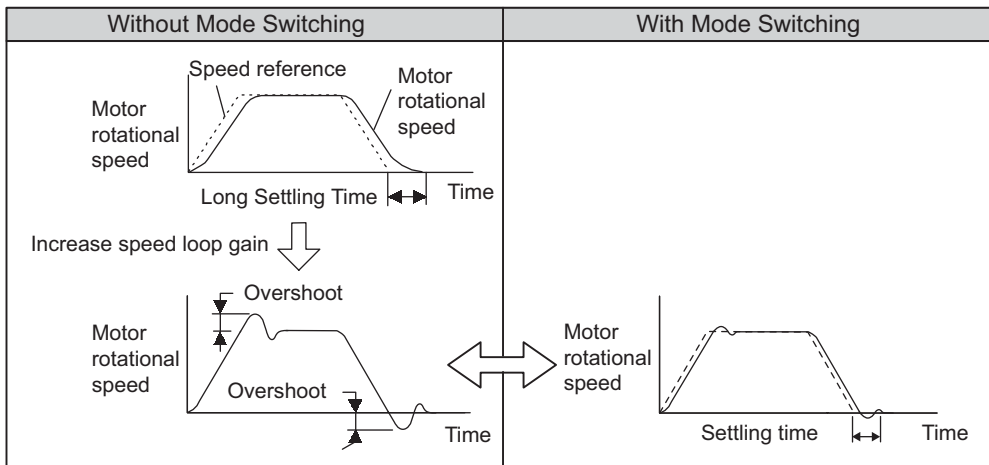

■ Using the Acceleration Level to Switch Modes

With this setting, the speed loop is switched to P control when the speed reference exceeds the acceleration rate set in Pn10E.

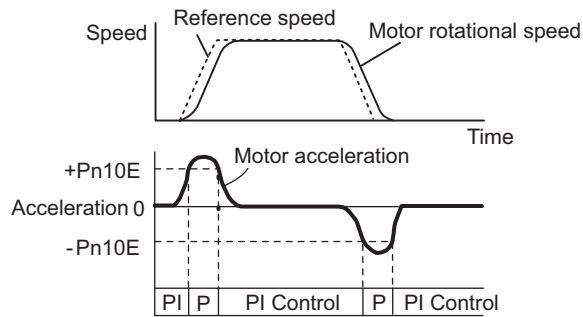

<Example>

If the mode switch function is not being used and the SERVOPACK is always operated with PI control, the speed of the motor may overshoot due to torque saturation during acceleration or deceleration. The mode switch function suppresses torque saturation and eliminates the overshooting of the motor rotational speed.

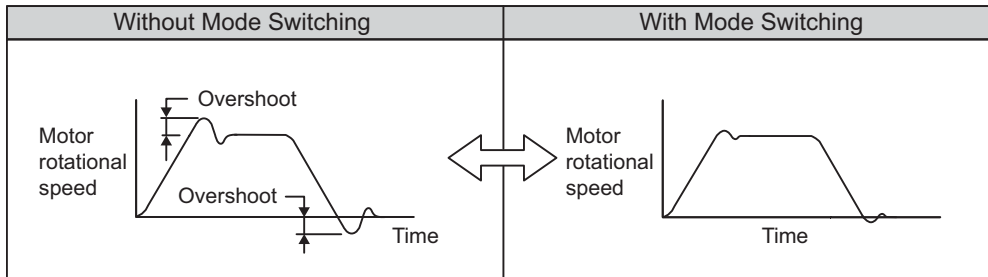

■ Using the Position Error Pulse Level to Switch Modes

With this setting, the speed loop is switched to P control when the position error pulse exceeds the value set in Pn10F.

This setting is effective with position control only.

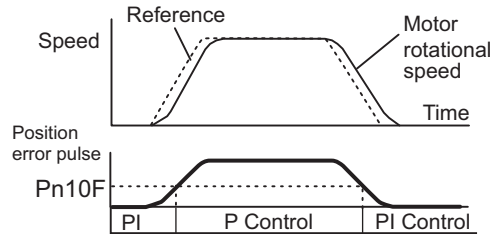

<Example>

In this example, the mode switch is used to reduce the settling time. It is necessary to increase the speed loop gain to reduce the settling time. Using the mode switch suppresses overshooting when speed loop gain is increased.

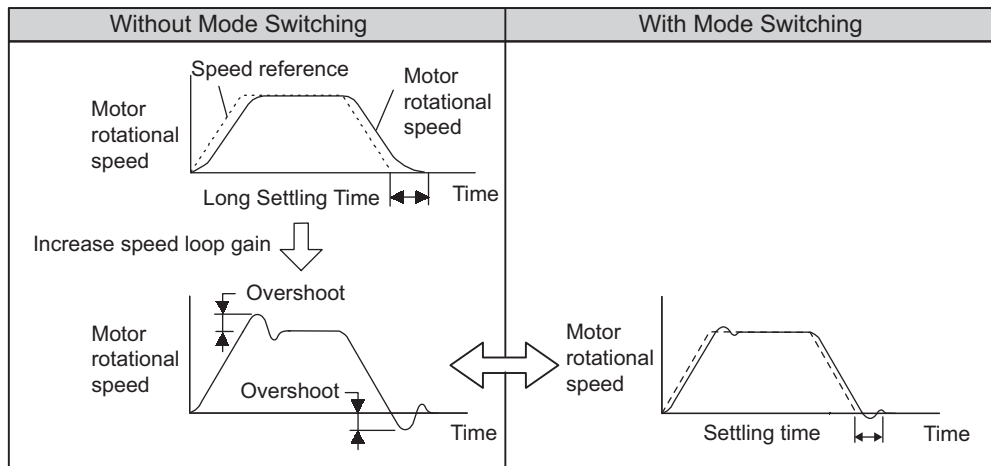

5.9.3 Torque Reference Filter

As shown in the following diagram, the torque reference filter contains first order lag filter and notch filters arrayed in series, and each filter operates independently. The notch filters can be enabled and disabled with the Pn408.

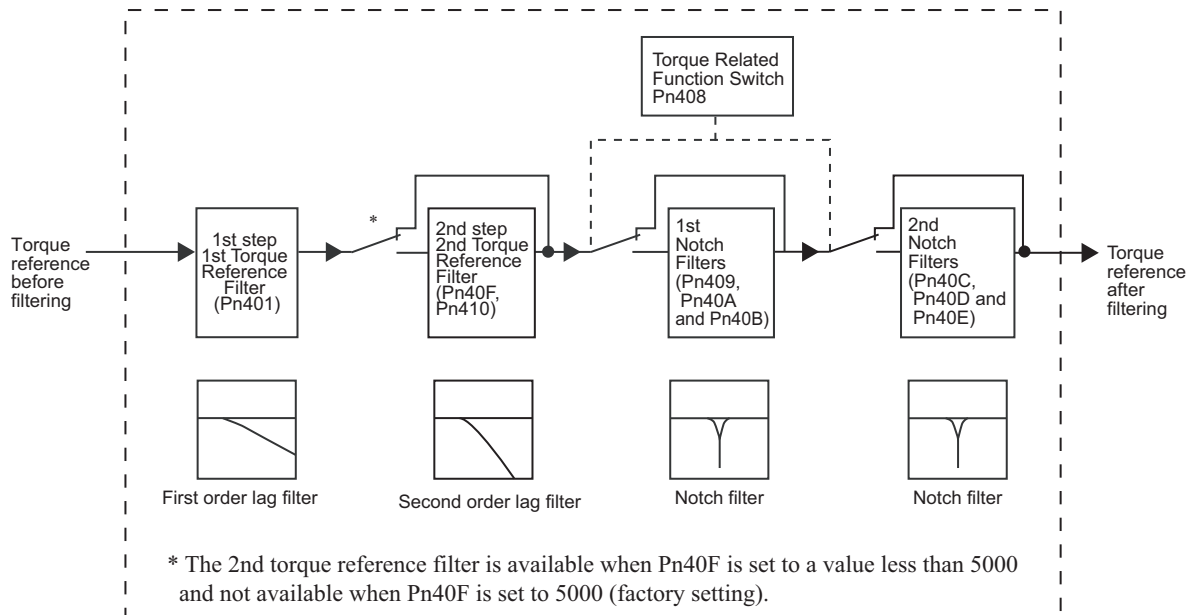

(1) Torque Reference Filter

If you suspect that machine vibration is being caused by the servo drive, try adjusting the filter time constants. This may stop the vibration. The lower the value, the better the speed control response will be, but there is a lower limit that depends on the machine conditions.

Pn401	1st Step 1st Torque Reference Filter Time Constant				Classification	
			Speed	Position		Torque
	Setting Range	Setting Unit	Factory Setting	When Enabled		
	0 to 65535	0.01 ms	100	Immediately	Tuning	

■ Torque Reference Filter Guide

- Use the speed loop gain (Pn100 [Hz]) and the torque filter time constant (Pn401 [ms]).
 Adjusted value for stable control: $Pn401 [ms] \leq 1000 / (2\pi \times Pn100 [Hz] \times 4)$
 Critical gains: $Pn401 [ms] < 1000 / (2\pi \times Pn100 [Hz] \times 1)$

Parameter	Meaning	When Enabled	Classification	
Pn408	n.□□□0	Disables 1st notch filter. [Factory setting]	Immediately	Tuning
	n.□□□1	Uses 1st notch filter.		
	n.□0□□	Disables 2nd notch filter. [Factory setting]		
	n.□1□□	Uses 2nd notch filter.		

Pn40C	2nd Notch Filter Frequency Speed Position Torque				Classification
	Setting Range	Setting Unit	Factory Setting	When Enabled	
	50 to 5000	1 Hz	5000	Immediately	Tuning
Pn40D	2nd Notch Filter Q Value Speed Position Torque				Classification
	Setting Range	Setting Unit	Factory Setting	When Enabled	
	50 to 1000	0.01	70	Immediately	Tuning
Pn40E	2nd Notch Filter Depth Speed Position Torque				Classification
	Setting Range	Setting Unit	Factory Setting	When Enabled	
	0 to 1000	0.001	0	Immediately	Tuning
Pn40F	2nd Step 2nd Torque Reference Filter Frequency Speed Position Torque				Classification
	Setting Range	Setting Unit	Factory Setting	When Enabled	
	100 to 5000	1 Hz	5000	Immediately	Tuning
Pn410	2nd Step 2nd Torque Reference Filter Q Value Speed Position Torque				Classification
	Setting Range	Setting Unit	Factory Setting	When Enabled	
	50 to 1000	0.01	50	Immediately	Tuning



IMPORTANT

- Sufficient precautions must be taken when setting the notch filter frequencies. Do not set the notch filter frequencies (Pn409 or Pn40C) that is close to the speed loop's response frequency. Set the frequencies at least four times higher than the speed loop's response frequency. Setting the notch filter frequency too close to the response frequency may cause vibration and damage the machine.
- Change the notch filter frequency (Pn409 or Pn40C) only when the motor is stopped. Vibration may occur if the notch filter frequency is changed when the motor is rotating.

5.9.4 Position Integral Time Constant

This function adds an integral control operation to the position loop. It is effective for electronic cam or electronic shaft applications.

Pn11F	Position Integral Time Constant Position				Classification
	Setting Range	Setting Unit	Factory Setting	When Enabled	
	0 to 50000	0.1 ms	0	Immediately	Tuning

Utility Functions (Fn□□□)

6.1 List of Utility Functions	6-2
6.2 Alarm History Display (Fn000)	6-3
6.3 JOG Operation (Fn002)	6-4
6.4 Origin Search (Fn003)	6-6
6.5 Program JOG Operation (Fn004)	6-8
6.6 Initializing Parameter Settings (Fn005)	6-13
6.7 Clearing Alarm History (Fn006)	6-14
6.8 Offset Adjustment of Analog Monitor Output (Fn00C)	6-15
6.9 Gain Adjustment of Analog Monitor Output (Fn00D)	6-17
6.10 Automatic Offset-Signal Adjustment of the Motor Current Detection (Fn00E)	6-19
6.11 Manual Offset-Signal Adjustment of the Motor Current Detection (Fn00F)	6-20
6.12 Write Prohibited Setting (Fn010)	6-21
6.13 Servomotor Model Display (Fn011)	6-23
6.14 Software Version Display (Fn012)	6-24
6.15 Resetting Configuration Error of Option Module (Fn014)	6-25
6.16 Vibration Detection Level Initialization (Fn01B)	6-26
6.17 Display of SERVOPACK and Servomotor ID (Fn01E)	6-28
6.18 Display of Servomotor ID in Feedback Option Module (Fn01F)	6-29
6.19 Origin Setting (Fn020)	6-30
6.20 Software Reset (Fn030)	6-31
6.21 EasyFFT (Fn206)	6-32
6.22 Online Vibration Monitor (Fn207)	6-36

6.1 List of Utility Functions

Utility functions are used to execute the functions related to servomotor operation and adjustment. Each utility function has a number starting with Fn.

The following table lists the utility functions and reference section.

Function No.	Function	Reference Section
Fn000	Alarm history display	6.2
Fn002	JOG operation	6.3
Fn003	Origin search	6.4
Fn004	Program JOG operation	6.5
Fn005	Initializing parameter settings	6.6
Fn006	Clearing alarm history	6.7
Fn008	Absolute encoder multi-turn reset and encoder alarm reset	4.5.4
Fn00C	Offset adjustment of analog monitor output	6.8
Fn00D	Gain adjustment of analog monitor output	6.9
Fn00E	Automatic offset-signal adjustment of motor current detection signal	6.10
Fn00F	Manual offset-signal adjustment of motor current detection signal	6.11
Fn010	Write prohibited setting	6.12
Fn011	Servomotor model display	6.13
Fn012	Software version display	6.14
Fn013	Multi-turn limit value setting change when a multi-turn limit disagreement alarm occurs	4.5.7
Fn014	Resetting configuration error of option module	6.15
Fn01B	Vibration detection level initialization	6.16
Fn01E	Display of SERVOPACK and servomotor ID	6.17
Fn01F	Display of servomotor ID in feedback option module	6.18
Fn020	Origin setting	6.19
Fn030	Software reset	6.20
Fn200	Tuning-less level setting	5.2.2
Fn201	Advanced autotuning	5.3.2
Fn202	Advanced autotuning by reference	5.4.2
Fn203	One-parameter tuning	5.5.2
Fn204	Anti-resonance control adjustment function	5.6.2
Fn205	Vibration suppression function	5.7.2
Fn206	EasyFFT	6.21
Fn207	Online vibration monitor	6.22

- Note 1. If the write prohibited setting (Fn010) is enabled, “NO-OP” is displayed on the status display of the digital operator if the user attempts to execute the above utility functions. To execute these utility functions, set Fn010 to write permitted. For details, refer to 6.12 *Write Prohibited Setting (Fn010)*.
2. If the utility functions given above are executed using SigmaWin+ or the option module, “NO-OP” will be displayed if an attempt is made to execute the utility function using the digital operator.

6.2 Alarm History Display (Fn000)

This function displays the alarm history to check the ten latest alarms.

The latest ten alarm numbers and time stamps* can be checked.

* Time Stamps

A function that measures the ON times of the control power supply and main circuit power supply in 100-ms units and displays the operating time when an alarm occurs. The time stamp operates around the clock for approximately 13 years.

<Example of Time Stamps>













If 36000 is displayed,

360000 [ms] = 3600 [s]

= 60 [min]

= 1 [h] Therefore, the total number of operating hours is 1.

Follow the steps below to confirm the alarm histories.

Step	Display Example	Keys	Description
1	<pre> BB -FUNCTION- Fn207: V-Monitor Fn000: Alm History Fn002: JOG Fn003: Z-Search </pre>	  	Press the  Key to open the Utility Function Mode main menu and select Fn000.
2	<pre> 0: D00 00001207196 1: 720 00000032651 2: 511 00000009043 3: --- </pre> <p>Alarm History No. "0" is the latest, "9" is the oldest.</p> <p>Alarm No. Time stamps</p>		Press the  Key. Then, the alarm history will appear.
3	<pre> A.D00 -ALARM- 0: D00 00001207196 1: 720 00000032651 2: 511 00000009043 3: --- </pre> <pre> A.D00 -ALARM- 1: 720 00000032651 2: 511 00000009043 3: --- 4: --- </pre> <pre> A.D00 -ALARM- 2: 511 00000009043 3: --- 4: --- 5: --- </pre>	 	Press the  or  Key to scroll through the alarm history.
4	<pre> BB -FUNCTION- Fn207: V-Monitor Fn000: Alm History Fn002: JOG Fn003: Z-Search </pre>		Press the  Key to return to the Utility Function Mode main menu.

<Notes>

- If the same alarm occurs again more than one hour later, a record of this alarm is also saved.
- The message "□: ___" indicates that no alarm occurs.
- Delete the alarm history using the parameter Fn006. The alarm history is not cleared on alarm reset or when the SERVOPACK power is turned OFF.

6.3 JOG Operation (Fn002)

JOG operation is used to check the operation of the servomotor under speed control without connecting the SERVOPACK to the host.

⚠ CAUTION

While the SERVOPACK is in JOG operation, the overtravel function will be disabled. Consider the operating range of the machine when performing JOG operation for the SERVOPACK.

(1) Settings before Operation

The following settings are required before performing JOG operation.



















- If a servo ON command is input, send a servo OFF command.
- Considering the operating range of the machine, set the JOG operation speed in Pn304.

Pn304	JOG Speed				Classification
	Setting Range	Setting Unit	Factory Setting	When Enabled	
	0 to 10000	1 min ⁻¹ *	500	Immediately	











* When using an SGMCS direct drive motor, the setting unit will be automatically changed to 0.1 min⁻¹

(2) Operating Procedure

Follow the steps below to set the JOG speed. The following example is given when the rotating direction of servomotor is set as Pn000.0 = 0 (Forward rotation by forward reference).

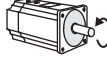
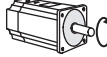
Step	Display Example	Keys	Description
1	<pre> BB -FUNCTION- Fn000: Alm History Fn002: JOG Fn003: Z-Search Fn004: Program JOG </pre>	  	Press the  Key to open the Utility Function Mode main menu and select Fn002.
2	<pre> BB -JOG- Pn304=00500 Un000= 00000 Un002= 00000 Un00D=00000000 </pre>		Press the  Key. The display is switched to the execution display of Fn002. Note: If the display is not switched and “NO-OP” is displayed in the status display, change the following settings. (Refer to 6.12.) • If Write Prohibited is set in Fn010: → Cancel the Write Prohibited setting. • If a servo ON command is input: → Send a servo OFF command.
3	<pre> BB -JOG- Pn304=0050<u>0</u> Un000= 00000 Un002= 00000 Un00D=00000000 </pre>		Press the  Key. The cursor moves to the setting side (the right side) of Pn304 (JOG speed).
4	<pre> BB -JOG- Pn304=01<u>0</u>00 Un000= 00000 Un002= 00000 Un00D=00000000 </pre>	   	Press the  or  Key and the  or  Key to set the JOG speed to 1000 min ⁻¹ .
5	<pre> BB -JOG- Pn304=01000 Un000= 00000 Un002= 00000 Un00D=00000000 </pre>		Press the  Key. The setting value is entered, and the cursor moves to the parameter number side (the left side).

(cont'd)

Step	Display Example	Keys	Description
6	<pre> RUN - JOG - Pn304=01000 Un000= 00000 Un002= 00000 Un00D=00000000 </pre>		<p>Press the  Key.</p> <p>“RUN” is displayed in the status display, and power is applied to the servomotor.</p>
7	<pre> RUN - JOG - Pn304=01000 Un000= 00000 Un002= 00000 Un00D=00000000 </pre>	 	<p>The servomotor will rotate at the present speed set in Pn304 while the  Key (for forward rotation) or  Key (for reverse rotation) is pressed.</p> <div style="display: flex; justify-content: space-around; align-items: center;"> <div style="text-align: center;">  <p>Forward</p> </div> <div style="text-align: center;">  <p>Reverse</p> </div> </div>
8	<pre> BB - JOG - Pn304=01000 Un000= 00000 Un002= 00000 Un00D=00000000 </pre>		<p>After having confirmed the correct motion of servomotor, press the  Key.</p> <p>“BB” is displayed in the status display, and power is not applied to the servomotor.</p>
9	<pre> BB - FUNCTION - Fn000: Alm History Fn002: JOG Fn003: Z-Search Fn004: Program JOG </pre>		<p>Press the  Key to return to the Utility Function Mode main menu.</p>
10	After JOG operation, turn OFF the power and then turn ON again.		

6.4 Origin Search (Fn003)

The origin search is designed to position the origin pulse position of the incremental encoder (phase-C) and to clamp at the position.

CAUTION

- Perform origin searches without connecting the coupling.
The forward run prohibited (P-OT) and reverse run prohibited (N-OT) signals are not effective in origin search mode.

This mode is used when the motor shaft needs to be aligned to the machine.

Motor speed at the time of execution: 60 min⁻¹

(For SGMCS direct drive motors, the speed at the time of execution is 6 min⁻¹)

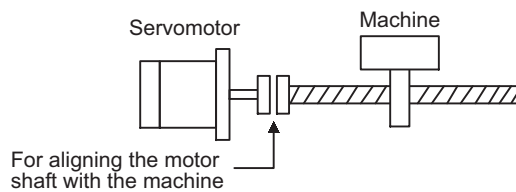









(1) Settings before Operation

The following settings are required before performing an origin search.

















- If a servo ON command is input, send a servo OFF command.

(2) Operating Procedure

Follow the steps below to execute the origin search.

Step	Display Example	Keys	Description
1	<pre> BB —FUNCTION— Fn002: JOG Fn003: Z-Search Fn004: Program JOG Fn005: Prm Init </pre>	  	Press the  Key to open the Utility Function Mode main menu and select Fn003.
2	<pre> BB —Z-Search— Un000= 00000 Un002= 00000 Un003=00774 Un00D=00000000 </pre>		Press the  Key. The display is switched to the execution display of Fn003. Note: If the display is not switched and “NO-OP” is displayed in the status display, change the following settings. (Refer to 6.12.) <ul style="list-style-type: none"> • If Write Prohibited is set in Fn010: → Cancel the Write Prohibited setting. • If a servo ON command is input: → Send a servo OFF command.
3	<pre> BB —Z-Search— Un000= 00000 Un002= 00000 Un003=00774 Un00D=00000000 </pre>		Press the  Key. “RUN” is displayed in the status display, and power is applied to the servomotor. Note: If the servomotor is already at the zero position, “-Complete-” is displayed.

(cont'd)

Step	Display Example	Keys	Description									
4	<pre> RUN -Complete- Un000= 00000 Un002= 00000 Un003=00000 Un00D=00001D58 </pre>	 	<p>Pressing the  Key will rotate the motor in the forward direction. Pressing the  Key will rotate the motor in the reverse direction. The rotation of the servomotor changes according to the setting of Pn000.0.</p> <table border="1"> <thead> <tr> <th>Parameter</th> <th> key (Forward)</th> <th> key (Reverse)</th> </tr> </thead> <tbody> <tr> <td>Pn000 n.□□□0</td> <td>CCW</td> <td>CW</td> </tr> <tr> <td>Pn000 n.□□□1</td> <td>CW</td> <td>CCW</td> </tr> </tbody> </table> <p>Note: Direction when viewed from the load of the servomotor.</p> <p>Press the  or  Key until the motor stops. If the origin search is completed normally, “-Complete-” is displayed on the right top on the screen.</p>	Parameter	 key (Forward)	 key (Reverse)	Pn000 n.□□□0	CCW	CW	Pn000 n.□□□1	CW	CCW
Parameter	 key (Forward)	 key (Reverse)										
Pn000 n.□□□0	CCW	CW										
Pn000 n.□□□1	CW	CCW										
5	<pre> BB -Z-Search- Un000= 00000 Un002= 00000 Un003=00774 Un00D=00001D58 </pre>		<p>When the origin search is completed, press the  Key.</p> <p>“BB” is displayed in the status display, and power will not be applied to the servomotor. The display “-Complete-” changes to “-Z-Search-.”</p>									
6	<pre> BB -FUNCTION- Fn002: JOG Fn003: Z-Search Fn004: Program JOG Fn005: Prm Init </pre>		<p>Press the  Key to return to the Utility Function Mode main menu.</p>									
7	After origin search operation, turn OFF the power and then turn ON again.											

6.5 Program JOG Operation (Fn004)

The Program JOG Operation is a utility function, that allows continuous automatic operation determined by the preset operation pattern, movement distance, movement speed, acceleration/deceleration time, waiting time, and number of time of movement.

This function can be used to move the servomotor without it having to be connected to a host controller for the machine as a trial operation in JOG operation mode. Program JOG Operation can be used to confirm the operation and for simple positioning operations.

(1) Settings before Operation

The following settings are required before performing a program JOG operation.

- Consider the machine operation range and safe operation when setting the movement distance and speed correctly.
- If a servo ON command has been input, send a servo OFF command.
- The main power is supplied.
- No alarm is detected.
- The overtravel does not occur.
- HWBB function is disable.

Note:

- The functions that are applicable for position control, such as position reference filter, can be used.
- The overtravel function is enabled in this function.

(2) Related Parametersf

Pn530	Program JOG Operation Related Switch Speed Position Torque				Classification
	Setting Range	Setting Unit	Factory Setting	When Enabled	
	0000 to 0005	–	0000	Immediately	Setup
Pn531	Program JOG Movement Distance Speed Position Torque				Classification
	Setting Range	Setting Unit	Factory Setting	When Enabled	
	1 to 1073741824	1 reference unit	32768	Immediately	Setup
Pn533	Program JOG Movement Speed Speed Position Torque				Classification
	Setting Range	Setting Unit	Factory Setting	When Enabled	
	1 to 10000	1 min ⁻¹ *	500	Immediately	Setup
Pn534	Program JOG Acceleration/Deceleration Time Speed Position Torque				Classification
	Setting Range	Setting Unit	Factory Setting	When Enabled	
	2 to 10000	1 ms	100	Immediately	Setup
Pn535	Program JOG Waiting Time Speed Position Torque				Classification
	Setting Range	Setting Unit	Factory Setting	When Enabled	
	0 to 10000	1 ms	100	Immediately	Setup
Pn536	Number of Times of Program JOG Movement Speed Position Torque				Classification
	Setting Range	Setting Unit	Factory Setting	When Enabled	
	0 to 1000	1 time	1	Immediately	Setup

* When using an SGMCS direct drive motor, the setting unit will be automatically changed to 0.1 min⁻¹

Parameter	Contents	Factory Setting	
Pn530	n.□□□0	(Waiting time Pn535 → Forward movement Pn531) × Number of times of movement Pn536	0
	n.□□□1	(Waiting time Pn535 → Reverse movement Pn531) × Number of times of movement Pn536	
	n.□□□2	(Waiting time Pn535 → Forward movement Pn531) × Number of times of movement Pn536 (Waiting time Pn535 → Reverse movement Pn531) × Number of times of movement Pn536	
	n.□□□3	(Waiting time Pn535 → Reverse movement Pn531) × Number of times of movement Pn536 (Waiting time Pn535 → Forward movement Pn531) × Number of times of movement Pn536	
	n.□□□4	(Waiting time Pn535 → Forward movement Pn531 → Waiting time Pn535 → Reverse movement Pn531) × Number of times of movement Pn536	
	n.□□□5	(Waiting time Pn535 → Reverse movement Pn531 → Waiting time Pn535 → Forward movement Pn531) × Number of times of movement Pn536	

Note: For details of Pn530, refer to (3) Setting Infinite Time Operation and (4) Program JOG Operation Patterns.

(3) Setting Infinite Time Operation

- When 0, 1, 4 or 5 is set to Pn530.0, setting 0 to Pn536 (Number of Times of Program JOG Movement) enables infinite time operation.
- Program JOG operation pattern follows the setting of Pn530.0. Only number of times of program JOG movement is infinite. For details, refer to (4) Program JOG Operation Patterns.
- To stop infinite time operation, press the JOG/SVON Key to turn the servomotor power OFF.

Note: 2 or 3 is set to Pn530.0, infinite time operation is disabled.
0 or 1 is set to Pn530.0, movement is one direction. Take note of movable range.

(4) Program JOG Operation Patterns

The following example is given when the rotating direction of the servomotor is set as Pn000.0 = 0 (Forward rotation by forward reference).

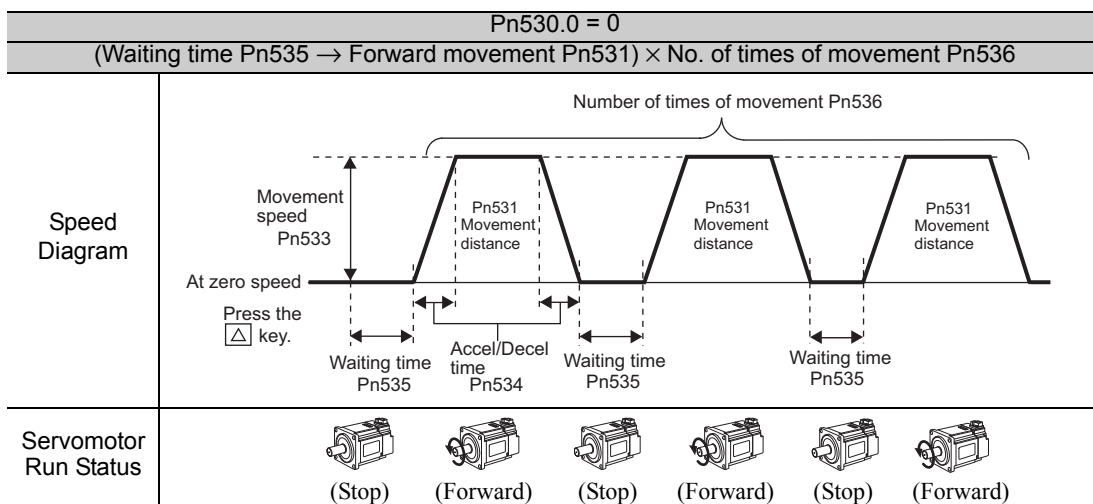

Pn530.0 = 1
 (Waiting time Pn535 → Reverse movement Pn531) × No. of times of movement Pn536

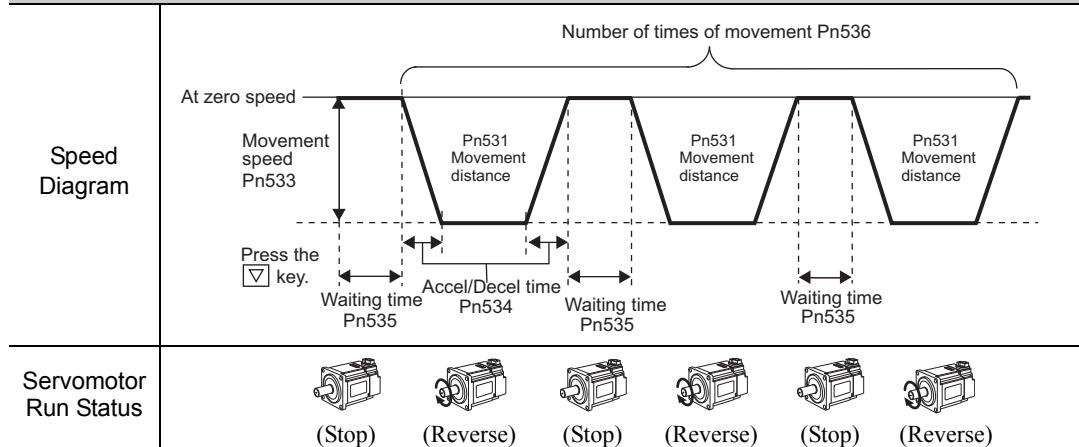

Pn530.0 = 2
 (Waiting time Pn535 → Forward movement Pn531) × No. of times of movement Pn536
 (Waiting time Pn535 → Reverse movement Pn531) × No. of times of movement Pn536

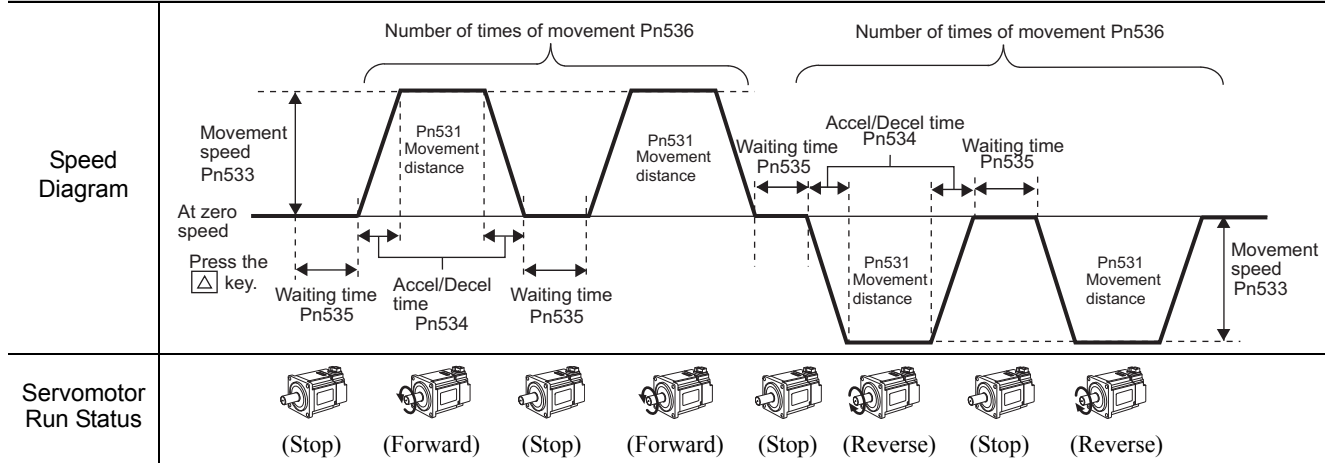

Pn530.0 = 3
 (Waiting time Pn535 → Reverse movement Pn531) × No. of times of movement Pn536
 (Waiting time Pn535 → Forward movement Pn531) × No. of times of movement Pn536

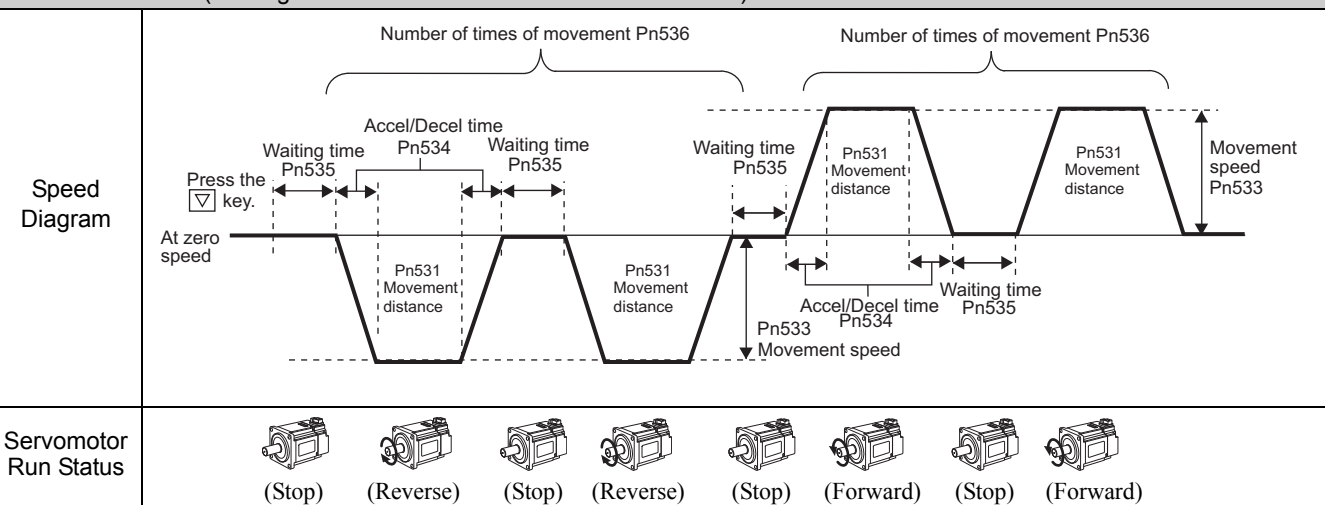

Note: When 3 is set to Pn530.0, infinite time operation is disabled.

Pn530.0 = 4
 (Waiting time Pn535 → Forward movement Pn531 → Waiting time Pn535 → Reverse movement Pn531)
 × No. of times of movement Pn536

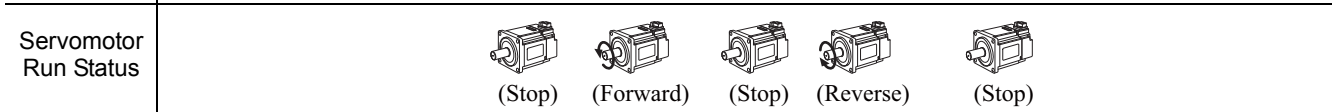
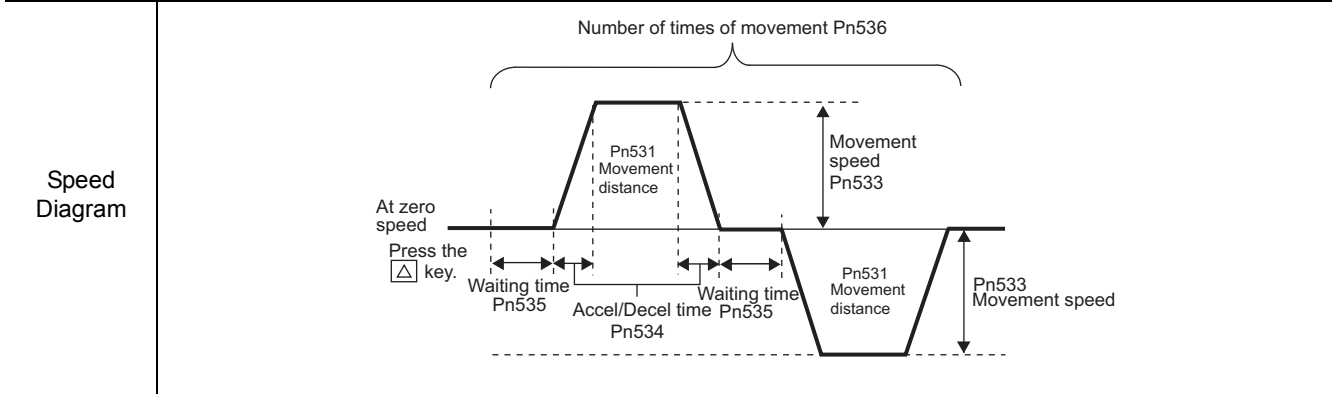



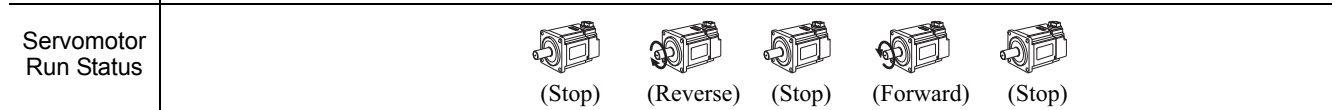
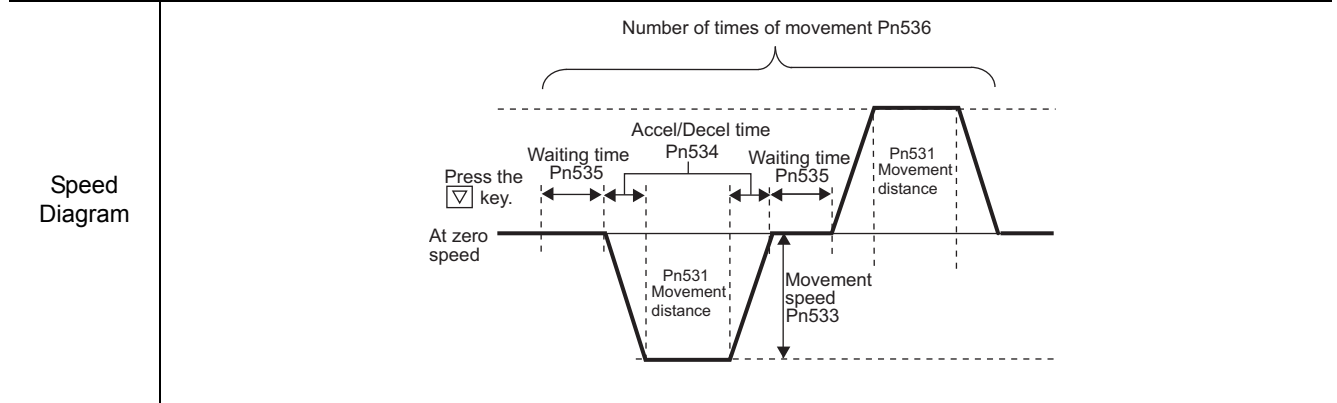



















Pn530.0 = 5
 (Waiting time Pn535 → Reverse movement Pn531 → Waiting time Pn535 → Forward movement Pn531)
 × No. of times of movement Pn536



(5) Operating Procedure

Follow the steps below to perform the program JOG operation after setting a program for JOG operation.









Step	Display Example	Keys	Description
1	<pre>BB -FUNCTION- Fn003: Z-Search Fn004: Program JOG Fn005: Prm Init Fn006: AlmHist Clr</pre>	  	Press the  Key to open the Utility Function Mode main menu and select Fn004.
2	<pre>BB -PRG JOG- Pn531=00032768 Pn533=00500 Pn534=00100 Pn536=00001</pre>		Press the  Key. The display is switched to the execution display of Fn004. Note: If the display is not switched and “NO-OP” is displayed in the status display, change the following settings. (Refer to 6.12.) <ul style="list-style-type: none"> • If Write Prohibited is set in Fn010: → Cancel the Write Prohibited setting. • If a servo ON command is input: → Send a servo OFF command.
3	<pre>BB -PRG JOG- Pn531=00032768 Pn533=00500 Pn534=00100 Pn536=00001</pre>		Press the  Key to select a parameter to be set. In this example, Pn536 has been selected.
4	<pre>BB -PRG JOG- Pn531=00032768 Pn533=00500 Pn534=00100 Pn536=00001</pre>		Press the  Key to move the cursor to the setting side (the right side) of Pn536.
5	<pre>BB -PRG JOG- Pn531=00032768 Pn533=00500 Pn534=00100 Pn536=00010</pre>	 	Press the  or  Key to change “1” to “10.”
6	<pre>RUN -PRG JOG- Pn531=00032768 Pn533=00500 Pn534=00100 Pn536=00010</pre>		Press the  Key to turn the servomotor power ON. The status of the display changes to “RUN”.
		 	Press the  (forward movement start) or  (reverse movement start) Key according to the first movement direction of the preset operation pattern for one second, the servomotor starts moving after the preset waiting time in Pn535. Note: Pressing the  Key again changes the status to “BB” (Servomotor power OFF) and stops movement even during operation.
7	<pre>END -PRG JOG- Pn531=00032768 Pn533=00500 Pn534=00100 Pn536=00010</pre>		When the set program JOG operation movement is completed, “END” will be displayed for one second, and then “RUN” will be displayed. Press the  Key. The servomotor enters BB status and the display returns to the Utility Function Mode main menu.
8	After program JOG operation, turn OFF the power and then turn ON again.		

6.6 Initializing Parameter Settings (Fn005)

This function is used when returning to the factory settings after changing parameter settings.

 IMPORTANT	<ul style="list-style-type: none"> • Be sure to initialize the parameter settings while the servomotor power is OFF. • After initialization, turn OFF the power supply and then turn ON again to validate the settings. • The parameters of the option module will not be initialized. For information on how to initialize the parameters of the option module, refer to the manual of the connected option module.
---	---

Follow the steps below to initialize the parameter setting.









Step	Display Example	Keys	Description
1	<pre>BB -FUNCTION- Fn004: Program JOG Fn005: Prm Init Fn006: AlmHist Clr Fn008: Mturn Clr</pre>	  	Press the  Key to open the Utility Function Mode main menu and select Fn005.
2	<pre>BB Parameter Init Start : [DATA] Return : [SET]</pre>		Press the  Key. The display is switched to the execution display of Fn005. Note: If the display is not switched and “NO-OP” is displayed in the status display, change the following settings. (Refer to 6.12.) <ul style="list-style-type: none"> • If Write Prohibited is set in Fn010: → Cancel the Write Prohibited setting. • If a servo ON command is input: → Send a servo OFF command.
3	<pre>BB Parameter Init Start : [DATA] Return : [SET]</pre>		Press the  Key to initialize parameters. During initialization, “Parameter Init” is blinking in the display. After the initialization is completed, “Parameter Init” stops blinking and the status display changes as follows: “BB” to “DONE.” Note: Press the  Key not to initialize parameters. The display returns to the Utility Function Mode main menu.
4	Turn OFF the power and then turn it ON again to validate the new setting.		

6.7 Clearing Alarm History (Fn006)

The clear alarm history function deletes all of the alarm history recorded in the SERVOPACK.

Note: The alarm history can be deleted only with this function. The alarm history is not deleted when the alarm reset is executed or the main circuit power supply of the SERVOPACK is turned OFF.

Follow the steps below to clear the alarm history.

Step	Display Example	Keys	Description
1	<pre>BB -FUNCTION- Fn005:Prm Init Fn006:AlmHist Clr Fn008:Mturn Clr Fn009:Ref Adj</pre>	  	Press the  Key to open the Utility Function Mode main menu and select Fn006.
2	<pre>BB Alarm History Data Clear Start : [DATA] Return: [SET]</pre>		Press the  Key. The display is switched to the execution display of Fn006. Note: If the display is not switched and “NO-OP” is displayed in the status display, the Write Prohibited Setting (Fn010 = 0001) is set. Check the setting and reset. (Refer to 6.12.)
3	<pre>DONE Alarm History Data Clear Start : [DATA] Return: [SET]</pre>		Press the  Key to clear the alarm history. While clearing the data, “DONE” is displayed in the status display. After the data has been successfully cleared, “BB” is displayed. Note: Press the  Key not to clear the alarm history. The display returns to the Utility Function Mode main menu.

6.8 Offset Adjustment of Analog Monitor Output (Fn00C)

This function is used to manually adjust the offsets for the analog monitor outputs (torque reference monitor output and motor speed monitor output). The offsets for the torque reference monitor output and motor speed monitor output can be adjusted individually. The offset values are factory-set before shipping. Therefore, the user need not usually use this function.

(1) Adjustment Example

An example of offset adjustment to the motor speed monitor is shown below.

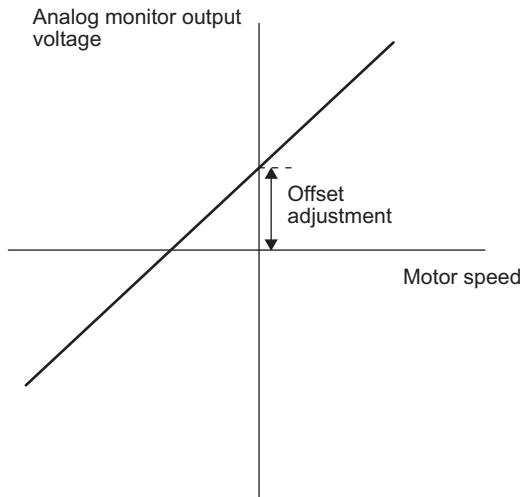







Item	Specifications
Zero-adjustment Range	-2.4 V to +2.4 V
Adjustment Unit	18.9 mV/LSB

<Notes>















- Offset adjustment cannot be made if write protection is set in Fn010.
- The adjustment value will not be initialized when parameter settings are initialized using Fn005.
- Make offset adjustment with a measuring instrument connected, so that the analog monitor output is zero. An example of settings for a zero analog monitor output is shown below.
 - While the motor is not turned ON, set the monitor signal to the torque reference.
 - In speed control, set the monitor signal to the position error.

(2) Operating Procedure

Follow the steps below to perform the offset adjustment of analog monitor output.

Step	Display Example	Keys	Description
1	<pre> BB -FUNCTION- Fn00B: Trq Adj Fn00C: MonZero Adj Fn00D: MonGain Adj Fn00E: Cur AutoAdj </pre>	  	Press the  Key to open the Utility Function Mode main menu and select Fn00C.
2	<pre> BB -Zero ADJ- CH1=-0000<u>2</u> CH2= 00001 Un002= 00000 Un000= 00000 </pre>		Press the  Key. The display is switched to the execution display of Fn00C. Note: If the display is not switched and “NO-OP” is displayed in the status display, the Write Prohibited Setting (Fn010 = 0001) is set. Check the setting and reset. (Refer to 6.12.)

(cont'd)

Step	Display Example	Keys	Description
3	<pre> BB -Zero ADJ- CH1=-0000<u>5</u> CH2= 0000<u>1</u> Un002= 00000 Un000= 00000 </pre>	 	<p>Press the  or  Key to adjust the offset of CH1 (torque reference monitor). Adjust the offset so that the measurement instrument reading is as close to 0 V as possible.</p>
4	<pre> BB -Zero ADJ- CH1=-00005 CH2= 0000<u>1</u> Un002= 00000 </pre>		<p>After the offset adjustment of CH1 has completed, Press the  Key. The cursor moves to CH2 side.</p>
5	<pre> BB -Zero ADJ- CH1=-00005 CH2= 0000<u>6</u> Un002= 00000 Un000= 00000 </pre>	 	<p>Press the  or  Key to adjust the offset of CH2. Adjust the offset so that the measurement instrument reading is as close to 0 V as possible.</p>
6	<pre> DONE -Zero ADJ- CH1=-00005 CH2= 0000<u>6</u> Un002= 00000 Un000= 00000 </pre>		<p>After having completed the offset adjustment both for CH1 and CH2, press the  Key. The adjustment results are saved in the SERVO-PACK. "DONE" is displayed in the status display after saving is completed.</p>
7	<pre> BB -FUNCTION- Fn00B: Trq Adj Fn00C: MonZero Adj Fn00D: MonGain Adj Fn00E: Cur AutoAdj </pre>		<p>Press the  Key to return to the Utility Function Mode main menu.</p>

6.9 Gain Adjustment of Analog Monitor Output (Fn00D)

This function is used to manually adjust the gains for the analog monitor outputs (torque reference monitor output and motor speed monitor output). The gains for the torque reference monitor output and motor speed monitor output can be adjusted individually. The gain values are factory-set before shipping. Therefore, the user need not usually use this function.

(1) Adjustment Example

An example of gains adjustment to the motor speed monitor is shown below.

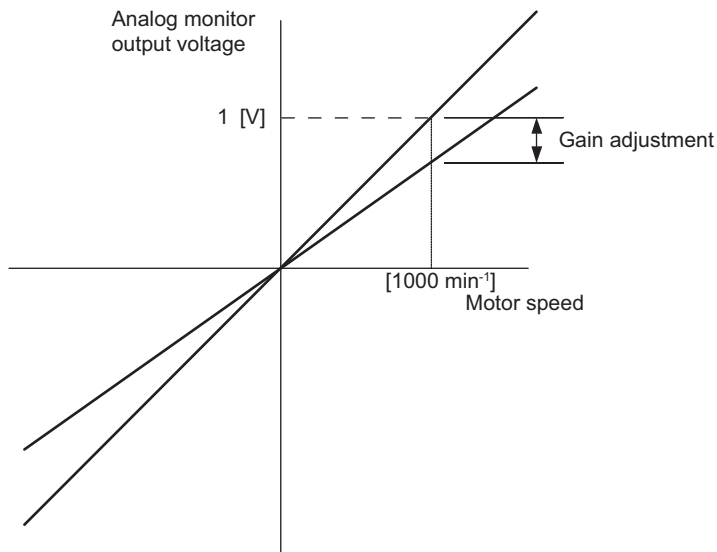

Item	Specifications
Gain-adjustment Range	50% to 150%
Adjustment Unit	0.4%/LSB

The gain adjustment width is made with a 100% output set as a center value (adjustment range: 50% to 150%). A setting example is shown below.

<Setting the Set Value to -125>

$$100\% + (-125 \times 0.4) = 50\%$$

Therefore, the monitor output voltage is 0.5 times as high.

<Setting the Set Value to 125>

$$100\% + (125 \times 0.4) = 150\%$$





















Therefore, the monitor output voltage is 1.5 times as high.

<Notes>

- Gain adjustment cannot be made if write protection is set in Fn010.
- The adjustment value will not be initialized when parameter settings are initialized using Fn005.

(2) Operating Procedure

Follow the steps below to perform the gain adjustment of analog monitor output.

Step	Display Example	Keys	Description
1	<pre> BB -FUNCTION- Fn00C: MonZero Adj Fn00D: MonGain Adj Fn00E: Cur AutoAdj Fn00F: Cur ManuAdj </pre>	  	Press the  Key to open the Utility Function Mode main menu and select Fn00D.
2	<pre> BB -Gain ADJ- CH1=-0000<u>1</u> CH2=-00001 Un002= 00000 Un000= 00000 </pre>		Press the  Key. The display is switched to the execution display of Fn00D. <ul style="list-style-type: none"> If the display is not switched and “NO-OP” is displayed in the status display, the Write Prohibited Setting (Fn010 = 0001) is set. Check the setting and reset. (Refer to 6.12.)
3	<pre> BB -Gain ADJ- CH1= 0012<u>5</u> CH2=-00001 Un002= 00000 Un000= 00000 </pre>	 	Press the  or  Key to adjust the gain adjustment width of CH1 (torque reference monitor).
4	<pre> BB -Gain ADJ- CH1= 00125 CH2=-0000<u>1</u> Un002= 00000 Un000= 00000 </pre>		After the gain adjustment of CH1, press the  Key. The cursor moves to CH2 side.
5	<pre> BB -Gain ADJ- CH1= 00125 CH2=-0012<u>5</u> Un002= 00000 Un000= 00000 </pre>	 	Press the  or  Key to adjust the gain adjustment width of CH2 (motor speed monitor).
6	<pre> DONE -Gain ADJ- CH1= 00125 CH2=-0012<u>5</u> Un002= 00000 Un000= 00000 </pre>		After having completed the adjustment both for CH1 and CH2, press the  Key. The adjustment results are saved in the SERVO-PACK. After the saving is completed, “DONE” is displayed in the status display.
7	<pre> BB -FUNCTION- Fn00C: MonZero Adj Fn00D: MonGain Adj Fn00E: Cur AutoAdj Fn00F: Cur ManuAdj </pre>		Press the  Key to return to the Utility Function Mode main menu.

6.10 Automatic Offset-Signal Adjustment of the Motor Current Detection (Fn00E)











Perform this adjustment only if highly accurate adjustment is required for reducing torque ripple caused by current offset. Basically, the user need not perform this adjustment.



IMPORTANT

- Be sure to perform this function while the servomotor power is OFF.
- Execute the automatic offset adjustment if the torque ripple is too big when compared with that of other SERVOPACKS.

Follow the steps below.





















Step	Display Example	Keys	Description
1	<pre>BB -FUNCTION- Fn00D: MonGain Adj Fn00E: Cur AutoAdj Fn00F: Cur ManuAdj Fn010: Prm Protect</pre>	  	Press the  Key to open the Utility Function Mode main menu and select Fn00E.
2	<pre>BB Auto Offset-ADJ of Motor Current Start : [DATA] Return : [SET]</pre>		Press the  Key. The display is switched to the execution display of Fn00E. Note: If the display is not switched and “NO-OP” is displayed in the status display, change the following settings. (Refer to 6.12.) <ul style="list-style-type: none"> • If Write Prohibited is set in Fn010: → Cancel the Write Prohibited setting. • If a servo ON command is input: → Send a servo OFF command.
3	<pre>DONE Auto Offset-ADJ of Motor Current Start : [DATA] Return : [SET]</pre>	 	Press the  Key to start the automatic offset-signal adjustment of motor current detection. When the adjustment is completed, “DONE” is displayed in the status display. Note: Press the  Key to cancel the automatic adjustment. The display returns to the Utility Function Mode main menu.

6.11 Manual Offset-Signal Adjustment of the Motor Current Detection (Fn00F)

Use this function only if the torque ripple is still high after the automatic offset adjustment of the motor current detection signal (Fn00E).

 IMPORTANT	<p>If this function is executed carelessly, it may worsen the characteristics. Observe the following precautions when performing manual servo tuning.</p> <ul style="list-style-type: none"> • Run the servomotor at a speed of approximately 100 min⁻¹. • Adjust the offset until the torque reference monitor ripple is minimized, monitoring the torque reference by using the analog monitor. • Adjust the phase-U and phase-V offsets alternately several times until these offsets are well balanced.
---	---

Follow the steps below.

Step	Display Example	Keys	Description
1	<pre> RUN -FUNCTION- Fn00F: Cur ManuAdj Fn010: Prm Protect Fn011: Motor Info Fn012: Soft Ver </pre>	  	Press the  Key to open the Utility Function Mode main menu and select Fn00F.
2	<pre> RUN Manual Offset-ADJ of Motor Current ZADJIU= 0000<u>9</u> ZADJIV= 00006 </pre>		Press the  Key. The display is switched to the execution display of Fn00F. Note: If the display is not switched and “NO-OP” is displayed in the status display, the Write Prohibited Setting (Fn010 = 0001) is set. Check the setting and reset. (Refer to 6.12.)
3	<pre> RUN Manual Offset-ADJ of Motor Current ZADJIU= 0001<u>9</u> ZADJIV= 00006 </pre>	 	Press the  or  Key to adjust the offset amount of phase-U. Adjust the offset amount by 10 in the direction that the torque ripple is reduced. Adjustment range: -512 to +511
4	<pre> RUN Manual Offset-ADJ of Motor Current ZADJIU= 00019 ZADJIV= 0000<u>6</u> </pre>		Press the  Key. The cursor moves to the phase-V side.
5	<pre> RUN Manual Offset-ADJ of Motor Current ZADJIU= 00019 ZADJIV= 0001<u>6</u> </pre>	 	Press the  or  Key to adjust the offset amount of phase-V. Adjust the offset amount by 10 in the direction that the torque ripple is reduced. Adjustment range: -512 to +511
6	Repeat the above operations (phase-U and -V alternately) until adjusting the offset amounts both for phase-U and -V in both directions cannot reduce the torque ripple any more. Then, perform the same operation by adjusting by smaller amount.		
7	<pre> DONE Manual Offset-ADJ of Motor Current ZADJIU= 00019 ZADJIV= 0001<u>6</u> </pre>		Press the  Key to save the result of adjustment in the SERVOPACK. When the saving is completed, “DONE” is displayed in the status display.
8	<pre> RUN -FUNCTION- Fn00F: Cur ManuAdj Fn010: Prm Protect Fn011: Motor Info Fn012: Soft Ver </pre>		Press the  Key to return to the Utility Function Mode main menu.

6.12 Write Prohibited Setting (Fn010)

Prohibiting writing prevents writing parameters by mistake.

The following operations can be write-protected using the Fn010 parameter.

- Parameter settings from the digital operator (Pn□□□)
- Utility functions shown in (1) *Utility Functions That Can Be Write-protected* (Fn□□□)

(1) Utility Functions That Can Be Write-protected

Function No.	Function	Write Prohibited Setting	Reference Section
Fn000	Alarm history display	×	6.2
Fn002	JOG operation	○	6.3
Fn003	Origin search	○	6.4
Fn004	Program JOG operation	○	6.5
Fn005	Initializing parameter settings	○	6.6
Fn006	Clearing alarm history	○	6.7
Fn008	Absolute encoder multi-turn reset and encoder alarm reset	○	4.5.4
Fn00C	Manual zero adjustment of analog monitor output	○	6.8
Fn00D	Manual gain adjustment of analog monitor output	○	6.9
Fn00E	Automatic offset-signal adjustment of motor current detection signal	○	6.10
Fn00F	Manual offset-signal adjustment of motor current detection signal	○	6.11
Fn010	Write prohibited setting	–	6.12
Fn011	Servomotor model display	×	6.13
Fn012	Software version display	×	6.14
Fn013	Multi-turn limit value setting change when a Multi-turn Limit Disagreement alarm occurs	○	4.5.7
Fn014	Resetting configuration error of option module	○	6.15
Fn01B	Vibration detection level initialization	○	6.16
Fn01E	Display of SERVOPACK and servomotor ID	×	6.17
Fn01F	Display of servomotor ID in feedback option module	×	6.18
Fn020	Origin setting	×	6.19
Fn030	Software reset	×	6.20
Fn200	Tuning-less level setting	○	5.2.2
Fn201	Advanced autotuning	○	5.3.2
Fn202	Advanced autotuning by reference	○	5.4.2
Fn203	One-parameter tuning	○	5.5.2
Fn204	Anti-resonance control adjustment function	○	5.6.2
Fn205	Vibration suppression function	○	5.7.2
Fn206	EasyFFT	○	6.21
Fn207	Online vibration monitor	○	6.22

Note 1. ○: Possible, ×: Impossible













2. If the write prohibited setting (Fn010) is enabled, “NO-OP” is displayed on the status display of the Digital Operator if the user attempts to execute the above utility functions. To execute these utility functions, set Fn010 to write permitted by using the procedure shown in (2) *Operating Procedure*.

(2) Operating Procedure

Follow the steps below to set “write prohibited” or “write permitted.”

Setting values are as follows:









- “P.0000”: Write permitted (Releases write prohibited mode.) [Factory setting]
- “P.0001”: Write prohibited (Parameters become write prohibited from the next power ON.)

Step	Display Example	Keys	Description
1	<pre> BB -FUNCTION- Fn00F:Cur ManuAdj Fn010:Prm Protect Fn011:Motor Info Fn012:Soft Ver </pre>	  	Press the  Key to open the Utility Function Mode main menu and select Fn010.
2	<pre> BB Parameter Write Protect P. 000<u>0</u> </pre>		Press the  Key. The display switches to the execution display of Fn010.
3	<pre> BB Parameter Write Protect P. 000<u>1</u> </pre>	 	Press the  Key to select one of the following settings. P.0000: Write permitted [Factory setting] P.0001: Write prohibited
4	<pre> DONE Parameter Write Protect P. 000<u>1</u> </pre>		Press the  Key to save the setting value in the SERVOPACK. When the saving is completed, “DONE” is displayed in the status display.
5	<pre> BB -FUNCTION- Fn00F:Cur ManuAdj Fn010:Prm Protect Fn011:Motor Info Fn012:Soft Ver </pre>		Press the  Key to return to the Utility Function Mode main menu.
6	Turn OFF the power and then turn it ON again to validate the new setting.		

6.13 Servomotor Model Display (Fn011)

This function is used to check the servomotor model, voltage, capacity, encoder type, and encoder resolution. If the SERVOPACK has been custom-made, you can also check the specification codes of SERVOPACKs.

Follow the steps below.

Step	Display Example	Keys	Description
1	<pre> RUN -FUNCTION- Fn010:Prm Protect Fn011:Motor Info Fn012:Soft Ver Fn013:MturnLmSet </pre>	  	Press the  Key to open the Utility Function Mode main menu and select Fn011.
2	<pre> BB -MotorInfo- TYPE 60 AC200V 400W ENCORDER 01 20bit </pre> <p>(Example)</p>		Press the  Key to switch to the display of Fn011.
3	<pre> RUN -FUNCTION- Fn010:Prm Protect Fn011:Motor Info Fn012:Soft Ver Fn013:MturnLmSet </pre>		Press the  Key to return to the Utility Function Mode main menu.



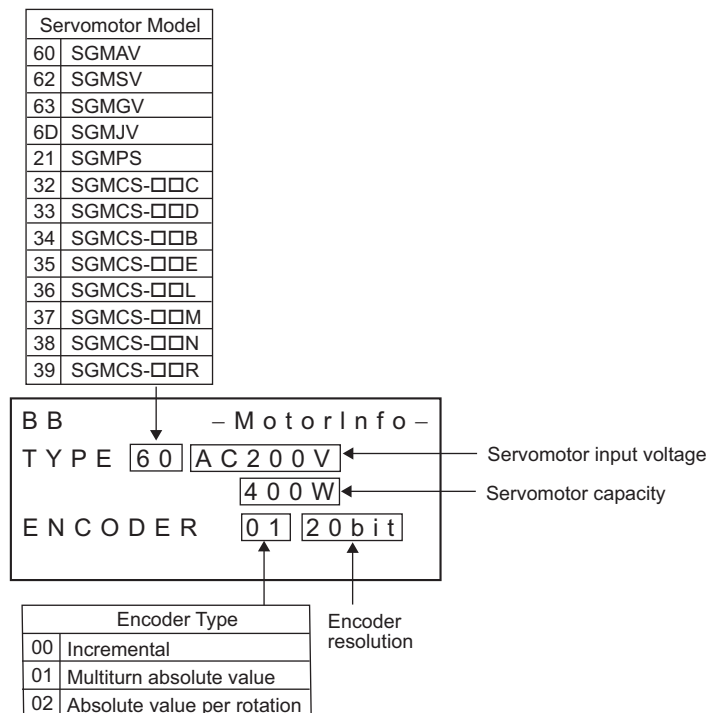













■ Display Designation



6.14 Software Version Display (Fn012)

Select Fn012 to check the SERVOPACK and encoder software version numbers.

Follow the steps below.

Step	Display Example	Keys	Description
1	<pre>BB -FUNCTION- Fn011:Motor Info Fn012:Soft Ver Fn013:MturnLmSet Fn014:Opt Init</pre>	  	Press the  Key to open the Utility Function Mode main menu and select Fn012.
2	<pre>BB -Soft Ver- DRIVER Ver.=0001 ENCODER Ver.=0003</pre>		Press the  Key. The software versions of the SERVOPACK and the connected encoder will be displayed. Note: If the servomotor is not connected, “Not connect” is displayed under “ENCODER” instead of the version number.
3	<pre>BB -Soft Ver- OPTION ENCODER Ver.=0001</pre>		Press the  Key. The software version of the external encoder will be displayed. Note: If an external encoder is not connected, “Not connect” will be displayed.
4	<pre>BB -Soft Ver- COMMAND Ver.=0001</pre>		Press the  Key. The software version of the command option module will be displayed. Note: If a command option module is not connected, “Not connect” will be displayed.
5	<pre>BB -Soft Ver- SAFETY Ver.=0001</pre>		Press the  Key. The software version of the safety option module will be displayed. Note: If a safety option module is not connected, “Not connect” will be displayed.
6	<pre>BB -Soft Ver- FEEDBACK Ver.=0001</pre>		Press the  Key. The software version of the feedback option module will be displayed. Note: If a feedback option module is not connected, “Not connect” will be displayed.
7	<pre>BB -FUNCTION- Fn011:Motor Info Fn012:Soft Ver Fn013:MturnLmSet Fn014:Opt Init</pre>		Press the  Key to return to the Utility Function Mode main menu.

6.15 Resetting Configuration Error of Option Module (Fn014)

The SERVOPACK with option module recognizes installation status and types of option module which is connected to SERVOPACK. If an error is detected, the SERVOPACK issues an alarm.

This function resets the following alarms.

- Command Option Module Unmatched Error (A.E80)
- Feedback Option Module Detection Failure (A.E72)















For alarm types and corrective actions, refer to *9 Troubleshooting*.

Note 1. The alarms above can be cleared only by this function. These alarms cannot be cleared by alarm reset or turning OFF the main circuit power supply.

2. Before clearing the alarm, perform corrective action for the alarm.

(1) Operating Procedure

Follow the steps below.

Step	Display Example	Keys	Description
1	<pre>BB -FUNCTION- Fn013:MturnLmSet Fn014:Opt Init Fn01B:Vibl_vl Init Fn01E:SvMotOp ID</pre>	  	Press the  Key to open the Utility Function Mode main menu and select Fn014.
2	<pre>BB -Opt Init- 01:Command Opt 02:Safety Opt 03:Feedback Opt</pre>		Press the  Key. The display changes to the execution display of Fn014.
3	<pre>BB -Opt Init- Command Opt Initialize Start :[DATA] Return:[SET]</pre>	  	Press the  or  Key to select an option module to be cleared. Note: If the display is not switched and “NO-OP” is displayed in the status display, the Write Prohibited Setting (Fn010 = 0001) is set. Check the setting and reset. (Refer to 6.12.)
4	<pre>DONE -Opt Init- Command Opt Initialize Start :[DATA] Return:[SET]</pre>		Press the  Key to clear the configuration error of the option module.
5	<pre>RUN -FUNCTION- Fn013:MturnLmSet Fn014:Opt Init Fn01B:Vibl_vl Init Fn01E:SvMotOp ID</pre>		Press the  key to return to the Utility Function Mode main menu.
6	Turn OFF the power and then turn it ON again to validate the new setting.		

6.16 Vibration Detection Level Initialization (Fn01B)

This function detects vibration when servomotor is connected to a machine and automatically adjusts the vibration detection level (Pn312) to output more exactly the vibration alarm (A.520) and warning (A.911).

Use this function if the vibration alarm (A.520) or warning (A.911) is not output correctly when a vibration above the factory setting vibration detection level (Pn312) is detected. In other cases, it is not necessary to use this function.

The vibration detection function detects vibration elements according to the motor speed.

Parameter	Meaning	When Enabled	Classification	
Pn310	n.□□□0	Does not detect vibration. (Factory setting)	Immediately	Setup
	n.□□□1	Outputs the warning (A.911) when vibration is detected.		
	n.□□□2	Outputs the alarm (A.520) when vibration is detected.		

If the vibration exceeds the detection level calculated by the following formula, the alarm or warning will be output according to the setting of vibration detection switch (Pn310).

$$\text{Detection level} = \frac{\text{Vibration detection level (Pn312}[\text{min}^{-1}]) \times \text{Detection sensibility (Pn311}[\%])}{100}$$







<Remarks>

The vibration alarm or warning detection sensibility differs depending on the machine conditions. In this case, a detection sensibility fine adjustment can be set in the detection sensibility Pn311.







 IMPORTANT	<ul style="list-style-type: none"> • The vibration may not be detected because of improper servo gains. Also, not all kinds of vibrations can be detected. Use the detection result as a guideline. • Set a proper moment of inertia ratio (Pn103). Improper setting may result in the vibration alarm, warning misdetection, or non-detection. • The references that are used to operate your system must be input to execute this function. • Execute this function under the operation condition for which the vibration detection level should be set. • Execute this function to set the vibration detection level while the motor speed reaches at least 10% of its maximum.
---	---

(1) Operating Procedure

Follow the steps to adjust the parameter Pn312.







Step	Display Example	Keys	Description
1	<pre> RUN - FUNCTION - Fn014: Opt Init Fn01B: Vibl_vl Init Fn01E: SvMotOp ID Fn01F: FB Op Mot ID </pre>	  	Press the  Key to open the Utility Function Mode main menu and select Fn01B.
2	<pre> RUN Vibration Detect Level Init Start : [DATA] Return: [SET] </pre>		Press the  Key. The display is switched to the execution display of Fn01B. Note: If the display is not switched and “NO-OP” is displayed in the status display, the Write Prohibited Setting (Fn010 = 0001) is set. Check the setting and reset. (Refer to 6.12.)

(cont'd)

Step	Display Example	Keys	Description
3	<pre> RUN Vibration Detect Level Init Init </pre>		Press the  Key. “Init” is displayed blinking, and the vibration level is detected and adjusted. Continues adjustment until the  Key is pressed again. Notes: • Operate the SERVOPACK with the references that will be used for actual operation. • If the servomotor is rotating at 10% or less of the maximum speed, “Error” will be displayed.
4	<pre> DONE Vibration Detect Level Init DONE </pre>		Press the  Key. The display changes from “Init” to “DONE,” and the setting becomes enabled.
5	<pre> RUN -FUNCTION- Fn014: Opt Init Fn01B: Vibl_vl Init Fn01E: SvMotOp ID Fn01F: FBOPMot ID </pre>		Press the  key to return to the Utility Function Mode main menu.

(2) Related Parameters

Use the following parameters as required.

Pn311	Vibration Detection Sensibility   				Classification
	Setting Range	Setting Unit	Factory Setting	When Enabled	
	50 to 500	1%	100	Immediately	Tuning
Pn312	Vibration Detection Level   				Classification
	Setting Range	Setting Unit	Factory Setting	When Enabled	
	0 to 5000	1 min ⁻¹	50	Immediately	Tuning

Note: Vibration Detection Level (Pn312) is set by Fn01B automatically, so it is not necessary to adjust it.

6.17 Display of SERVOPACK and Servomotor ID (Fn01E)

This function displays ID information for SERVOPACK, servomotor, encoder and option module connected to the SERVOPACK.

Note that the ID information of some option modules is not stored in the SERVOPACK. “Not available” will be displayed for these option modules.

The following items can be displayed.

ID	Items to be Displayed
SERVOPACK	<ul style="list-style-type: none"> • SERVOPACK model • SERVOPACK serial number • SERVOPACK manufacturing date • SERVOPACK input voltage (V) • Maximum applicable motor capacity (W) • Maximum applicable motor rated current (Arms)
Servomotor	<ul style="list-style-type: none"> • Servomotor model • Servomotor order number • Servomotor manufacturing date • Servomotor input voltage (V) • Servomotor capacity (W) • Servomotor rated current (Arms)
Encoder	<ul style="list-style-type: none"> • Encoder model • Encoder serial number • Encoder manufacturing date • Encoder type/resolution
Command Option Module*	<ul style="list-style-type: none"> • Command option module model • Command option module serial number • Command option module manufacturing date • Command option module ID number
Safety Option Module*	<ul style="list-style-type: none"> • Safety option module model • Safety option module serial number • Safety option module manufacturing date • Safety option module ID number
Feedback Option Module*	<ul style="list-style-type: none"> • Feedback option module model • Feedback option module serial number (Reserved area) • Feedback option module manufacturing date • Feedback option module ID

* If an option module is not connected, “Not connect” will be displayed after the module name.

6.18 Display of Servomotor ID in Feedback Option Module (Fn01F)

This function displays ID information for servomotor and encoder in feedback option module connected to the SERVOPACK.

The following items can be displayed.

ID	Items to be Displayed
Servomotor	<ul style="list-style-type: none"> • Servomotor model • Servomotor order number • Servomotor input voltage (V) • Servomotor capacity (W) • Servomotor rated current (Arms)
Encoder	<ul style="list-style-type: none"> • Encoder model • Encoder serial number • Encoder type/resolution (Two types of resolution display available: Number of bits and pulses/rev.)
Parameter file	<ul style="list-style-type: none"> • Parameter file source ID (14 characters) • Parameter file version (4 digits hexadecimal display)

6.19 Origin Setting (Fn020)

When using an external encoder for fully-closed loop control, this function is used to set the current position of external encoder as the origin (zero point position).

This function sets current scale position as origin when using the absolute external encoder.

Use the following product as an absolute external encoder.















Absolute separate linear scale (made by Mitutoyo Corporation)
 ABS ST780A series
 Model ABS ST78□A

(1) Settings before Operation

The following settings are required before setting origin.

- If a servo ON command is input, send a servo OFF command.

(2) Operating Procedure

Step	Display Example	Keys	Description
1	<pre> BB - FUNCTION - Fn01F:FBOPMot ID Fn020:S-Orig Set Fn030:Soft Reset Fn080:Pole Detect </pre>	  	Press the  Key to open the Utility Function Mode main menu and select Fn020.
2	<pre> BB Scale Origin Set ORGSET1 </pre>		Press the  Key. The display is switched to the execution display of Fn020. Note: If the display is not switched and “NO-OP” is displayed in the status display, change the following settings. <ul style="list-style-type: none"> • If Write Prohibited is set in Fn010: → Cancel the Write Prohibited setting. • If a servo ON command is input: → Send a servo OFF command.
3	<pre> BB Scale Origin Set ORGSET5 </pre>	 	Press the  or  Key to select one of five origins: ORGSET1 to ORGSET5.
4	<pre> BB Scale Origin Set </pre>		Press the  key to start setting the origin. The message, “Scale Origin Set,” blinks while the origin is being set. After the origin has been successfully set, the displayed status changes as follows: “BB”→“DONE”→“BB”
5	<pre> BB - FUNCTION - Fn01F:FBOPMot ID Fn020:S-Orig Set Fn030:Soft Reset Fn080:Pole Detect </pre>		Press the  Key to return to the Utility Function Mode main menu.
6	Turn OFF the power and then turn it ON again to validate the new setting.		

6.20 Software Reset (Fn030)

This function enables resetting the SERVOPACK internally from software. The operation of turning OFF the power and then turning ON again to validate the setting can be omitted by executing this function.

 IMPORTANT	<ul style="list-style-type: none"> • Starts software reset operation when the servomotor power is OFF. • This function resets the SERVOPACK independently of host controller. The SERVOPACK carries out the same processing as when the power supply is turned ON and outputs the ALM signal. The status of other output signals may be forcibly changed.
---	---















(1) Setting before Operation

The following settings are required before executing the software reset function.

- If a servo ON command is input, send a servo OFF command.

(2) Operating Procedure

Follow the steps below to reset the SERVOPACK internally.

Step	Display Example	Keys	Description
1	<pre> BB -FUNCTION- Fn020:S-Orig Set Fn030:Soft Reset Fn080:Pole Detect Fn200:TuneLvl Set </pre>	  	Press the  Key to open the Utility Function Mode main menu and select Fn030.
2	<pre> BB Software Reset RESET1 </pre>		Press the  Key. The display is switched to the execution display of Fn030.
3	<pre> BB Software Reset RESET5 </pre>	 	Press the  or  Key to select RESET5.
4	<pre> BB Software Reset </pre>		Press the  Key to execute the software reset. "RESET5" is no longer displayed.
5	<pre> File First Loading Please Wait... </pre>		After the reset has been successfully completed, the screen which appears when the power is turned ON will be displayed. Then, the mode changes to the parameter/monitor display mode.
6	<pre> BB -FUNCTION- Fn020:S-Orig Set Fn030:Soft Reset Fn080:Pole Detect Fn200:TuneLvl Set </pre>		Press the  Key to return to the Utility Function Mode main menu.

6.21 EasyFFT (Fn206)

EasyFFT sends a frequency waveform reference from the SERVOPACK to the servomotor and rotates the servomotor at minimal speed a number of times over a certain period, thus causing machine vibration. The SERVOPACK detects the resonance frequency from the generated vibration and makes notch filter settings according to the resonance frequency detection. The notch filter is effective for the elimination of high-frequency vibration and noise.

⚠ WARNING

- The servomotor rotates at minimal speed when EasyFFT is executed. Do not touch the servomotor or machine during execution of EasyFFT, otherwise injury may result.

⚠ CAUTION

- Use the EasyFFT when the servo gain is low, such as in the initial stage of servo adjustment. If EasyFFT is executed after increasing the gain, the servo system may vibrate depending on the machine characteristics or gain balance.

Machine vibration may be suppressed by setting a notch filter according to the detected vibration frequency.

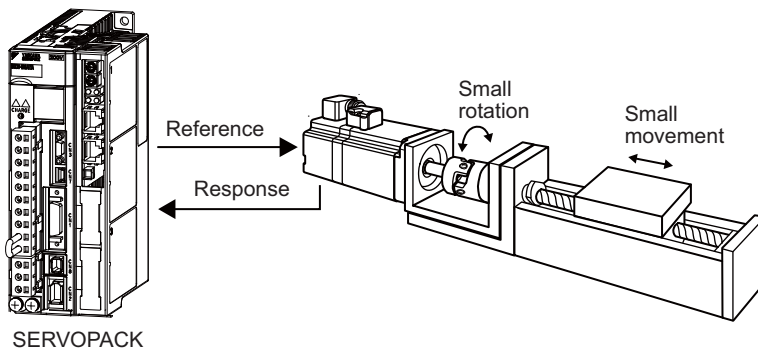

In addition to this function, Online Vibration Monitor (Fn207) can be used to detect machine vibration and automatically make notch filter settings. Use the following flowchart to determine which function should be used.

When using mainly for servo gain adjustment, etc.

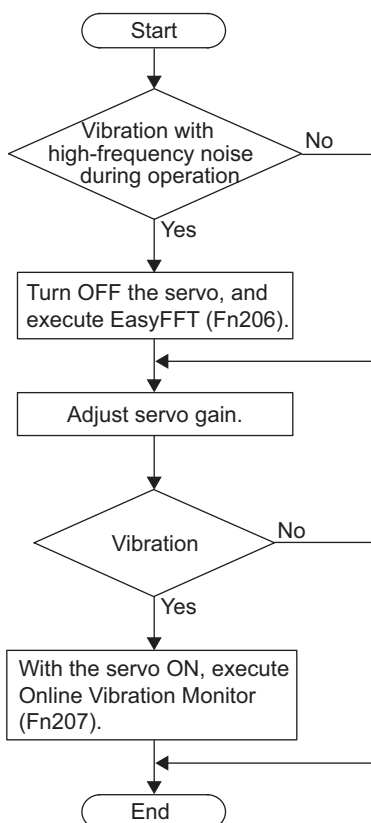







IMPORTANT

















- Starts EasyFFT when the servomotor power is OFF.
- Do not input the reference from outside because EasyFFT outputs the special reference from the SERVOPACK.

(1) Operating Procedure





Follow the steps below.

Step	Display Example	Keys	Description
1	<pre> BB -FUNCTION- Fn205:Vib Sup Fn206:Easy FFT Fn207:V-Monitor Fn000:Alm History </pre>	  	Press the  Key to open the Utility Function Mode main menu and select Fn206.
2	<pre> BB -Easy FFT- Setting Input = 015% </pre>		Press the  Key. The display is switched to the execution display of Fn206. Note: If the display is not switched and “NO-OP” is displayed in the status display, change the following settings. (Refer to 6.12.) <ul style="list-style-type: none"> •If Write Prohibit is set in Fn010: → Cancel the Write Prohibited setting. •If a servo ON command is input: → Send a servo OFF command.

(cont'd)

Step	Display Example	Keys	Description
3	<pre>BB -Easy FFT- Setting Input = 015%</pre>	 	<p>The cursor is on the setting of "Input." Press the  or  Key to set the sweep torque reference amplitude (Pn456) Setting range: 1 to 800.</p> <p>Note: When making the initial settings for EasyFFT, do not change the setting for the reference amplitude. Start with the original value of 15. Increasing reference amplitude increases the detection accuracy, but the vibration and noise from the machine will increase. Increase the amplitude value little by little.</p>
4	<pre>RUN -Easy FFT- Ready Input = 015%</pre>		<p>Press the  Key to turn the servomotor power ON. The display "BB" and "Setting" changes to "RUN" and "Ready."</p>
5	<pre>RUN -Easy FFT- Measure Input = 015%</pre>	 	<p>Press the  (forward run start) Key or  (reverse run start) Key to run the servomotor and start the frequency measurement. "Measure" is displayed blinking during the measurement.</p> <p>Within a quarter turn, the servomotor will move forward and then in reverse several times. The total operation time is between 1 and 45 seconds.</p> <p>Note: The actions of the servomotor are very minute in this operation. Also at the same time, the servomotor emits a noise. To ensure safety, do not enter the working envelope of the motor.</p>
6	<pre>RUN -Easy FFT- Result Input = 015 % Res = 1250 Hz Filter 1 1375 Hz</pre>		<p>When the detection has completed normally, the result and the notch filter value to be set are displayed.</p> <p>Press the  Key to turn OFF the power to the servomotor.</p> <p>< Important ></p> <p>If 2 seconds or more are required for the operation although detection was successfully completed, the detection accuracy might be insufficient. Increasing reference amplitude more than 15 increases the detection accuracy, but the vibration and noise from the machine will increase. Increase the amplitude value little by little.</p> <p>Notes:</p> <ul style="list-style-type: none"> • If a notch filter has been set and is being used, "*" is displayed on the second line. • If the first notch filter has been set, the second notch filter value is displayed. If the first and second notch filters have been set, only the result of frequency detection is displayed. • If the  Key is pressed while the servomotor is running, the servomotor will stop, and the frequency detection will be canceled. • If the detection is not completed normally, "No Measure" is displayed.
7	<pre>RUN -Easy FFT- Ready Input = 015%</pre>	 	<p>Press the  Key to exit the EasyFFT function at this stage. The power to the servomotor is turned OFF and the display returns to the Utility Function Mode main menu.</p> <p>Press the  Key to return to "Ready" display.</p>

(cont'd)

Step	Display Example	Keys	Description
8	<pre> Done -Easy FFT- Result Input = 015 % Res = 1250 Hz Filter1 1375 Hz </pre>		<p>Press the  Key after the normal completion of frequency detection. The notch filter frequencies are updated to the optimum values. If the first notch filter frequency has been set, set the second notch filter frequency (Pn 40C) to Pn 408.0 = 1.</p> <p>Notes:</p> <ul style="list-style-type: none"> • If the second stage notch filter frequency has already been set (Pn408.2 = 1), the notch filter frequency cannot be set. • If the frequency detected by this function is not used, set the notch filter to be invalid (Pn408.0 = 0).
9	<pre> BB -FUNCTION- Fn205: Vib Sup Fn206: Easy FFT Fn207: V-Monitor Fn000: Alm History </pre>		<p>Press the  Key to return to the Utility Function Mode main menu.</p>
10	Turn OFF the power and then turn ON again to validate the setting.		

(2) Related Parameters

The Easy FFT related parameters are listed below. These parameters will be automatically set and the user need not set them manually.

Parameter	Meaning	When Enabled	Classification	
Pn408	n.□□□0	Disables 1st notch filter. (Factory setting)	Immediately	Setup
	n.□□□1	Uses 1st notch filter.		
	n.□0□□	Disables 2nd notch filter. (Factory setting)		
	n.□1□□	Uses 2nd notch filter.		

Pn409	1st Notch Filter Frequency				Classification
	Setting Range	Setting Unit	Factory Setting	When Enabled	
	50 to 5000	1 Hz	5000	Immediately	

Pn40C	2nd Notch Filter Frequency				Classification
	Setting Range	Setting Unit	Factory Setting	When Enabled	
	50 to 5000	1 Hz	5000	Immediately	

Pn456	Sweep Torque Reference Amplitude				Classification
	Setting Range	Setting Unit	Factory Setting	When Enabled	
	1 to 800	1%	15	Immediately	

6.22 Online Vibration Monitor (Fn207)

The machine vibration can sometimes be suppressed by setting a notch filter or torque reference filter for the vibration frequencies.

When online, vibration frequencies caused by machine resonance will be detected and the frequency that has the highest peak will be displayed on the Panel Operator. The effective torque reference filter or notch filter frequency for the vibration frequency will be automatically selected and the related parameters will be automatically set.





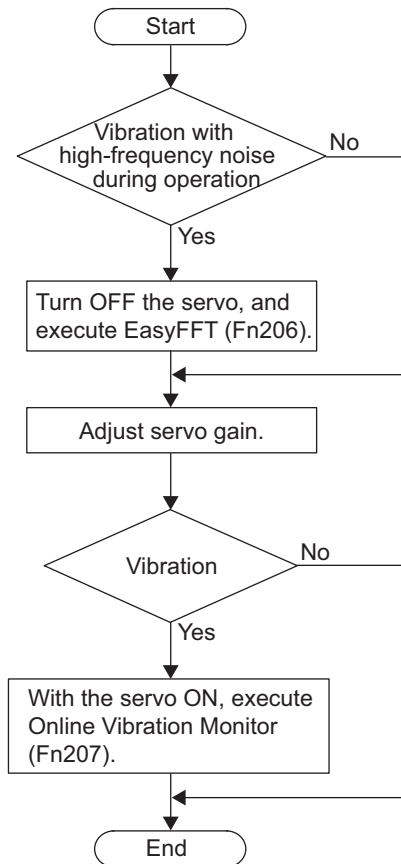







In addition to this function, EasyFFT (Fn206) can be used to detect machine vibration and automatically make notch filter settings. Use the following flowchart to determine which function should be used.

When using mainly for servo gain adjustment, etc.



(1) Operating Procedure

Follow the steps below.

Step	Display Example	Keys	Description
1	<pre> RUN -FUNCTION- Fn206: Easy FFT Fn207: V-Monitor Fn000: Alm History Fn001: JOG </pre>	  	Press the  Key to open the Utility Function Mode main menu and select Fn207.
2	<pre> RUN -V-MONITOR- Measure F1=----- F2=----- F3=----- </pre>		Press the  Key. The display is switched to the execution display of Fn207. Note: If the display is not switched and “NO-OP” is displayed in the status display, the Write Prohibit is set in Fn010. Check the setting and reset. (Refer to 6.12.)
3	<pre> RUN -V-MONITOR- Measure F1=----- F2=----- F3=----- </pre>		Press the  Key for 1 second. The message, “Measure,” blinks, and vibration detection will start.
4	<pre> RUN -V-MONITOR- Measure F1= 0850 [Hz] F2= 1600 [Hz] F3= 0225 [Hz] </pre>		When the vibration detection has completed, “Measure” stops blinking and the detection ends automatically. When the detection has completed normally, the vibrations with three largest peak values in vibration frequency are displayed for F1, F2, and F3. Notes: <ul style="list-style-type: none"> • Press the  Key to quit the online vibration monitor function. The display returns to the Utility Function Mode main menu. • Three detected frequencies can be displayed. For a vibration with undetectable peak frequency, “----” is displayed. If no frequency was detected, “----” is displayed for F1, F2, and F3. • If the frequency could not be successfully detected, “NO MONITOR” is displayed.
5	<pre> DONE -V-MONITOR- SETTING DONE F1= 0850 [Hz] F2= 1600 [Hz] F3= 0225 [Hz] </pre>		After the detection has normally completed, press the  Key. The optimum frequency (time constant) of notch filter or torque reference filter for F1 is set automatically. At the same time, the parameter Pn409 is updated for a notch filter, or the parameter Pn401 is updated for a torque reference filter.
6	<pre> RUN -FUNCTION- Fn206: Easy FFT Fn207: V-Monitor Fn000: Alm History Fn001: JOG </pre>		Press the  Key to return to the Utility Function Mode main menu.

(2) Related Parameters

The following parameters are set automatically by using online vibration monitor.

Parameter	Meaning
Pn401	1st Step 1st Primary Torque Reference Filter Time Constant
Pn408	Torque Related Function Switch
Pn409	1st Notch Filter Frequency

Monitor Modes (Un□□□)

7.1 List of Monitor Modes	7-2
7.2 Monitor Displays	7-3

7.1 List of Monitor Modes

The monitor mode can be used for monitoring the reference values, I/O signal status, and SERVOPACK internal status on the digital operator.

Refer to the following table.

Parameter No.	Content of Display	Unit
Un000	Motor rotating speed	min ⁻¹
Un001	Speed reference (for speed control)	min ⁻¹
Un002	Internal torque reference (in percentage to the rated torque)	%
Un003	Electric angle 1	pulse (encoder resolution)
Un004	Electric angle 2	deg
Un005	Input signal monitor	–
Un006	Output signal monitor	–
Un007	Reference speed (for position control)	min ⁻¹
Un008	Position error (for position control)	reference unit
Un009	Accumulated load ratio (in percentage to the rated torque: effective torque in cycle of 10 seconds)	%
Un00A	Regenerative load ratio (in percentage to the processable regenerative power: regenerative power consumption in cycle of 10 seconds)	%
Un00B	Power consumed by DB resistance (in percentage to the processable power at DB activation: displayed in cycle of 10 seconds)	%
Un00C	Reference counter	reference unit
Un00D	Feedback pulse counter	pulse (encoder resolution)
Un00E	Fully-closed feedback pulse counter	pulse (encoder resolution)
Un012	Total operation time	100 ms
Un013	Feedback pulse counter	reference unit
Un014	Effective gain monitor (gain setting 1 = 1, gain setting 2 = 2)	–
Un015	Safety I/O signal monitor	–
Un020	Motor rated rotational speed	min ⁻¹
Un021	Motor maximum rotational speed	min ⁻¹

7.2 Monitor Displays

Monitor mode can be checked in the Parameter/Monitor Mode (-PRM/MON-) window of the digital operator.

The following four Un numbers are displayed as the factory settings.

BB	-PRM/MON-
Un00 <u>0</u>	= 00000
Un00 <u>2</u>	= 00000
Un00 <u>8</u>	= 00000
Un00 <u>D</u>	= 00000000

← Indicates that the value of Un000 (motor speed) is 0 min⁻¹.

To view other Un numbers, press the or Key to scroll through the list in monitor mode.

Motor speed	Un00 <u>0</u> = 00000	<input type="button" value="▼"/> <input type="button" value="▲"/> <input type="button" value="↓"/> <input type="button" value="↑"/>
Speed reference	Un00 <u>1</u> = 00000	<input type="button" value="▼"/> <input type="button" value="▲"/> <input type="button" value="↓"/> <input type="button" value="↑"/>
Internal torque reference	Un00 <u>2</u> = 00000	<input type="button" value="▼"/> <input type="button" value="▲"/> <input type="button" value="↓"/> <input type="button" value="↑"/>
Electric angle 1	Un00 <u>3</u> = 00000	<input type="button" value="▼"/> <input type="button" value="▲"/> <input type="button" value="↓"/> <input type="button" value="↑"/>
Electric angle 2 (angle from origin)	Un00 <u>4</u> = 00090	<input type="button" value="▼"/> <input type="button" value="▲"/> <input type="button" value="↓"/> <input type="button" value="↑"/>
		<input type="button" value="▼"/> <input type="button" value="▲"/> <input type="button" value="⋮"/> <input type="button" value="↑"/>
Feedback pulse counter	Un00 <u>D</u> = 00000000	<input type="button" value="▼"/> <input type="button" value="▲"/> <input type="button" value="↓"/> <input type="button" value="↑"/>

Fully-closed Loop Control

8.1 System Configuration and Connection Example for SERVOPACK with Fully-closed Loop Control	8-2
8.1.1 System Configuration	8-2
8.1.2 Internal Block Diagram of Fully-closed Loop Control	8-3
8.1.3 Serial Converter Unit	8-4
8.1.4 Example of Connections to External Encoders	8-6
8.1.5 Encoder Output Pulse Signals from SERVOPACK with an External Encoder by Renishaw plc	8-7
8.1.6 Precautions When Using an External Incremental Encoder by Magnescale	8-8
8.2 SERVOPACK Startup Procedure	8-12
8.3 Parameter Settings for Fully-closed Loop Control	8-14
8.3.1 Motor Rotation Direction	8-15
8.3.2 Sine Wave Pitch (Frequency) for an External Encoder	8-17
8.3.3 Setting Encoder Output Pulses (PAO, PBO, and PCO)	8-17
8.3.4 External Absolute Encoder Data Reception Sequence	8-18
8.3.5 Electronic Gear	8-21
8.3.6 Alarm Detection	8-22
8.3.7 Analog Monitor Signal	8-23
8.3.8 Speed Feedback Method during Fully-closed Loop Control	8-23

8.1 System Configuration and Connection Example for SERVOPACK with Fully-closed Loop Control

This section describes the system configuration and connection example for the SERVOPACK with fully-closed loop control.

8.1.1 System Configuration

The following figure shows an example of the system configuration.

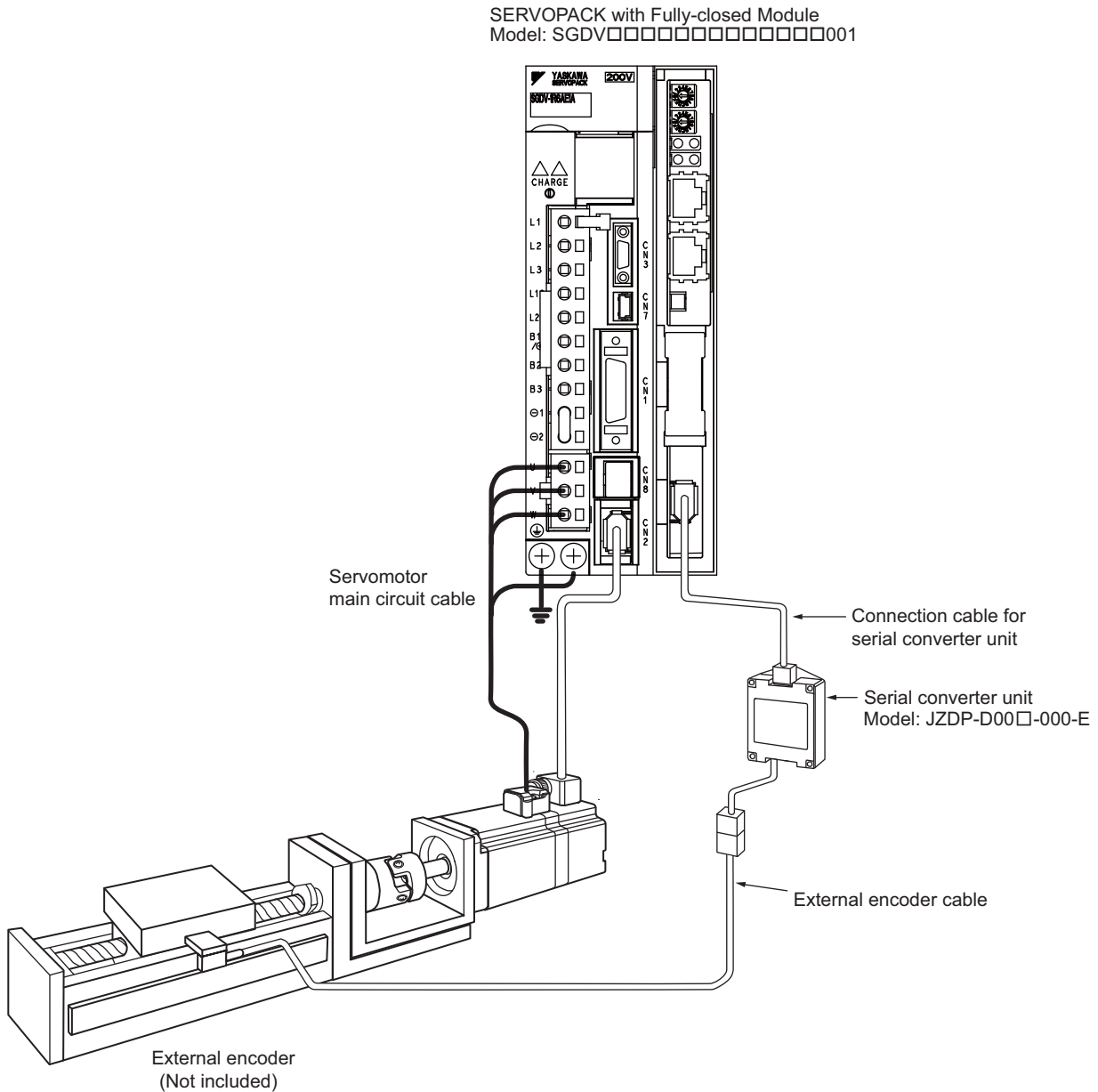

- Note 1. The figure above shows a connection example of an external encoder. Refer to *1.6 Examples of Servo System Configurations* for details on the power supply and peripheral devices.
2. In fully-closed loop control, rattling or twisting of mechanical parts may cause vibration, delaying the positioning process.

8.1.2 Internal Block Diagram of Fully-closed Loop Control

Internal block diagram of fully-closed loop control is shown below.

■ With Position Control

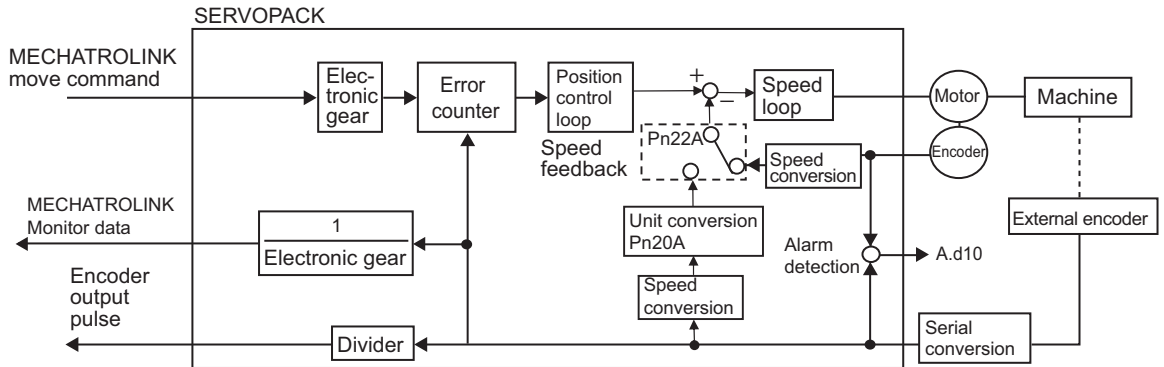

Note: Either an incremental or an absolute encoder can be used. When the absolute encoder is used, set 1 to Pn002.2 (use the absolute encoder as an incremental encoder).

■ With Speed Control

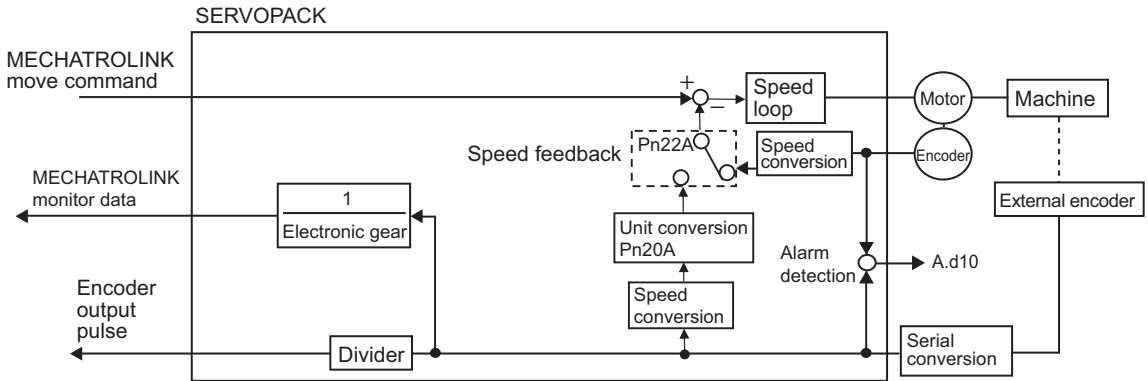

8.1.3 Serial Converter Unit

This section provides the specification of the serial converter unit.

(1) Model: JZDP-D00□-□□□-E

■ Characteristics and Specifications

Items		Specifications
Electrical Characteristics	Power Supply Voltage	+5.0 V±5%, ripple content 5% max.
	Current Consumption	120 mA Typ. 350 mA max.
	Signal Resolution	1/256 pitch (1 cycle) of input 2-phase sine wave pitch
	Max. Response Frequency	250 kHz
	Analog Input Signals* (cos, sin, Ref)	Differential input amplitude: 0.4 V to 1.2 V Input signal level: 1.5 V to 3.5 V
	Output Signal	Position data, alarms
	Output Method	Serial data communications
	Output Circuit	Balanced type transceiver (SN75LBC176 or the equivalent), internal terminating resistor: 120 Ω
Mechanical Characteristics	Approx. Mass	150 g
	Vibration Resistance	98 m/s ² max. (10 to 2500 Hz) in three directions
	Shock Resistance	980 m/s ² , (11 ms) two times in three directions
Environmental Conditions	Surrounding air Temperature	0°C to 55°C
	Storage Temperature	-20°C to +80°C
	Humidity	20% to 90%RH (without condensation)
	Altitude	1000 m max.

* Input a value within the specified range. Otherwise, incorrect position information is output, and the device may be damaged.

(2) Analog Signal Input Timing

When the cos and sin signals are shifted 180 degrees, the differential signals are produced as the /cos and /sin signals. The specifications of the cos, /cos, sin, and /sin signals are identical except for the phase.

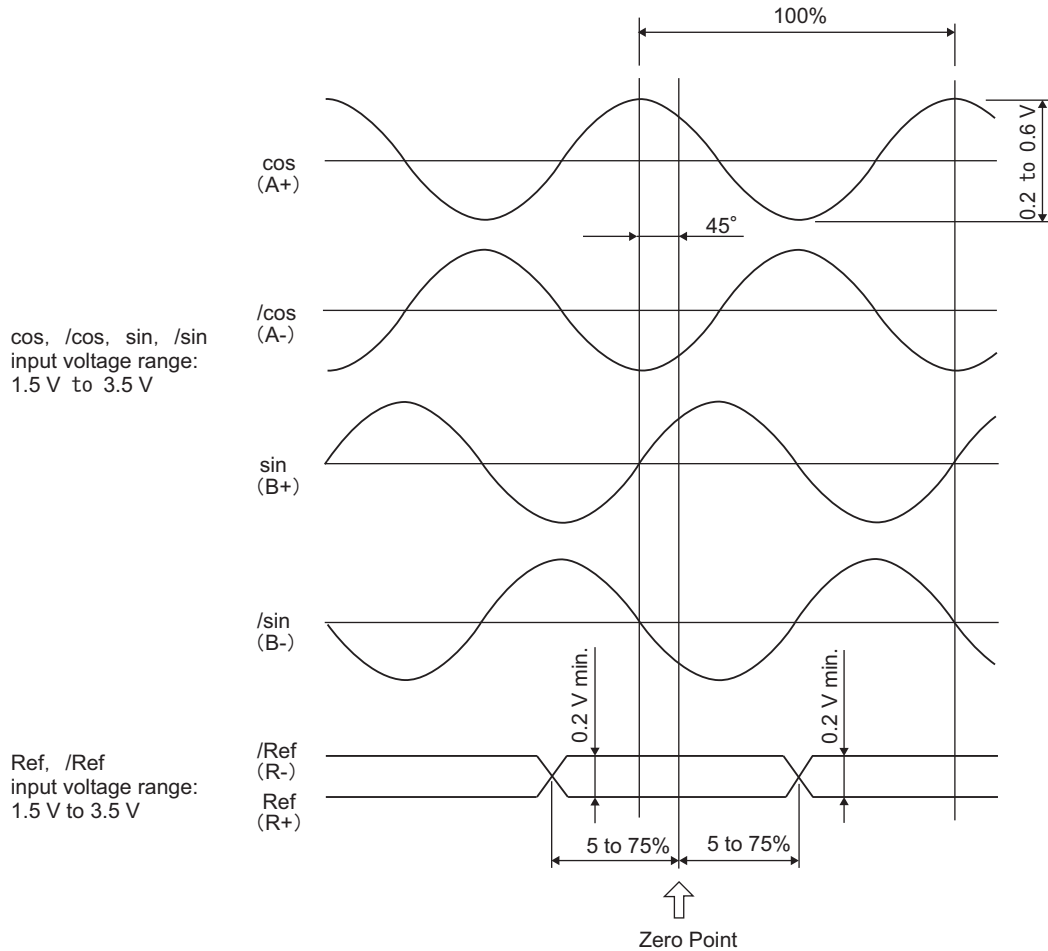

IMPORTANT

- Never perform insulation resistance and withstand voltage tests.
- When low-voltage analog signals are input to the serial converter unit, noise influence on the analog signals affects the unit's ability to output correct position information. The analog cable must be as short as possible and shielded.
- Do not connect or disconnect the unit while power is being supplied, or the unit may be damaged.
- When using multiple axes, use a shielded cable for each axis. Do not use a shielded cable for multiple axes.

8.1.4 Example of Connections to External Encoders

(1) External Encoder by Heidenhain

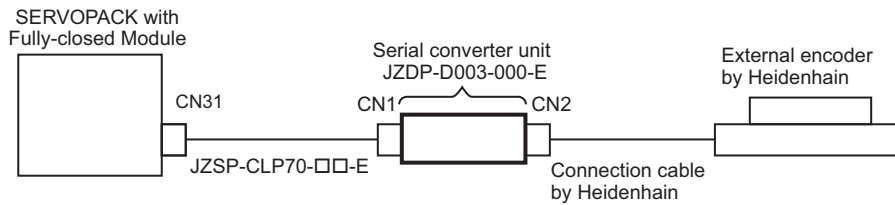

(2) External Encoder by Renishaw plc

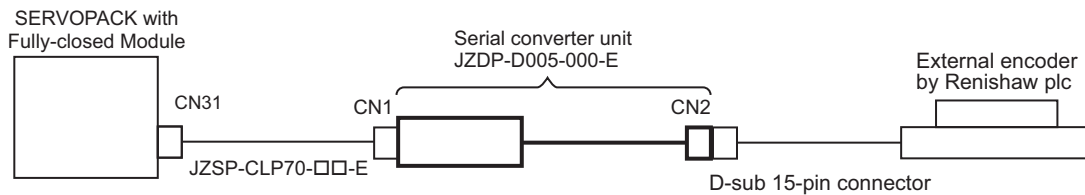

(3) External Encoder by Mitutoyo Corporation

The serial converter unit is not needed when using the external encoder made by Mitutoyo Corporation. This external encoder is an absolute encoder.

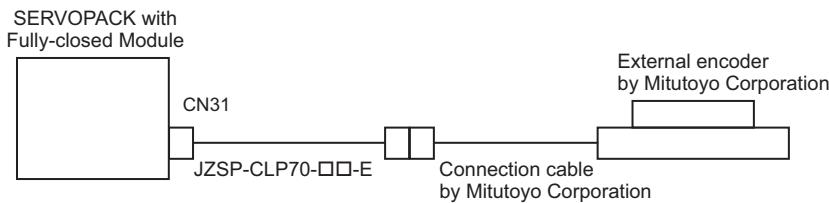

(4) External Encoder by Magnescale Co., Ltd.

■ Model: SR75, SR85, SR77*1, SR87*1, RU77*2

The serial converter unit is not needed when using the external encoder made by Magnescale Co., Ltd.

*1. The SR77 and SR87 models are external absolute encoder.

*2. The RU77 is rotational external absolute encoder.

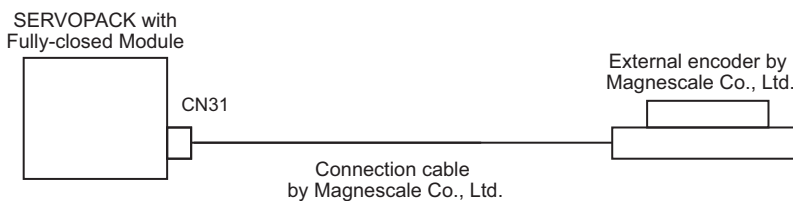

■ Model: SL700, SL710, SL720, SL730

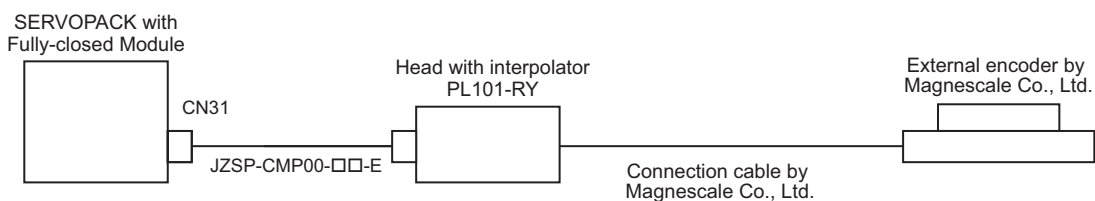

8.1.5 Encoder Output Pulse Signals from SERVOPACK with an External Encoder by Renishaw plc

The output position of the zero point signal (Ref) will depend on the direction of movement for some models of external encoders by Renishaw plc.

In such case, the phase-C pulses of the SERVOPACK are output at two positions.

For details on the specifications of the zero-point signals for a external encoder, refer to the manual for the Renishaw external encoder.

- (1) When Passing 1st Zero Point Signal (Ref) in Forward Direction and Returning after Power ON

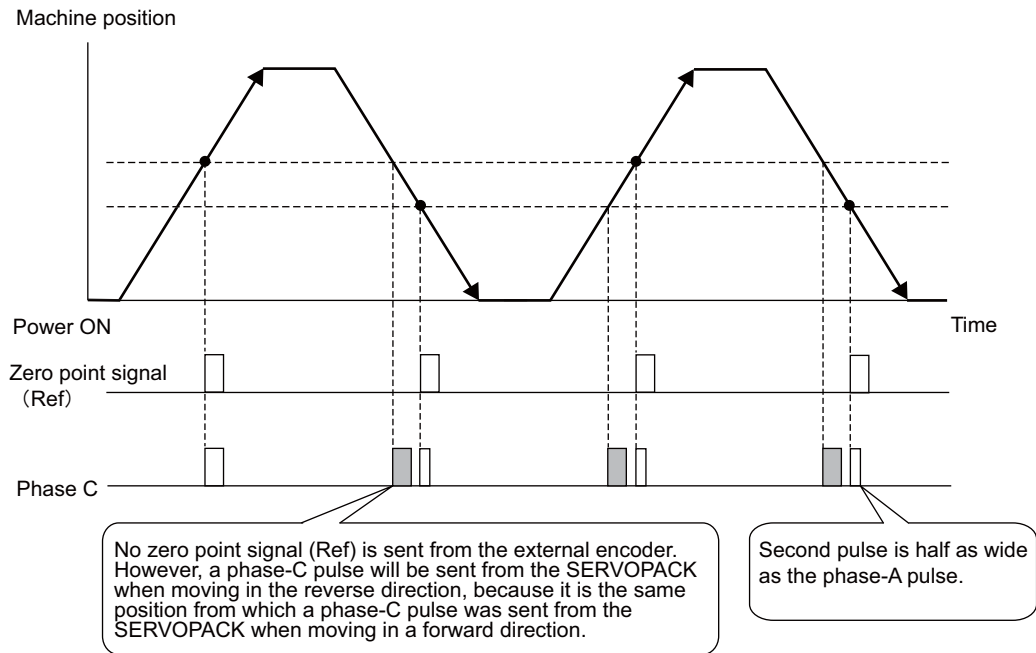

- (2) When Passing 1st Zero Point Signal (Ref) in Reverse Direction and Returning after Power ON

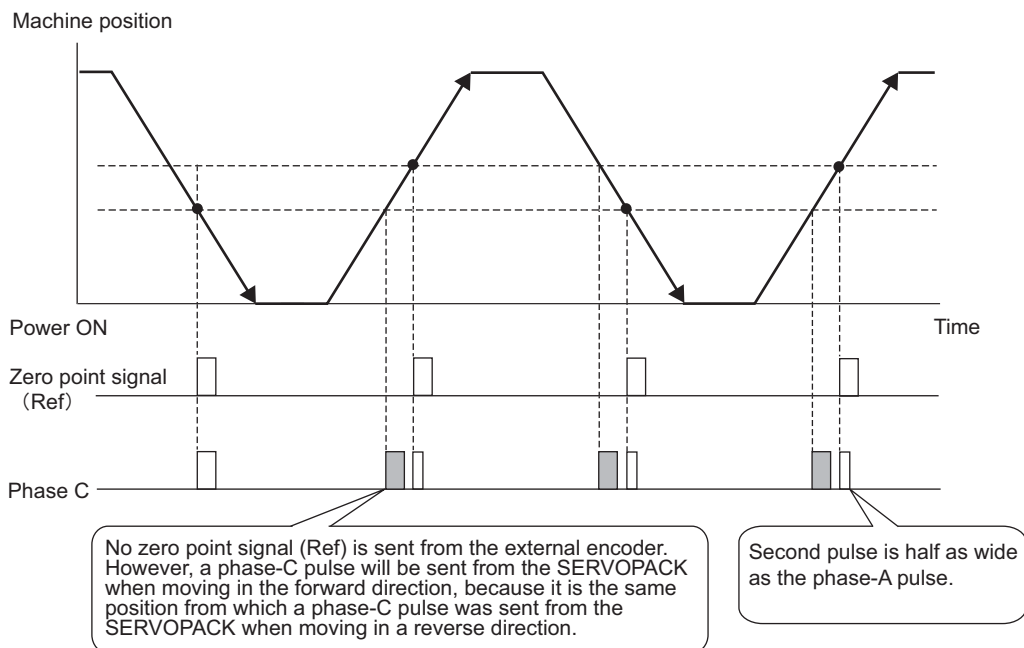

8.1.6 Precautions When Using an External Incremental Encoder by Magnescale

When an external incremental encoder by Magnescale Co., Ltd. is used, the count direction of the encoder determines if a phase-C pulse (CN1-21, CN1-22) is output and counted.

Note: The count direction (counting up or down) of the encoder determines if a phase-C pulse is output. The output of the pulse does not depend on the settings of these parameters: Pn000.0 (motor rotational direction) and Pn002.3 (external encoder usage method).

Model	Interpolator	Scale pitch (μm)
SL710	PL101-RY	800
SL720		800
SL730		800
SR75		80
SR85		80

■ When Passing 1st Zero Point in Forward Direction and Returning after Power ON

After the power is turned on, the phase-C pulse (CN1-21, CN1-22) is output when the external encoder moves forward and its detection head first passes the phase-C detection position. After the detection head of the encoder passes the detection position in a forward direction, the phase-C pulse is output when the head passes the position regardless of the direction of the encoder's movement.

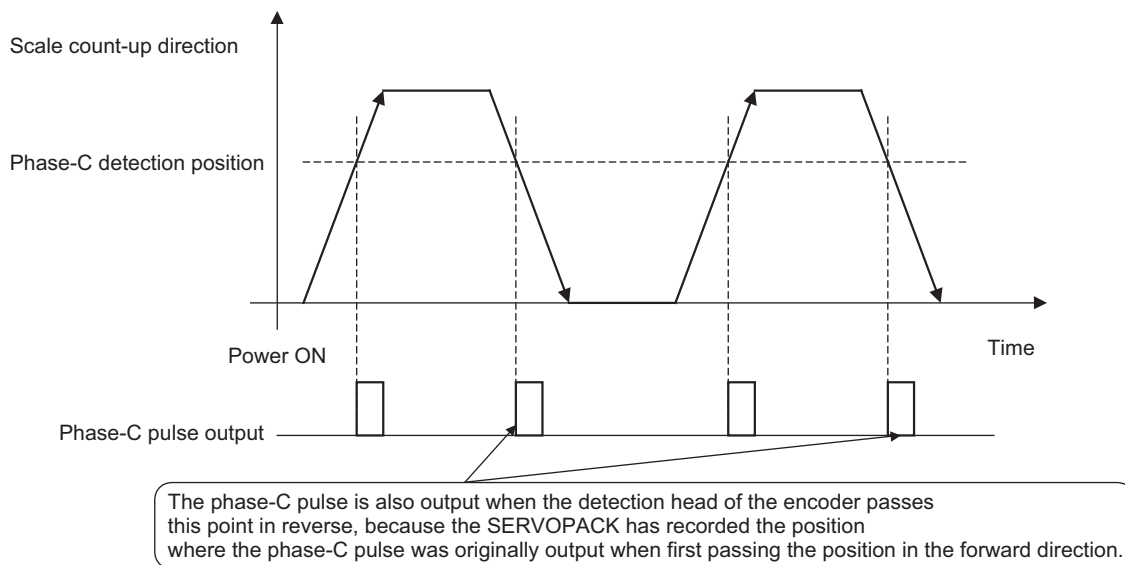

■ When Passing 1st Zero Point in Reverse Direction and Returning after Power ON

After the power is turned on, the phase-C pulse (CN1-21, CN1-22) is not output when the external encoder moves reverse and its head first passes the phase-C detection position. The phase-C pulse is output for the first time when the external encoder moves forward and its head passes the detection position. After the detection head of the encoder first passes the detection position in the forward direction, the phase-C pulse is output when the head passes the position regardless of the direction of the encoder's movement.

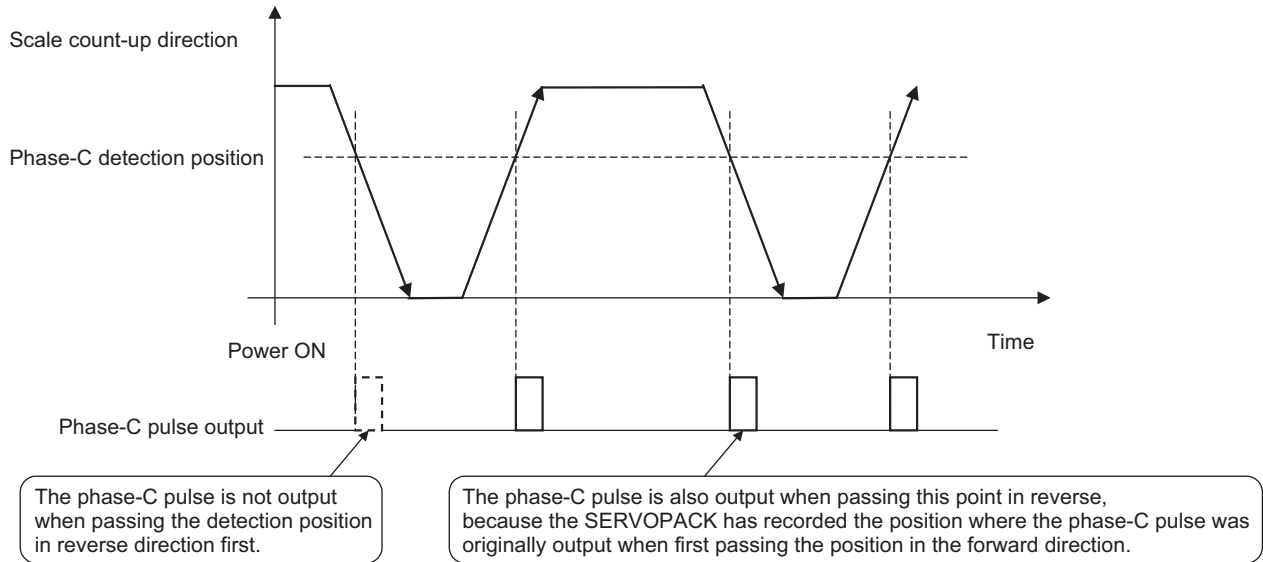

■ When Using an External Encoder with Multiple Zero Points and Passing 1st Zero Point in Forward Direction and Returning after Power ON

When using an external encoder with multiple zero points, the same logic as that explained earlier for an encoder with only one zero point applies to each zero point.

See ■ *When Passing 1st Zero Point in Forward Direction and Returning after Power ON*.

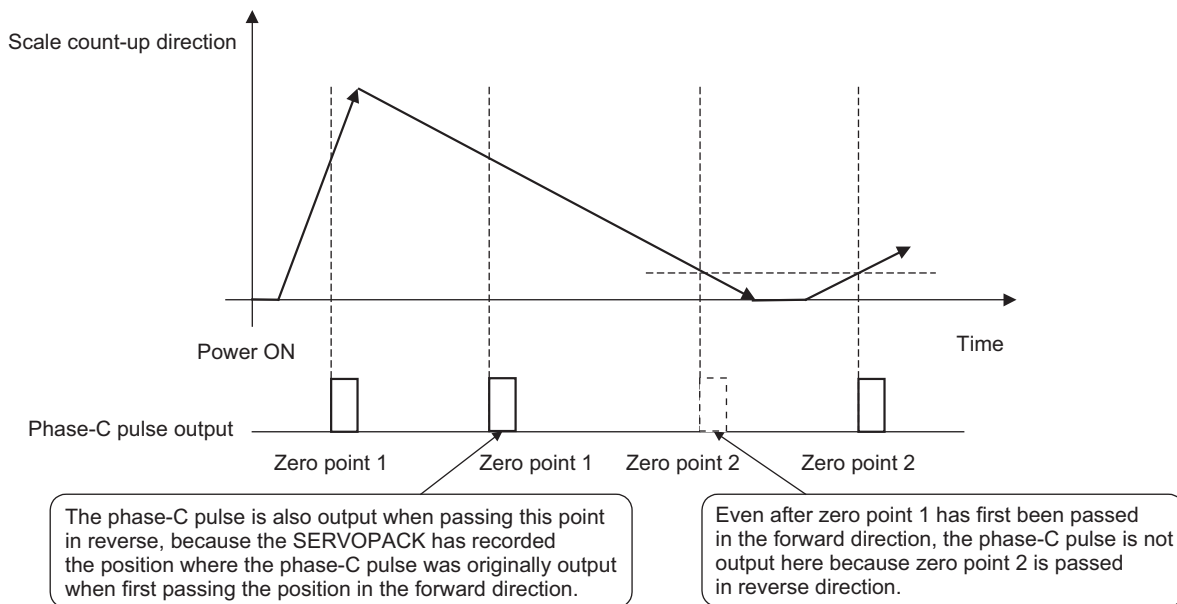

■ When Using an External Encoder with Multiple Zero Points and Passing 1st Zero Point in Reverse Direction and Returning after Power ON

When using an external encoder with multiple zero points, the same logic as that explained earlier for an encoder with only one zero point applies to each zero point.

See ■ *When Passing 1st Zero Point in Reverse Direction and Returning after Power ON*.

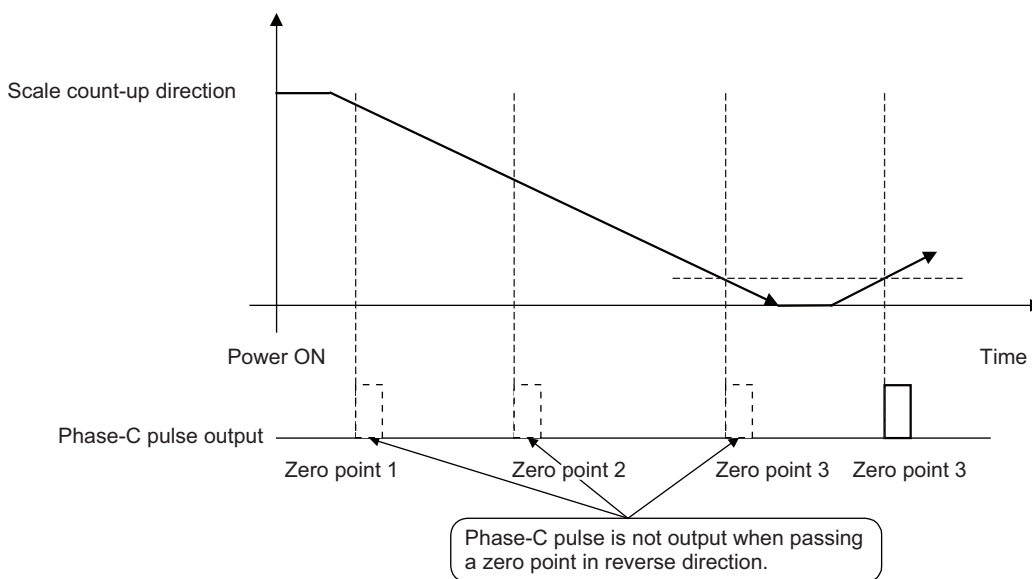

To output the phase-C pulse when a detection point is passed in reverse, set the following parameter to 1.

Parameter	Meaning	When Enabled	Classification
Pn081	n.□□□0 [Factory Setting]	Outputs phase-C pulse only in forward direction.	After restart Setup
	n.□□□1	Outputs phase-C pulse in forward and reverse direction.	

Note: A SERVOPACK with software version 0023 or later supports this parameter.



IMPORTANT

- Setting of Pn081.0
Do not change the factory setting if the zero point position of the existing equipment must remain as is.
- When Pn081.0=1, the width of the phase-C pulse output is narrower than that of the phase-A pulse in some cases.
- As shown in the following figure, there is a one-eighth scale pitch difference in positions between the two settings (Pn081.0=1 and Pn081.0=0) for the phase-C pulse output, the zero point return command, and the phase-C detection by phase-C latch function.

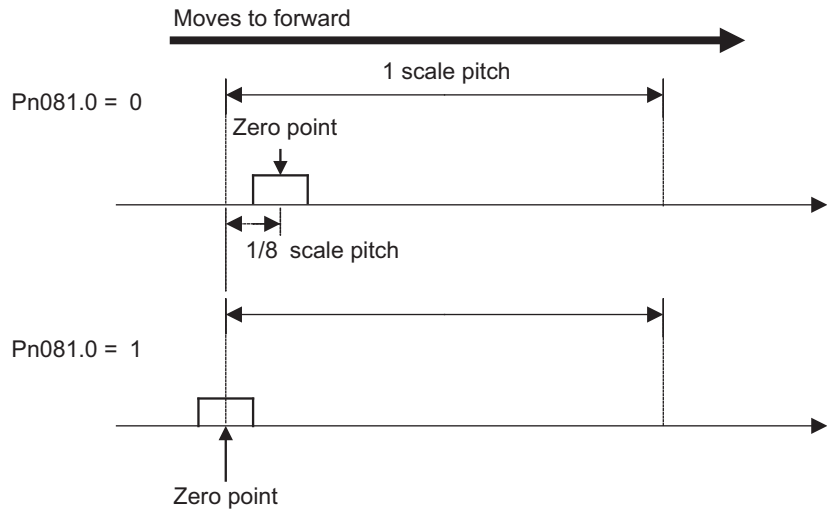

8.2 SERVOPACK Startup Procedure

First check that the SERVOPACK operates correctly with semi-closed loop control, then check that it operates correctly with fully-closed loop control.

The following describes the startup procedure for the SERVOPACK in fully-closed loop control.

Procedure	Description	Operation	Parameters Requiring Settings	Controller
1	<p>Check operation of the whole sequence in semi-closed loop control and without any load.</p> <p>Items to Check</p> <ul style="list-style-type: none"> • Power supply circuit wiring • Servomotor wiring • Encoder wiring • Wiring of I/O signal lines from the host controller • Servomotor rotation direction, speed, and number of rotations • Operation of safety mechanisms, such as the brakes and the overtravel mechanism 	<p>Set the parameters so that the SERVOPACK operates correctly in semi-closed loop control (Pn002.3 = 0) without any load and check the following points.</p> <ul style="list-style-type: none"> • Is there an error with the SERVOPACK? • Does the JOG operation operate correctly when operating the SERVOPACK in standalone mode? • Do the I/O signals turn ON/OFF correctly? • Does the servomotor turn ON after the servo ON signal has been input? • Does the servomotor operate correctly when the position reference is input by the host controller? 	<ul style="list-style-type: none"> • Basic Function Select Switch 0 (Pn000) • Application Function Select Switch 1 (Pn001) • External Encoder Usage (Pn002.3) • Electronic Gear Ratio (Numerator) (Pn20E) • Electronic Gear Ratio (Denominator) (Pn210) • Input Signal Selection (Pn50A, Pn50B, Pn511) • Output Signal Selection (Pn50E, Pn50F, Pn510) 	SERVOPACK or host controller
2	<p>Check operation of the system connected with the machine and servomotor in semi-closed loop control mode.</p> <p>Items to Check</p> <ul style="list-style-type: none"> • Initial responsiveness of the system connected with the machine • Movement direction, distance, and speed of the machine specified by the host controller 	<p>Connect the servomotor to the machine.</p> <p>Set the moment of inertia ratio (Pn103) using the advanced auto-tuning function.</p> <p>Check that the machine operates in the correct direction, distance, and speed as directed by the host controller.</p>	<ul style="list-style-type: none"> • Moment of inertia ratio (Pn103) 	Host controller
3	<p>Check the external encoder.</p> <p>Item to Check</p> <ul style="list-style-type: none"> • Are signals from the external encoder received correctly? 	<p>Set parameters related to the fully-closed loop control and move the machine with your hand without turning ON the power supply to the servomotor. Check the following status with the digital operator or SigmaWin+.</p> <ul style="list-style-type: none"> • Does the fully-closed feedback pulse counter (Un00E) count up when the servomotor moves in the forward direction? • Is the distance the machine moved about visually the same as the amount counted by the fully-closed feedback pulse counter (Un00E)? <p>Note: The unit for fully-closed feedback pulse counter (Un00E) is one pulse, which is equivalent to the external encoder sine wave pitch divided by the number of divisions*.</p> <p>* Refer to 8.3.5 <i>Electronic Gear</i> for details on the number of divisions.</p>	<ul style="list-style-type: none"> • External Encoder Usage (Pn002.3) • Number of External Scale Pitch (Pn20A) • Electronic Gear Ratio (Numerator) (Pn20E) • Electronic Gear Ratio (Denominator) (Pn210) • Encoder Output Resolution (Pn281) • Excessive Error Level Between Servomotor and Load Positions (Pn51B) • Positioning Completed Width (Pn522) • Multiplier per One Fully-closed Rotation (Pn52A) 	—

(cont'd)

Procedure	Description	Operation	Parameters Requiring Settings	Controller
4	Perform a program JOG operation. Items to Check <ul style="list-style-type: none"> Does the fully-closed loop control operate correctly when operating the SERVOPACK in standalone mode? 	Perform a program JOG operation and check that the distance that the servomotor moved is the same as the distance that is set in Pn531. Note: Start from a low speed and gradually increase the speed.	<ul style="list-style-type: none"> Program JOG related parameters (Pn530 to Pn536) 	SERVOPACK
5	Operate the SERVOPACK. Items to Check <ul style="list-style-type: none"> Does the fully-closed loop control operate correctly including the host controller? 	Input the position reference and check that the SERVOPACK operates correctly. Note: Start from a low speed and gradually increase the speed.	—	Host controller

8.3 Parameter Settings for Fully-closed Loop Control

This section describes the parameter settings for fully-closed loop control.

Set Parameters	Setting Contents	Position Control	Speed Control	Torque Control	Reference
Pn000.0	Motor rotation direction	○	○	○	8.3.1
Pn002.3	External encoder usage method	○	○	○	
Pn20A	Number of pitches for the external encoder	○	○	○	8.3.2
Pn281	Number of encoder output pulses (PAO, PBO, and PCO) from the SERVOPACK	○	○	○	8.3.3
–	External absolute encoder data reception sequence	○	○	○	8.3.4
Pn20E, Pn210	Electronic gear ratio	○	–	–	8.3.5
Pn51B	Excessive error level between servomotor and load positions	○	–	–	8.3.6
Pn52A	Multiplier per one fully-closed rotation	○	–	–	
Pn006/Pn007	Analog monitor signal	○	○	○	8.3.7
Pn22A	Speed feedback method during fully-closed loop control	○	–	–	8.3.8

Note: When using an external absolute encoder, this external encoder works as an absolute encoder even if Pn002.2 is set to 1.

Parameter	Meaning	When Enabled	Classification
Pn002	n.□0□□ [Factory setting]	After restart	Setup
	n.□1□□		

8.3.1 Motor Rotation Direction

The motor rotation direction can be set. To perform fully-closed loop control, it is necessary to set the motor rotation direction with both Pn000.0 (motor rotation direction) and Pn002.3 (external encoder usage).

(1) Setting Parameter Pn000.0

The standard setting for forward rotation is counterclockwise (CCW) as viewed from the load end of the servomotor.

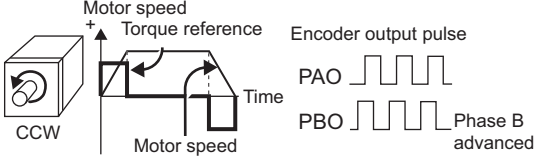
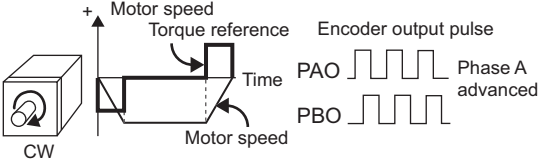
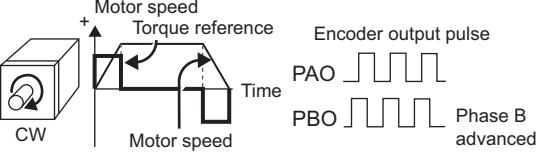
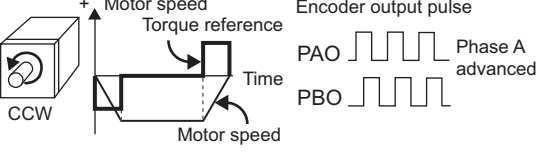
Parameter	Forward/Reverse Reference	Direction of Motor Rotation and Encoder Output Pulse	Applicable Overtravel (OT)
Pn000	n.□□□0 Sets CCW as forward direction. [Factory setting]	Forward Reference 	P-OT
		Reverse Reference 	N-OT
	n.□□□1 Sets CW as forward direction. (Reverse Rotation Mode)	Forward Reference 	P-OT
		Reverse Reference 	N-OT

Note: SigmaWin+ trace waveforms are shown in the above table.

(2) Setting Parameter Pn002.3

Parameter	Name	Meaning	When Enabled	Classification	
Pn002	n.0□□□ [Factory setting]	External Encoder Usage	Do not use external encoder.*	After restart	Setup
	n.1□□□		Use in forward rotation with forward reference.		
	n.2□□□		Reserved parameter (Do not change).		
	n.3□□□		Use in reversed rotation with forward reference.		
	n.4□□□		Reserved parameter (Do not change).		

* The mode will be switched to semi-closed position control if Pn002.3 is set to 0.

(3) Relation between Motor Rotation Direction and External Encoder Pulse Phases

Refer to the table below.

Parameter			Pn002.3 (External Encoder Usage)			
			1		3	
Pn000.0 (Motor rotation direction)	0	Reference direction	Forward reference	Reverse reference	Forward reference	Reverse reference
		Motor rotation direction	CCW	CW	CCW	CW
		External encoder output	cos lead	sin lead	sin lead	cos lead
		Encoder output pulse	Phase B lead	Phase A lead	Phase B lead	Phase A lead
	1	Reference direction	Forward reference	Reverse reference	Forward reference	Reverse reference
		Motor rotation direction	CW	CCW	CW	CCW
		External encoder output	sin lead	cos lead	cos lead	sin lead
		Encoder output pulse	Phase B lead	Phase A lead	Phase B lead	Phase A lead

- Set Pn002.3 to 1 (forward rotation with forward reference) if the output of the external encoder is cos lead and the motor is turning counterclockwise; set Pn002.3 to 3 (reverse rotation with forward reference) if it is sin lead. When Pn000.0 is set to 0 and Pn002.3 to 1, manually turn the motor shaft counterclockwise. If the fully-closed feedback pulse counter (Un00E) counts up, set Pn002.3 to 1. If the Un00E counts down, set Pn002.3 to 3.
- The output pulses are phase-B advanced if the motor is turning forward regardless of the setting in Pn000.0.

8.3.2 Sine Wave Pitch (Frequency) for an External Encoder

Set the number of external encoder pitches per motor rotation to Pn20A.

Pn20A is the speed conversion coefficient when the external encoder is used as speed feedback.

(1) Setting Example

Specifications External encoder sine wave pitch: 20 μm Ball screw lead: 30 mm

If the external encoder is connected directly to the motor, the set value will be 1500 (30 mm/0.02 mm = 1500).

- Note 1. If there is a fraction, round off the digits below the decimal point.
- 2. If the number of external encoder pitches per motor rotation is not an integer, there is some error in the speed loop. This is not relevant for the position loop however, therefore it does not interfere with the position accuracy.

(2) Related Parameter

Pn20A	Number of External Scale Pitch Position				Classifica- tion
	Setting Range	Setting Unit	Factory Setting	When Enabled	
	4 to 1048576	1 pitch/rev	32768	After restart	Setup

8.3.3 Setting Encoder Output Pulses (PAO, PBO, and PCO)

Set the position resolution to Pn281. Set the number of phase A and phase B edges.

(1) Setting Example

Specifications External encoder sine wave pitch: 20 μm Ball screw lead: 30 mm Speed: 1600 mm/s

If the output of a single pulse (multiplied by 4) is 1 μm, the set value will be 20.

If the output of a single pulse (multiplied by 4) is 0.5 μm, the set value will be 40.

The encoder output pulse will have the following waveform if the set value is 20.

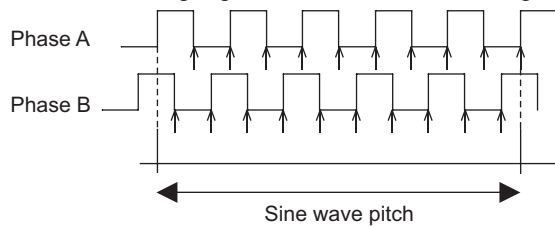

"↑" shows the edge position. In this example, the set value is 20 therefore the number of ↑ is 20.

Note: The upper limit of the encoder signal output frequency (multiplied by 4) is 6.4 Mpps. Do not set a value that would cause the output to exceed 6.4 Mpps. If the output exceeds the upper limit, the overspeed of encoder output pulse rate alarm (A.511) will be output.

Example:
The frequency is as follows if the set value is 20 and the speed is 1600 mm/s:

$$\frac{1600 \text{ mm/s}}{0.001 \text{ mm}} = 1600000 = 1.6 \text{ Mpps}$$

Because 1.6 Mpps is less than 6.4 Mpps, this value can be used.

(2) Related Parameter

Pn281	Encoder Output Resolution Position				Classification
	Setting Range	Setting Unit	Factory Setting	When Enabled	
	1 to 4096	1 edge/pitch	20	After restart	Setup

Note: The maximum setting for the encoder output resolution is 4096. When the number of divisions on the external encoder is more than 4096, the data shown in 8.3.5 ■ *External Encoder Sine Wave Pitch and Number of Divisions* is no longer applicable.

(3) Phase-C Pulse Output Specifications

The pulse width of phase C (origin pulse) varies according to the encoder output resolution (Pn281), and will become the same as the pulse width of phase A.

Output timing for the phase-C pulse is one of the following.

- In synchronization with the phase-A rising edge
- In synchronization with the phase-A falling edge
- In synchronization with the phase-B rising edge
- In synchronization with the phase-B falling edge

8.3.4 External Absolute Encoder Data Reception Sequence

The sequence in which the SERVOPACK receives outputs from the external absolute encoder and transmits them to host controller in fully-closed loop control is shown below.

(1) Outline of Absolute Signals

The serial data, pulses, etc., of the external absolute encoder that are output from the SERVOPACK are output from the PAO, PBO, and PCO signals as shown below.

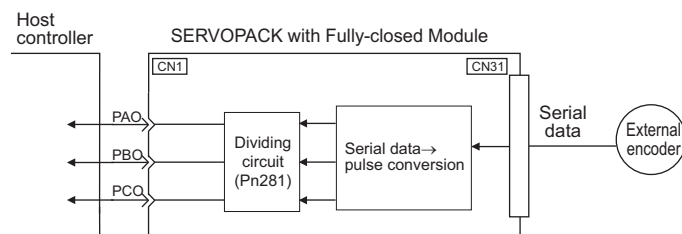

Signal Name	Status	Contents
PAO	At initialization	Serial data Initial incremental pulses
	Normal Operations	Incremental pulses
PBO	At initialization	Initial incremental pulses
	Normal Operations	Incremental pulses
PCO	Always	Origin pulses

Note: When host controller receives the data from the external absolute encoder, do not perform counter reset using the output of PCO signal.

(2) Absolute Data Transmission Sequence and Contents

1. Send the sensor ON command from the host controller.
2. After 100 ms, set the system to serial data reception-waiting-state. Clear the incremental pulse up/down counter to zero.
3. Receive eight characters of serial data.
4. The system enters a normal incremental operation state about 400 ms after the last serial data is received.

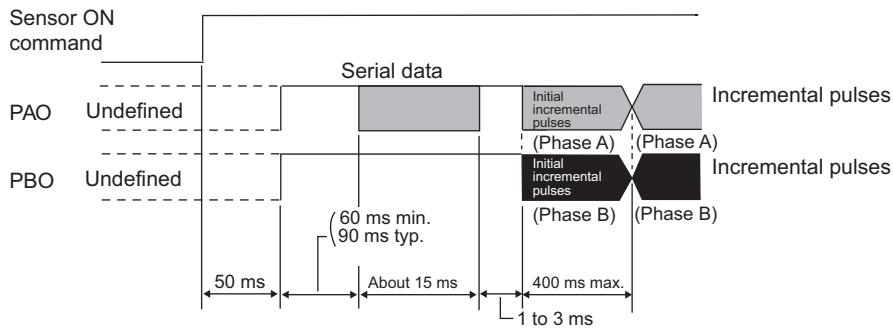

Serial data:

The current position pulses divided by Pn281 are output in serial data. One serial data is a value equivalent to 1048576 pulses.

Initial incremental pulses:

The current position pulses divided by Pn281 are output in pulses. The number of output pulses is between 0 to 1048576, and the output speed is approximately 1.48 μs per pulse.

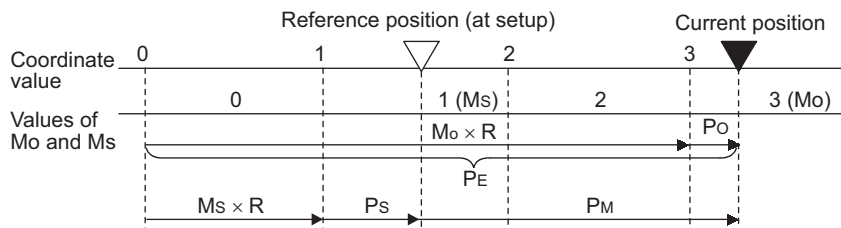

Final absolute data P_M is calculated by following formula.

$$P_E = M_O \times R + P_O$$

$$P_M = P_E - M_S \times R - P_S$$

Signal	Meaning
P_E	Current position of external encoder
M_O	Serial data of current position
P_O	Number of initial incremental pulses of current position
M_S	Serial data of reference position
P_S	Number of initial incremental pulses of reference position
P_M	Current value required for the user's system
R	1048576

Note: If host controller receives the data from the external absolute encoder, do not perform counter reset using the output of PCO signal.

(3) Serial Data Specifications

The serial data is output from the PAO signal.

Data Transfer Method	Start-stop Synchronization (ASYNC)
Baud rate	9600 bps
Start bits	1 bit
Stop bits	1 bit
Parity	Even
Character code	ASCII 7-bit code
Data format	<p>8 characters, as shown below.</p> <p>Note: 1. Data is "P+00000" (CR) or "P-00000" (CR) when the position is zero. 2. The serial data range is "-32768" to "+32767". When this range is exceeded, the data changes from "+32767" to "-32678" or from "-32768" to "+32767." When changing multiturn limit, the range changes. For details, refer to 4.5.6 Multiturn Limit Setting.</p>

(4) Transferring Alarm Contents

If an external absolute encoder is used, the contents of alarms detected by the SERVOPACK are transmitted in serial data to the host controller from the PAO output when the sensor ON command is changed from ON to OFF.

Note: The sensor ON command cannot be turned OFF while the servomotor power is ON.

Output example of alarm contents are as shown below.

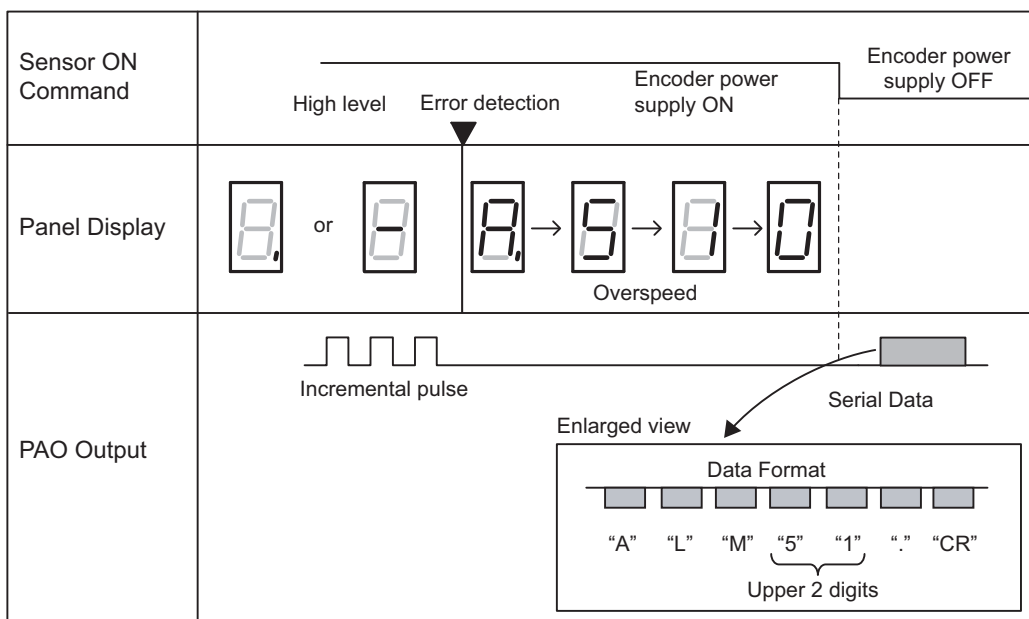

8.3.5 Electronic Gear

Refer to 4.2.4 *Electronic Gear* for the purpose of setting the electronic gear.

The following formula is used to calculate the electronic gear ratio in fully-closed loop control.

$$\text{Electronic gear ratio} \frac{B}{A} = \frac{Pn20E}{Pn210} = \frac{\text{Travel distance per position reference (reference unit)} \times \text{Number of divisions}}{\text{External encoder sine wave pitch}}$$

Note: Set Pn20E (numerator B) and Pn210 (denominator A) to integral values.

The setting range is defined by $0.001 \leq \frac{B}{A} \leq 4000$.

The following table shows the various external encoder sine wave pitches and the number of divisions.

■ External Encoder Sine Wave Pitch and Number of Divisions

Calculate the electronic gear ratio with the values in the following table.

Type of External Encoder	Manufacturer	External Encoder Model	Sine Wave Pitch [μm]	Models for Serial Converter Unit or Models for Head with Interpolator	Number of Divisions	Resolution
Incremental	Heidenhain	LIDA48□	20	JZDP-D003-□□□-E*1	256	0.078 μm
		LIDA18□	40	JZDP-D003-□□□-E*1	256	0.156 μm
		LIF48□	4	JZDP-D003-□□□-E*1	256	0.016 μm
	Renishaw plc	RGH22B	20	JZDP-D005-□□□-E*1	256	0.078 μm
	Magnescale Co., Ltd.	SR75-□□□□□LF*4	80	—	8192	0.0098 μm
		SR75-□□□□□MF	80	—	1024	0.078 μm
		SR85-□□□□□LF*4	80	—	8192	0.0098 μm
		SR85-□□□□□MF	80	—	1024	0.078 μm
		SL700*4, SL710*4, SL720*4, SL730*4	800	PL101-RY*2	8192	0.0977 μm
	Absolute	Mitutoyo Corporation	ST781A/ST781AL	256	—	512
ST782A/ST782AL			256	—	512	0.5 μm
ST783/ST783AL			51.2	—	512	0.1 μm
ST784/ST784AL			51.2	—	512	0.1 μm
ST788A/ST788AL			51.2	—	512	0.1 μm
ST789A/ST789AL*5			25.6	—	512	0.05 μm
Magnescale Co., Ltd.		SR77-□□□□□LF*4	80	—	8192	0.0098 μm
		SR77-□□□□□MF	80	—	1024	0.078 μm
		SR87-□□□□□LF*4	80	—	8192	0.0098 μm
		SR87-□□□□□MF	80	—	1024	0.078 μm
		RU77-4096ADF*3	—	—	256	20 bits
RU77-4096AFFT01*3	—	—	1024	22 bits		

*1. Models for serial converter units.

*2. Models for heads with interpolators.

*3. Models for rotational external encoders.

*4. When using the encoder pulse output with these external encoders, the setting range of Pn281 is restricted. For details, refer to 8.3.3 *Setting Encoder Output Pulses (PAO, PBO, and PCO)*.

*5. For details on this external encoder, contact Mitutoyo.

Refer to the manuals for the external encoder and serial converter unit for details on the sine wave pitch and the number of divisions of the external encoder.

■ Setting Example

If the servomotor moves 0.2 μm for every pulse of position reference, the external encoder sine wave pitch is 20 μm, and the number of divisions is 256, the electronic gear ratio will be as follow.

$$\text{Electronic gear ratio } \frac{B}{A} = \frac{\text{Pn20E}}{\text{Pn210}} = \frac{0.2 \times 256}{20} = \frac{512}{200}$$

Therefore, set 512 for Pn20E (numerator B) and 200 for Pn210 (denominator A).

8.3.6 Alarm Detection

The setting of alarm detection (Pn51B/Pn52A) is shown below.

(1) Excessive Error Level between Servomotor and Load Positions (Pn51B)

This setting detects the difference between the feedback position of the motor encoder and the feedback load position of the external encoder in fully-closed loop control. If the detected difference is above the set level, the motor-load position error overflow alarm (A.d10) will be output.

Pn51B	Excessive Error Level between Servomotor and Load Positions Position				Classification
	Setting Range	Setting Unit	Factory Setting	When Enabled	
	0 to 1073741824	1 reference unit	1000	Immediately	Setup

Note: When Pn51B is set to 0, the motor-load position error overflow alarm (A.d10) is not detected.

(2) Multiplier per One Fully-closed Rotation (Pn52A)

The coefficient of the error between the external encoder and the motor per motor rotation can be set. This function can be used to prevent the motor from running out of control due to damage to the external encoder or to detect slippage of the belt.

■ Setting Example

Increase the value if the belt slips or is twisted excessively.

If the set value is 0, the external encoder value will be read as it is.

If the factory setting of 20 is used, the second rotation will start with the error for the first motor rotation multiplied by 0.8. (Refer to the following figure.)

Error between motor and external encoder

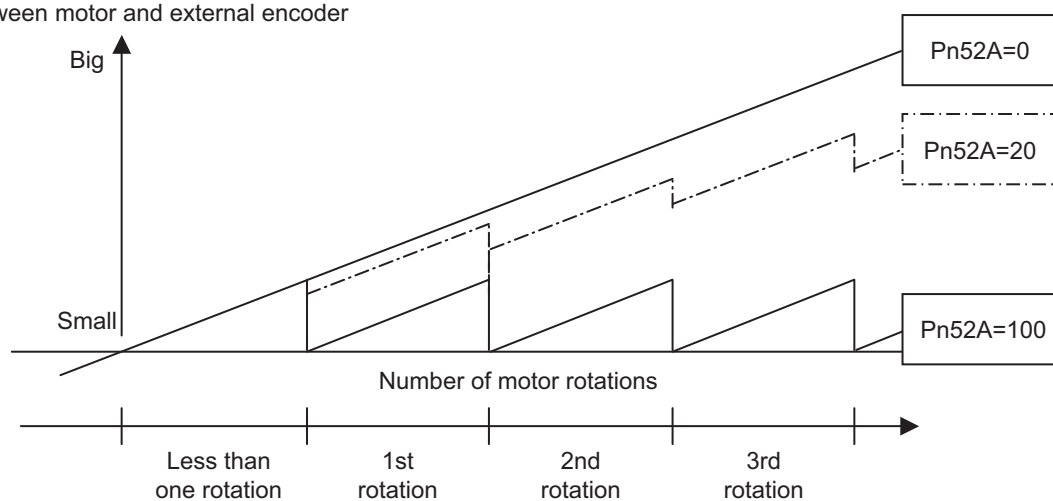

■ Related Parameter

Pn52A	Multiplier per One Fully-closed Rotation Position				Classification
	Setting Range	Setting Unit	Factory Setting	When Enabled	
	0 to 100	1%	20	Immediately	Setup

8.3.7 Analog Monitor Signal

The position error between servomotor and load can be monitored with the analog monitor.

Parameter	Name	Meaning	When Enabled	Classification
Pn006	n.□□07	Analog Monitor 1 Signal Selection	Immediately	Setup
Pn007	n.□□07	Analog Monitor 2 Signal Selection		

8.3.8 Speed Feedback Method during Fully-closed Loop Control

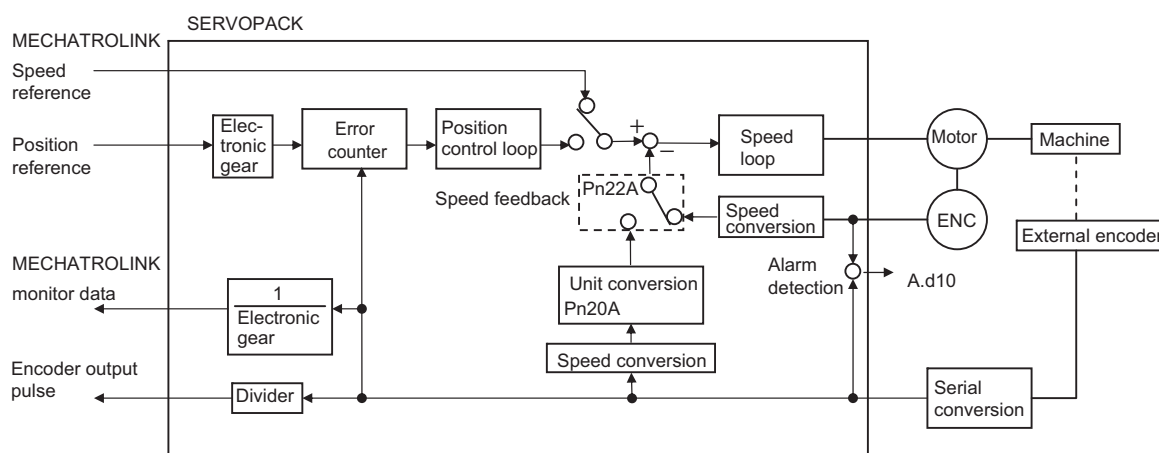

Use Pn22A.3 to select the speed feedback method during fully-closed loop control: Normally, set Pn22A.3 to 0 (Uses motor encoder speed.). Set Pn22A.3 to 1 (Uses external encoder speed.) when connecting a direct drive motor and high-resolution external encoder.

Parameter	Meaning	When Enabled	Classification
Pn22A	n.0□□□ [Factory setting]	After restart	Setup
	n.1□□□		

Note: This parameter cannot be used when Pn002.3 is set to 0.

Troubleshooting

9.1 Troubleshooting	9-2
9.1.1 List of Alarms	9-2
9.1.2 Troubleshooting of Alarms	9-6
9.2 Warning Displays	9-22
9.2.1 List of Warnings	9-22
9.2.2 Troubleshooting of Warnings	9-24
9.3 Troubleshooting Malfunction Based on Operation and Conditions of the Servomotor	9-28

9.1 Troubleshooting

The following sections describe troubleshooting in response to alarm displays.

The alarm name, alarm meaning, alarm stopping method, and alarm reset capability are listed in order of the alarm numbers in *9.1.1 List of Alarms*.

The causes of alarms and troubleshooting methods are provided in *9.1.2 Troubleshooting of Alarms*.

9.1.1 List of Alarms

If an alarm occurs, the servomotor can be stopped by doing either of the following operations.

■ Alarm Stopping Method

Gr.1: The servomotor is stopped according to the settings in Pn001.0 if an alarm occurs. Pn001.0 is factory-set to stop the servomotor by applying the DB.

Gr.2: The servomotor is stopped according to the setting in Pn00B.1 if an alarm occurs. Pn00B.1 is factory-set to stop the servomotor by setting the speed reference to "0." The servomotor under torque control will always use the Gr.1 method to stop. By setting Pn00B.1 to 1, the servomotor stops using the same method as Gr.1. When coordinating a number of servomotors, use this alarm stop method to prevent machine damage that may result due to differences in the stop method.

■ Alarm Reset Capability

Available: Removing the cause of alarm and then executing the alarm reset can clear the alarm.

N/A: Executing the alarm reset cannot clear the alarm.

Alarm Display	Alarm Name	Meaning	Servomotor Stop Method	Alarm Reset
A.020	Parameter Checksum Error	The data of the parameter in the SERVOPACK is incorrect.	Gr.1	N/A
A.021	Parameter Format Error	The data format of the parameter in the SERVOPACK is incorrect.	Gr.1	N/A
A.022	System Checksum Error	The data of the parameter in the SERVOPACK is incorrect.	Gr.1	N/A
A.030	Main Circuit Detector Error	Detection data for power circuit is incorrect.	Gr.1	Available
A.040	Parameter Setting Error	The parameter setting is outside the allowable setting range.	Gr.1	N/A
A.041	Encoder Output Pulse Setting Error	The encoder output pulse setting (pulse unit) (Pn212) is outside the allowable setting range or does not satisfy the setting conditions.	Gr.1	N/A
A.042	Parameter Combination Error	Combination of some parameters exceeds the setting range.	Gr.1	N/A
A.044	Fully-closed Loop Control Parameter Setting Error	The settings of the fully-closed option module and Pn00B.3, Pn002.3 do not match.	Gr.1	N/A
A.04A	Parameter Setting Error 2	There is an error in settings of parameters reserved by the system.	Gr.1	N/A
A.050	Combination Error	The SERVOPACK and the servomotor capacities do not match each other.	Gr.1	Available
A.051	Unsupported Device Alarm	The unsupported device unit was connected.	Gr.1	N/A
A.0b0	Cancelled Servo ON Command Alarm	The host controller reference was sent to turn the Servo ON after the Servo ON function was used with the utility function.	Gr.1	Available
A.100	Overcurrent or Heat Sink Overheated	An overcurrent flowed through the IGBT. Heat sink of the SERVOPACK was overheated.	Gr.1	N/A
A.300	Regeneration Error	Regenerative circuit or regenerative resistor is faulty.	Gr.1	Available
A.320	Regenerative Overload	Regenerative energy exceeds regenerative resistor capacity.	Gr.2	Available
A.330	Main Circuit Power Supply Wiring Error	<ul style="list-style-type: none"> Setting of AC input/DC input is incorrect. Power supply wiring is incorrect. 	Gr.1	Available
A.400	Overvoltage	Main circuit DC voltage is excessively high.	Gr.1	Available

(cont'd)

Alarm Display	Alarm Name	Meaning	Servomotor Stop Method	Alarm Reset
A.410	Undervoltage	Main circuit DC voltage is excessively low.	Gr.2	Available
A.450	Main-Circuit Capacitor Overvoltage	The capacitor of the main circuit has deteriorated or is faulty.	Gr.1	N/A
A.510	Overspeed	The servomotor speed is over the maximum allowable speed.	Gr.1	Available
A.511	Overspeed of Encoder Output Pulse Rate	The set value of the encoder output pulse (Pn212) exceeds the speed limit.	Gr.1	Available
A.520	Vibration Alarm	Vibration at the motor speed was detected.	Gr.1	Available
A.521	Autotuning Alarm	Vibration was detected while performing tuning-less function.	Gr.1	Available
A.710	Overload: High Load	The motor was operating for several seconds to several tens of seconds under a torque largely exceeding ratings.	Gr.2	Available
A.720	Overload: Low Load	The motor was operating continuously under a torque largely exceeding ratings.	Gr.1	Available
A.730 A.731	Dynamic Brake Overload	When the dynamic brake was applied, rotational energy exceeded the capacity of dynamic brake resistor.	Gr.1	Available
A.740	Overload of Surge Current Limit Resistor	The main circuit power was frequently turned ON and OFF.	Gr.1	Available
A.7A0	Heat Sink Overheated	The temperature of the SERVOPACK heat sink exceeded 100°C.	Gr.2	Available
A.7AB	Built-in Fan in SERVOPACK Stopped	The fan inside the SERVOPACK stopped.	Gr.1	Available
A.810	Encoder Backup Error	All the power supplies for the absolute encoder have failed and position data was cleared.	Gr.1	N/A
A.820	Encoder Checksum Error	The checksum results of encoder memory is incorrect.	Gr.1	N/A
A.830	Absolute Encoder Battery Error	The battery voltage is lower than the specified value after the control power supply is turned ON.	Gr.1	Available
A.840	Encoder Data Error	Data in the encoder is incorrect.	Gr.1	N/A
A.850	Encoder Overspeed	The encoder was rotating at high speed when the power was turned ON.	Gr.1	N/A
A.860	Encoder Overheated	The internal temperature of encoder is too high.	Gr.1	N/A
A.8A0*	External Encoder Error	External encoder is faulty.	Gr.1	Available
A.8A1*	External Encoder Error of Module	Serial converter unit is faulty.	Gr.1	Available
A.8A2*	External Encoder Error of Sensor (Incremental)	External encoder is faulty.	Gr.1	Available
A.8A3*	External Encoder Error of Position (Absolute)	The external encoder position data is incorrect.	Gr.1	Available
A.8A5*	Encoder Overspeed	The overspeed from the external encoder occurred.	Gr.1	Available
A.8A6*	Encoder Overheated	The overheat from the external encoder occurred.	Gr.1	Available
A.b31	Current Detection Error1 (Phase-U)	The current detection circuit for phase-U is faulty.	Gr.1	N/A
A.b32	Current Detection Error 2 (Phase-V)	The current detection circuit for phase-V is faulty.	Gr.1	N/A
A.b33	Current Detection Error 3 (Current detector)	The detection circuit for the current is faulty.	Gr.1	N/A
A.bF0	System Alarm 0	"Internal program error 0" occurred in the SERVOPACK.	Gr.1	N/A
A.bF1	System Alarm 1	"Internal program error 1" occurred in the SERVOPACK.	Gr.1	N/A
A.bF2	System Alarm 2	"Internal program error 2" occurred in the SERVOPACK.	Gr.1	N/A
A.bF3	System Alarm 3	"Internal program error 3" occurred in the SERVOPACK.	Gr.1	N/A
A.bF4	System Alarm 4	"Internal program error 4" occurred in the SERVOPACK.	Gr.1	N/A
A.C10	Servo Overrun Detected	The servomotor ran out of control.	Gr.1	Available

(cont'd)

Alarm Display	Alarm Name	Meaning	Servomotor Stop Method	Alarm Reset
A.C80	Absolute Encoder Clear Error and Multi-turn Limit Setting Error	The multi-turn for the absolute encoder was not properly cleared or set.	Gr.1	N/A
A.C90	Encoder Communications Error	Communications between the SERVOPACK and the encoder is not possible.	Gr.1	N/A
A.C91	Encoder Communications Position Data Error	An encoder position data calculation error occurred.	Gr.1	N/A
A.C92	Encoder Communications Timer Error	An error occurs in the communications timer between the encoder and the SERVOPACK.	Gr.1	N/A
A.CA0	Encoder Parameter Error	Encoder parameters are faulty.	Gr.1	N/A
A.Cb0	Encoder Echoback Error	Contents of communications with encoder is incorrect.	Gr.1	N/A
A.CC0	Multi-turn Limit Disagreement	Different multi-turn limits have been set in the encoder and the SERVOPACK.	Gr.1	N/A
A.CF1*	Feedback Option Module Communications Error (Reception error)	Reception from the feedback option module is faulty.	Gr.1	N/A
A.CF2*	Feedback Option Module Communications Error (Timer stop)	Timer for communications with the feedback option module is faulty.	Gr.1	N/A
A.d00	Position Error Pulse Overflow	Position error pulses exceeded the value set for parameter (Pn520) (Excessive Position Error Alarm Level).	Gr.1	Available
A.d01	Position Error Pulse Overflow Alarm at Servo ON	Position error pulses accumulated too much.	Gr.1	Available
A.d02	Position Error Pulse Overflow Alarm by Speed Limit at Servo ON	After a position error pulse has been input, Pn529 limits the speed if the servo ON command is received. If Pn529 limits the speed in such a state, this alarm occurs when the position references are input and the number of position error pulses exceeds the value set for parameter Pn520 (Excessive Position Error Alarm Level).	Gr.2	Available
A.d10*	Motor-load Position Error Pulse Overflow	Position error between motor and load is excessive when fully-closed position control is used.	Gr.2	Available
A.E00	Command Option Module IF Initialization Timeout Error	Communications initialization failed between the SERVOPACK and the command option module.	Gr.2	Available
A.E02	Command Option Module IF Synchronization Error 1	A synchronization error occurred between the SERVOPACK and the command option module.	Gr.1	Available
A.E03	Command Option Module IF Communications Data Error	An error occurred in the data of communications between the SERVOPACK and the command option module.	Gr.1	Available
A.E40	Command Option Module IF Communications Setting Error	An error occurred in establishing communications (settings) between the SERVOPACK and the command option module.	Gr.2	Available
A.E50	Command Option Module IF Synchronization Error 2	A error occurred in synchronization between the SERVOPACK and the command option module.	Gr.2	Available
A.E51	Command Option Module IF Synchronization Establishment Error	A error occurred in establishing communications between the SERVOPACK and the command option module.	Gr.2	Available
A.E60	Command Option Module IF Data Communications Error	A error occurred in communications between the SERVOPACK and the command option module.	Gr.2	Available
A.E61	Command Option Module IF Synchronization Error 3	There was a change in timing of synchronization between the SERVOPACK and the command option module.	Gr.2	Available
A.E70	Command Option Module Detection Failure	Detection of the command option module failed.	Gr.1	N/A
A.E71	Safety Option Module Detection Failure	Detection of the safety option module failed.	Gr.1	N/A
A.E72*	Feedback Option Module Detection Failure	Detection of the feedback option module failed.	Gr.1	N/A

(cont'd)

Alarm Display	Alarm Name	Meaning	Servomotor Stop Method	Alarm Reset
A.E73	Unsupported Command Option Module	An unsupported command option module was connected.	Gr.1	N/A
A.E74	Unsupported Safety Option Module	An unsupported safety option module was connected.	Gr.1	N/A
A.E75*	Unsupported Feedback Option Module	An unsupported feedback option module was connected.	Gr.1	N/A
A.E80	Command Option Module Unmatched Error	The command option module was replaced with a different model.	Gr.1	N/A
A.EA2	DRV Alarm 2 (SERVOPACK WDC error)	A DRV 0 error of the SERVOPACK occurred.	Gr.2	Available
A.Eb1	Safety Device Signal Input Timing Error	There is an error in the timing of the safety function input signal.	Gr.1	N/A
A.ED1	Command Option Module IF Command Timeout Error	Processing of reference from the command option module was not completed.	Gr.2	Available
A.F10	Main Circuit Cable Open Phase	With the main power supply ON, voltage was low for more than 1 second in phase-R, -S or -T.	Gr.2	Available
CPF00	Digital Operator Transmission Error 1	Digital operator (JUSP-OP05A) fails to communicate with the SERVOPACK (e.g., CPU error).	–	N/A
CPF01	Digital Operator Transmission Error 2		–	N/A
A.--	Not an error	Normal operation status	–	–

* This alarm may occur when a fully-closed option module is mounted.

9.1.2 Troubleshooting of Alarms

When an error occurs in SERVOPACKs, an alarm is displayed such as A.□□□ and CPF□□ on the panel operator. Refer to the following table to identify the cause of an alarm and the action to be taken.

Contact your Yaskawa representative if the problem cannot be solved by the described corrective action.

Alarm: Alarm Name	Cause	Investigative Actions	Corrective Actions
A.020: Parameter Checksum Error (The parameter data in the SERVOPACK is incorrect.)	The power supply voltage suddenly dropped.	Measure the power supply voltage.	Set the power supply voltage within the specified range, and initialize the parameter (Fn005).
	The power supply went OFF while changing a parameter setting.	Note the circumstances when the power supply went OFF.	Initialize the parameter (Fn005) and then set the parameter again.
	The number of times that parameters were written exceeded the limit.	Were the parameters frequently changed through the host controller?	The SERVOPACK may be faulty. Repair or replace the SERVOPACK. Reconsider the method of writing parameters.
	Malfunction caused by noise from the AC power supply or grounding line, static electricity noise, etc.	Turn the power supply ON and OFF several times. If the alarm still occurs, there may be noise interference.	Take countermeasures against noise.
	Gas, water drops, or cutting oil entered the SERVOPACK and caused failure of the internal components.	Check the installation conditions.	The SERVOPACK may be faulty. Replace the SERVOPACK.
	A SERVOPACK fault occurred.	Turn the power supply ON and OFF several times. If the alarm still occurs, the SERVOPACK is faulty.	The SERVOPACK may be faulty. Replace the SERVOPACK.
A.021: Parameter Format Error (The parameter data format in the SERVOPACK is incorrect.)	The software version of SERVOPACK that caused the alarm is older than that of the written parameter.	Check Fn012 to see if the set software version agrees with that of the SERVOPACK. If not, an alarm may occur.	Write the parameter of another SERVOPACK of the same model with the same software version. Then turn the power OFF and then ON again.
	A SERVOPACK fault occurred.	—	The SERVOPACK may be faulty. Replace the SERVOPACK.
A.022: System Checksum Error (The parameter data in the SERVOPACK is incorrect.)	The power supply voltage suddenly dropped.	Measure the power supply voltage.	The SERVOPACK may be faulty. Replace the SERVOPACK.
	The power supply went OFF while setting an utility function.	Note the circumstances when the power supply went OFF.	The SERVOPACK may be faulty. Replace the SERVOPACK.
	A SERVOPACK fault occurred.	Turn the power supply ON and OFF several times. If the alarm still occurs, the SERVOPACK is faulty.	The SERVOPACK may be faulty. Replace the SERVOPACK.
A.030: Main Circuit Detector Error	A SERVOPACK fault occurred.	—	The SERVOPACK may be faulty. Replace the SERVOPACK.
A.040: Parameter Setting Error (The parameter setting was out of the allowable setting range.)	The SERVOPACK and servomotor capacities do not match each other.	Check the combination of SERVOPACK and servomotor capacities.	Select the proper combination of SERVOPACK and servomotor capacities.
	A SERVOPACK fault occurred.	—	The SERVOPACK may be faulty. Replace the SERVOPACK.
	The parameter setting is out of the specified range.	Check the setting ranges of the parameters that have been changed.	Set the parameter to a value within the specified range.
	The electronics gear ratio is out of the setting range.	Check the electronic gear ratio. The ratio must satisfy: $0.001 < (Pn20E/Pn210) < 4000$.	Set the electronic gear ratio in the range: $0.001 < (Pn20E/Pn210) < 4000$.
A.041: Encoder Output Pulse Setting Error	The encoder output pulse (Pn212) is out of the setting range and does not satisfy the setting conditions.	Check the parameter Pn212.	Set Pn212 to a correct value.

(cont'd)

Alarm: Alarm Name	Cause	Investigative Actions	Corrective Actions
A.042: Parameter Combination Error	The speed of program JOG operation (Fn004) is lower than the setting range after having changed the electronic gear ratio (Pn20E/Pn210) or the servomotor.	Check that the detection conditions *1 is satisfied.	Reduce the electronic gear ratio (Pn20E/Pn210).
	The speed of program JOG operation (Fn004) is lower than the setting range after having changed the setting of Pn533 "Program JOG Movement Speed."	Check that the detection conditions *1 is satisfied.	Increase the setting for Pn533 "Program JOG Movement Speed."
	The moving speed during advanced autotuning is lower than the setting range after having changed the electronic gear ratio (Pn20E/Pn210) or the servomotor.	Check that the detection conditions *1 is satisfied.	Reduce the electronic gear ratio (Pn20E/Pn210).
A.044: Fully-closed Loop Control Parameter Setting Error	The setting of the option module does not match with that of Pn002.3.	Check the settings of Pn002.3.	The setting of option module must be compatible with the settings of Pn002.3.
A.04A: Parameter Setting Error 2	A parameter reserved by the system was changed.	–	Set the following reserved parameters to the factory settings. Pn200.2 Pn207.1 Pn50A.0 Pn50A.1 Pn50A.2 Pn50C Pn50D
A.050: Combination Error (The SERVOPACK and servomotor capacities do not correspond.)	The SERVOPACK and servomotor capacities do not match each other.	Check the capacities if they satisfy the following equation: $1/4 \leq (\text{Servomotor capacity})/(\text{SERVOPACK capacity}) \leq 4$.	Select the proper combination of SERVOPACK and servomotor capacities.
	An encoder fault occurred.	Replace the servomotor and see if the alarm occurs again.	Replace the servomotor (encoder).
	A SERVOPACK fault occurred.	–	The SERVOPACK may be faulty. Replace the SERVOPACK.

$$*1. \quad \text{Pn533} [\text{min}^{-1}] \times \frac{2 (\text{encoder resolution})}{6 \times 10^5} \leq \frac{\text{Pn20E}}{\text{Pn210}}$$

(cont'd)

Alarm: Alarm Name	Cause	Investigative Actions	Corrective Actions
A.051: Unsupported Device Alarm	An unsupported serial converter unit, serial encoder, or external encoder is connected to the SERVOPACK.	Check the product specifications.	Select the correct combination of units.
A.0b0: Cancelled Servo ON Command Alarm	After executing the utility function to turn ON the power to the motor, the Servo ON command was sent from the host controller.	—	Turn the SERVOPACK power supply OFF and then ON again or perform a software reset.
A.100: Overcurrent or Heat Sink Overheated (An overcurrent flowed through the IGBT or heat sink of SERVOPACK overheated.)	Incorrect wiring or contact fault of main circuit cable or motor main circuit cable.	Check the wiring. Refer to 3.1 <i>Main Circuit Wiring</i> .	Correct the wiring.
	Short-circuit or ground fault of main circuit cable or motor main circuit cable.	Check for short-circuits across the servomotor terminal phase-U, -V, and -W, or between the grounding and servomotor terminal U, V, or W. Refer to 3.1 <i>Main Circuit Wiring</i> .	Some cables may be damaged. Replace damaged cables.
	Short-circuit or ground fault inside the servomotor.	Check for short-circuits across the servomotor terminal phase-U, -V, and -W, or between the grounding and servomotor terminal U, V, or W. Refer to 3.1 <i>Main Circuit Wiring</i> .	The servomotor may be faulty. Replace the servomotor.
	Short-circuit or ground fault inside the SERVOPACK.	Check for short-circuits across the servomotor connection terminals U, V, and W on the SERVOPACK, or between the grounding and terminal U, V, or W. Refer to 3.1 <i>Main Circuit Wiring</i> .	The SERVOPACK may be faulty. Replace the SERVOPACK.
	Incorrect wiring or contact fault of the regenerative resistor.	Check the wiring. Refer to 3.7 <i>Regenerative Resistors Connections</i> .	Correct the wiring.
	The dynamic brake (DB: Emergency stop executed from the SERVOPACK) was frequently activated, or the DB overload alarm occurred.	Check the resistor power consumption monitor Un00B to see how many times the DB has been used. Or, check the alarm trace back monitor Fn000 to see if the DB overload alarm A.730 or A.731 was reported.	Change the SERVOPACK model, operation conditions, or the mechanism so that the DB does not need to be used so frequently.
	The generated regenerative energy exceeded the SERVOPACK regenerative energy processing capacity.	Check the regenerative load ratio monitor Un00A to see how many times the regenerative resistor has been used.	Check the operation condition including overload, and reconsider the regenerative resistor value.
	The SERVOPACK regenerative resistance is too small.	Check the regenerative load ratio monitor Un00A to see how many times the regenerative resistor has been used.	Change the regenerative resistance value to a value larger than the SERVOPACK minimum allowable resistance value.
	A heavy load was applied while the servomotor was stopped or running at low-speed.	Check to see if the operating conditions are outside servo drive specifications.	Reduce the load applied to the servomotor or increase the operation speed.
	Malfunction caused by noise interference.	Improve the wiring or installation environment, such as by reducing noise, and check to see if the alarm recurs.	Take countermeasures for noise, such as correct wiring of the FG. Use an FG wire size equivalent to the SERVOPACK main circuit wire size.
A SERVOPACK fault occurred.	—	Turn the power supply OFF and then ON again. If the alarm still occurs, the SERVOPACK may be faulty. Replace the SERVOPACK.	

(cont'd)

Alarm: Alarm Name	Cause	Investigative Actions	Corrective Actions
A.300: Regeneration Error	Regenerative resistor capacity (Pn600) is set to a value other than 0 for a SGDVR70, -R90, -1R6, or -2R8 SERVO-PACK, and an external regenerative resistor is not connected.	Check the external regenerative resistor connection and the value of the Pn600.	Connect the external regenerative resistor, or set Pn600 to 0 if no regenerative resistor is required.
	The jumper between the power supply terminals B2 and B3 is removed.	Confirm that a jumper is mounted between the power supply terminals B2 and B3.	Correctly mount a jumper.
	The external regenerative resistor is incorrectly wired, or is removed or disconnected.	Check the external regenerative resistor connection.	Correctly connect the external regenerative resistor.
	A SERVOPACK fault occurred.	–	While the main circuit power supply is OFF, turn the control power supply OFF and then turn ON again. If the alarm still occurs, the SERVOPACK may be faulty. Replace the SERVOPACK.
A.320: Regenerative Overload	The power supply voltage exceeds the specified limit.	Measure the power supply voltage.	Set the power supply voltage within the specified range.
	Incorrect external regenerative resistance. Insufficient SERVOPACK capacity or regenerative resistor capacity. Or, regenerative power has been continuously flowing back.	Check the operation condition or the capacity using the capacity selection Software SigmaJunmaSize+, etc.	Change the regenerative resistance, regenerative resistor capacity, or SERVOPACK capacity. Reconsider the operation conditions using the capacity selection software SigmaJunmaSize+, etc.
	Regenerative power continuously flowed back because negative load was continuously applied.	Check the load to the servomotor during operation.	Reconsider the system including servo, machine, and operation conditions.
	The setting of parameter Pn600 is smaller than the external regenerative resistor's capacity.	Check the external regenerative resistor connection and the value of the Pn600.	Set the Pn600 to a correct value.
	The external regenerative resistance is too high.	Check the regenerative resistance.	Change the regenerative resistance to a correct value or use an external regenerative resistor of appropriate capacity.
	A SERVOPACK fault occurred.	–	The SERVOPACK may be faulty. Replace the SERVOPACK.
	A.330: Main Circuit Power Supply Wiring Error (Detected when the power to the main circuit is turned ON.)	The regenerative resistor disconnected when the SERVOPACK power voltage was increased.	Measure the resistance of the regenerative resistor.
In the AC power input mode, DC power was supplied.		Check the power supply to see if it is a DC power supply.	Correct the settings to match the actual power supply specifications.
In the DC power input mode, AC power was supplied.		Check the power supply to see if it is a AC power supply.	Correct the settings to match the actual power supply specifications.
Regenerative resistor capacity (Pn600) is not set to 0 even though the regenerative resistor is disconnected.		Is the regenerative resistor connected? If it is, check the regenerative resistor capacity.	Set Pn600 to 0.
A SERVOPACK fault occurred.		–	The SERVOPACK may be faulty. Replace the SERVOPACK.

(cont'd)

Alarm: Alarm Name	Cause	Investigative Actions	Corrective Actions
A.400: Overvoltage (Detected in the SERVOPACK's main circuit power supply section.)	<ul style="list-style-type: none"> • For 100 VAC SERVOPACKs: The AC power supply voltage exceeded 145 V. • For 200 VAC SERVOPACKs: The AC power supply voltage exceeded 290 V. • For 400 VAC SERVOPACKs: The AC power supply voltage exceeded 580 V. • For 200 VAC SERVOPACKs with DC power supply input: The power supply voltage exceeded 410 V. • For 400 VAC SERVOPACKs with DC power supply input: The power supply voltage exceeded 820 V. 	Measure the power supply voltage.	Set AC/DC power supply voltage within the specified range.
	The power supply is unstable, or was influenced by a lightning surge.	Measure the power supply voltage.	Improve the power supply conditions by installing a surge absorber, etc. Then, turn the power supply ON again. If the alarm still occurs, the SERVOPACK may be faulty. Replace the SERVOPACK.
	Acceleration/deceleration was executed under the following conditions. <ul style="list-style-type: none"> • The AC power supply voltage of 100 VAC SERVOPACK was in the range between 115 V and 135 V. • The AC power supply voltage of 200 VAC SERVOPACK was in the range between 230 V and 270 V. • The AC power supply voltage of 400 VAC SERVOPACK was in the range between 480 V and 560 V. 	Check the power supply voltage and the speed and torque during operation.	Set AC power supply voltage within the specified range.
	The external regenerative resistance is too high for the actual operation conditions.	Check the operation conditions and the regenerative resistance.	Select a regenerative resistance value appropriate for the operation conditions and load.
	The moment of inertia exceeded the allowable value.	Confirm that the moment of inertia ratio is within the allowable range.	Increase the deceleration time, or reduce the load.
	A SERVOPACK fault occurred.	—	Turn the control power OFF and then ON again while the main circuit power supply is OFF. If the alarm still occurs, the SERVOPACK may be faulty. Replace the SERVOPACK.

(cont'd)

Alarm: Alarm Name	Cause	Investigative Actions	Corrective Actions
A.410: Undervoltage (Detected in the SERVOPACK main circuit power supply section.)	<ul style="list-style-type: none"> For 100 VAC SERVOPACKs: The power supply voltage is 49 V or less. For 200 VAC SERVOPACKs: The power supply voltage is 120 V or less. For 400 VAC SERVOPACKs: The power supply voltage is 240 V or less. 	Measure the power supply voltage.	Set the power supply voltage within the specified range.
	The power supply voltage dropped during operation.	Measure the power supply voltage.	Increase the power supply capacity.
	Occurrence of instantaneous power interruption.	Measure the power supply voltage.	When the instantaneous power cut hold time Pn509 is set, decrease the setting.
	The SERVOPACK fuse is blown out.	–	Replace the SERVOPACK, connect an AC/DC reactor, and run the SERVOPACK.
	A SERVOPACK fault occurred.	–	The SERVOPACK may be faulty. Replace the SERVOPACK.
A.450: Main-Circuit Capacitor Overvoltage	A SERVOPACK fault occurred.	–	Replace the SERVOPACK.
A.510: Overspeed (The servomotor speed exceeds the maximum.)	The order of phases U, V, and W in the servomotor wiring is incorrect.	Check the servomotor wiring.	Confirm that the servomotor is correctly wired.
	A reference value exceeding the overspeed detection level was input.	Check the input value.	Reduce the reference value or adjust the gain.
	The motor speed exceeded the maximum.	Check the servomotor speed waveform.	Reduce the speed reference input gain, adjust the servo gain, or reconsider the operation conditions.
	A SERVOPACK fault occurred.	–	The SERVOPACK may be faulty. Replace the SERVOPACK.
A.511: Overspeed of Encoder Output Pulse Rate	The encoder output pulse output frequency exceeded the limit.	Check the encoder output pulse output setting.	Decrease the setting of the encoder output pulse (Pn212).
	The encoder output pulse output frequency exceeded the limit because the servomotor speed was too high.	Check the encoder output pulse output setting and servomotor speed.	Decrease the servomotor speed.
A.520: Vibration Alarm	Abnormal vibration was detected at the servomotor rotation speed.	Check for abnormal noise from the servomotor, and check the speed and torque waveform during operation.	Reduce the servomotor speed or reduce the speed loop gain (Pn100).
	The moment of inertia ratio (Pn103) value is greater than the actual value or is greatly changed.	Check the moment of inertia ratio.	Set the moment of inertia ratio (Pn103) to an appropriate value.
A.521: Autotuning Alarm (Vibration was detected while executing the advanced autotuning, one-parameter tuning, EasyFFT, or tuning-less function.)	The servomotor vibrated considerably while performing tuning-less function (factory setting).	Check the servomotor speed waveform.	Reduce the load so that the moment of inertia ratio falls within the allowable value, or raise the tuning level or reduce the gain level using the tuning-less function (Fn200).
	The servomotor vibrated considerably during advanced autotuning, one-parameter tuning, or EasyFFT.	Check the servomotor speed waveform.	Check the operation procedure of corresponding function and take a corrective action.

(cont'd)

Alarm: Alarm Name	Cause	Investigative Actions	Corrective Actions
A.710: A.720: Overload A.710: High Load A.720: Low Load	Incorrect wiring or contact fault of servomotor and encoder.	Check the wiring.	Confirm that the servomotor and encoder are correctly wired.
	Operation beyond the overload protection characteristics.	Check the servomotor overload characteristics and executed run command.	Reconsider the load conditions and operation conditions. Or, increase the servomotor capacity.
	Excessive load was applied during operation because the servomotor was not driven due to mechanical problems.	Check the executed run command and servomotor speed.	Remove the mechanical problems.
	A SERVOPACK fault occurred.	–	The SERVOPACK may be faulty. Replace the SERVOPACK.
A.730: A.731: Dynamic Brake Overload (An excessive power consumption of dynamic brake was detected.)	The servomotor rotates because of external force.	Check the operation status.	Take measures to ensure the servomotor will not rotate because of external force.
	The rotating energy at a DB stop exceeds the DB resistance capacity.	Check the DB resistor power consumption monitor (Un00B) to see how many times the DB has been used.	<ul style="list-style-type: none"> • Reduce the servomotor reference speed. • Reduce the moment of inertia ratio. • Reduce the number of times of the DB stop operation.
	A SERVOPACK fault occurred.	–	The SERVOPACK may be faulty. Replace the SERVOPACK.
A.740: Overload of Surge Current Limit Resistor (The main circuit power is turned ON/OFF too frequently.)	The inrush current limit resistor operation frequency at the main circuit power supply ON/OFF operation exceeds the allowable range.	–	Reduce the frequency of turning the main circuit power supply ON/OFF.
	A SERVOPACK fault occurred.	–	The SERVOPACK may be faulty. Replace the SERVOPACK.
A.7A0: Heat Sink Overheated (Detected when the heat sink temperature exceeds 100°C.)	The surrounding air temperature is too high.	Check the surrounding air temperature using a thermostat.	Decrease the surrounding air temperature by improving the SERVOPACK installation conditions.
	The overload alarm has been reset by turning OFF the power too many times.	Check the alarm trace back monitor (Fn000) to see if the overload alarm was reported.	Change the method for resetting the alarm.
	Excessive load or operation beyond the regenerative energy processing capacity.	Check the accumulated load ratio monitor Un009 to see the load during operation, and the regenerative load ratio monitor Un00A to see the regenerative energy processing capacity.	Reconsider the load and operation conditions.
	Incorrect SERVOPACK installation orientation or/and insufficient space around the SERVOPACK.	Check the SERVOPACK installation conditions.	Install the SERVOPACK correctly as specified.
	A SERVOPACK fault occurred.	–	The SERVOPACK may be faulty. Replace the SERVOPACK.
A.7AB: Built-in Fan in SERVOPACK Stopped	The fan inside the SERVOPACK stopped.	Check for foreign matter or debris inside the SERVOPACK.	Remove foreign matter or debris from the SERVOPACK. If the alarm still occurs, the SERVOPACK may be faulty. Replace the SERVOPACK.

(cont'd)

Alarm: Alarm Name	Cause	Investigative Actions	Corrective Actions
A.810: Encoder Backup Error (Detected on the encoder side) (Only when an absolute encoder is connected.)	Alarm occurred when the power to the absolute encoder was initially turned ON.	Check to see if the power was turned ON initially.	Set up the encoder (Fn008).
	The encoder cable was disconnected, and was connected again.	Check to see if the power was turned ON initially.	Confirm the connection and set up the encoder (Fn008).
	The power from both the control power supply (+5 V) and the battery power supply from the SERVOPACK is not being supplied.	Check the encoder connector battery or the connector contact status.	Replace the battery or take similar measures to supply power to the encoder, and set up the encoder (Fn008).
	An absolute encoder fault occurred.	—	If the alarm cannot be reset by setting up the encoder again, replace the servomotor.
	A SERVOPACK fault occurred.	—	The SERVOPACK may be faulty. Replace the SERVOPACK.
A.820: Encoder Checksum Error (Detected on the encoder side.)	An encoder fault occurred.	—	Set up the encoder again using Fn008. If the alarm still occurs, the servomotor may be faulty. Replace the servomotor.
	A SERVOPACK fault occurred.	—	The SERVOPACK may be faulty. Replace the SERVOPACK.
A.830: Absolute Encoder Battery Error (The absolute encoder battery voltage is lower than the specified value.)	The battery connection is incorrect.	Check the battery connection.	Reconnect the battery.
	The battery voltage is lower than the specified value 2.7 V.	Measure the battery voltage.	Replace the battery.
	A SERVOPACK fault occurred.	—	The SERVOPACK may be faulty. Replace the SERVOPACK.
A.840: Encoder Data Error (Detected on the encoder side.)	An encoder fault occurred.	—	Turn the power supply OFF and then ON again. If the alarm still occurs, the servomotor may be faulty. Replace the servomotor.
	Malfunction of encoder because of noise interference, etc.	—	Correct the wiring around the encoder by separating the encoder cable from the servomotor main circuit cable or by checking the grounding and other wiring.
A.850: Encoder Overspeed (Detected when the control power supply was turned ON.) (Detected on the encoder side.)	The servomotor was running at 200 min ⁻¹ or higher when the control power supply was turned ON.	Check the speed monitor (Un000) to confirm the servomotor speed when the power is turned ON.	Reduce the servomotor speed to a value less than 200 min ⁻¹ , and turn ON the control power supply.
	An encoder fault occurred.	—	Turn the power supply OFF and then ON again. If the alarm still occurs, the servomotor may be faulty. Replace the servomotor.
	A SERVOPACK fault occurred.	—	Turn the power supply OFF and then ON again. If the alarm still occurs, the SERVOPACK may be faulty. Replace the SERVOPACK.

(cont'd)

Alarm: Alarm Name	Cause	Investigative Actions	Corrective Actions
A.860: Encoder Overheated (Only when an absolute encoder is connected.) (Detected on the encoder side.)	The ambient operating temperature around the servomotor is too high.	Measure the ambient operating temperature around the servomotor.	The ambient operating temperature of the servomotor must be 40°C or less.
	The servomotor load is greater than the rated load.	Check the accumulated load ratio monitor (Un009) to see the load.	The servomotor load must be within the specified range.
	An encoder fault occurred.	—	Turn the power supply OFF and then ON again. If the alarm still occurs, the servomotor may be faulty. Replace the servomotor.
	A SERVOPACK fault occurred.	—	Turn the power supply OFF and then ON again. If the alarm still occurs, the SERVOPACK may be faulty. Replace the SERVOPACK.
A.8A0*2: External Encoder Error of Scale	Setting of the zero point position of absolute external encoder failed because the servomotor rotated.	Before setting the zero point position, use the fully-closed feedback counter monitor (Un00E) to confirm that the servomotor is not rotating.	The servomotor must be stopped while setting the zero point position.
	An external encoder fault occurred.	—	Replace the external encoder.
A.8A1*2: External Encoder Error of Module	An external encoder fault occurred.	—	Replace the external encoder.
	A serial converter unit fault occurred.	—	Replace the serial converter unit.
A.8A2*2: External Encoder Error of Sensor (Incremental)	An external encoder fault occurred.	—	Replace the external encoder.
A.8A3*2: External Encoder Error of Position (Absolute)	An absolute external encoder fault occurred.	—	The absolute external encoder may be faulty. Refer to the encoder manufacturer's instruction manual for corrective actions.
A.8A5*2: Encoder Overspeed	The overspeed from the external encoder occurred.	—	Replace the external encoder.
A.8A6*2: Encoder Overheated	The overheat from the external encoder occurred.	—	Replace the external encoder.
A.b31: Current Detection Error 1 (Phase-U)	The current detection circuit for phase U is faulty.	—	Turn the power supply OFF and then ON again. If the alarm still occurs, the SERVOPACK may be faulty. Replace the SERVOPACK.
A.b32: Current Detection Error 2 (Phase-V)	The current detection circuit for phase V is faulty.	—	Turn the power supply OFF and then ON again. If the alarm still occurs, the SERVOPACK may be faulty. Replace the SERVOPACK.
A.b33: Current Detection Error 3 (Current detector)	The detection circuit for the current is faulty.	—	Turn the power supply OFF and then ON again. If the alarm still occurs, the SERVOPACK may be faulty. Replace the SERVOPACK.
	The servomotor main circuit cable is disconnected.	Check for disconnection of the motor main circuit cable.	Correct the servomotor wiring.
A.bF0: System Alarm 0	A SERVOPACK fault occurred.	—	Turn the power supply OFF and then ON again. If the alarm still occurs, the SERVOPACK may be faulty. Replace the SERVOPACK.

*2. This alarm may occur when a fully-closed option module is mounted.

(cont'd)

Alarm: Alarm Name	Cause	Investigative Actions	Corrective Actions
A.bF1: System Alarm 1	A SERVOPACK fault occurred.	—	Turn the power supply OFF and then ON again. If the alarm still occurs, the SERVOPACK may be faulty. Replace the SERVOPACK.
A.bF2: System Alarm 2	A SERVOPACK fault occurred.	—	Turn the power supply OFF and then ON again. If the alarm still occurs, the SERVOPACK may be faulty. Replace the SERVOPACK.
A.bF3: System Alarm 3	A SERVOPACK fault occurred.	—	Turn the power supply OFF and then ON again. If the alarm still occurs, the SERVOPACK may be faulty. Replace the SERVOPACK.
A.bF4: System Alarm 4	A SERVOPACK fault occurred.	—	Turn the power supply OFF and then ON again. If the alarm still occurs, the SERVOPACK may be faulty. Replace the SERVOPACK.
A.C10: Servo Overrun Detected (Detected when the servomotor power is ON.)	The order of phases U, V, and W in the servomotor wiring is incorrect.	Check the servomotor wiring.	Confirm that the servomotor is correctly wired.
	An encoder fault occurred.	—	If the alarm still occurs after turning the power OFF and then ON again, even though the servomotor is correctly wired, the servomotor may be faulty. Replace the servomotor.
	A SERVOPACK fault occurred.	—	Turn the power supply OFF and then ON again. If the alarm still occurs, the SERVOPACK may be faulty. Replace the SERVOPACK.
A.C80: Absolute Encoder Clear Error and Multi- turn Limit Setting Error	An encoder fault occurred.	—	Turn the power supply OFF and then ON again. If the alarm still occurs, the servomotor may be faulty. Replace the servomotor.
	A SERVOPACK fault occurred.	—	Turn the power supply OFF and then ON again. If the alarm still occurs, the SERVOPACK may be faulty. Replace the SERVOPACK.
A.C90: Encoder Communications Error	Contact fault of encoder connector or incorrect encoder wiring.	Check the encoder connector contact status.	Re-insert the encoder connector and confirm that the encoder is correctly wired.
	Encoder cable disconnection or short-circuit. Or, incorrect cable impedance.	Check the encoder cable.	Use the encoder cable with the specified rating.
	<ul style="list-style-type: none"> • Corrosion caused by improper temperature, humidity, or gas. • Short-circuit caused by intrusion of water drops or cutting oil. • Connector contact fault caused by vibration. 	Check the operating environment.	Improve the operating environmental conditions, and replace the cable. If the alarm still occurs, replace the SERVOPACK.
	Malfunction caused by noise interference.	—	Correct the wiring around the encoder to avoid noise interference (Separate the encoder cable from the servomotor main circuit cable, improve grounding, etc.)
	A SERVOPACK fault occurred.	—	Connect the servomotor to another SERVOPACK, and turn ON the control power. If no alarm occurs, the SERVOPACK may be faulty. Replace the SERVOPACK.

(cont'd)

Alarm: Alarm Name	Cause	Investigative Actions	Corrective Actions
A.C91: Encoder Communications Position Data Error	The noise interference occurred on the input/output signal line because the encoder cable is bent and the sheath is damaged.	Check the encoder cable and connector.	Confirm that there is no problem with the encoder cable layout.
	The encoder cable is bundled with a high-current line or near a high-current line.	Check the encoder cable layout.	Confirm that there is no surge voltage on the encoder cable.
	The FG potential varies because of influence from machines on the servomotor side, such as the welder.	Check the encoder cable layout.	Properly ground the device to separate from the encoder side FG.
A.C92: Encoder Communications Timer Error	Noise interference occurred on the input/output signal line from the encoder.	–	Take countermeasures against noise.
	Excessive vibration and shocks were applied to the encoder.	Check the operating environment.	Reduce the machine vibration or correctly install the servomotor.
	An encoder fault occurred.	–	Turn the power supply OFF and then ON again. If the alarm still occurs, the servomotor may be faulty. Replace the servomotor.
	A SERVOPACK fault occurred.	–	Turn the power supply OFF and then ON again. If the alarm still occurs, the SERVOPACK may be faulty. Replace the SERVOPACK.
A.CA0: Encoder Parameter Error	An encoder fault occurred.	–	Turn the power supply OFF and then ON again. If the alarm still occurs, the servomotor may be faulty. Replace the servomotor.
	A SERVOPACK fault occurred.	–	Turn the power supply OFF and then ON again. If the alarm still occurs, the SERVOPACK may be faulty. Replace the SERVOPACK.
A.Cb0: Encoder Echoback Error	The encoder wiring and contact are incorrect.	Check the encoder wiring.	Correct the encoder wiring.
	Noise interference occurred due to incorrect encoder cable specifications.	–	Use tinned annealed copper twisted-pair or shielded twisted-pair cable with a core of at least 0.12 mm ² .
	Noise interference occurred because the wiring distance for the encoder cable is too long.	–	The wiring distance must be 20 m max.
	The FG potential varies because of influence from machines on the servomotor side, such as the welder.	Check the encoder cable and connector.	Make the grounding for the machine separately from encoder side FG.
	Excessive vibration and shocks were applied to the encoder.	Check the operating environment.	Reduce the machine vibration or correctly install the servomotor.
	An encoder fault occurred.	–	Turn the power supply OFF and then ON again. If the alarm still occurs, the servomotor may be faulty. Replace the servomotor.
	A SERVOPACK fault occurred.	–	Turn the power supply OFF and then ON again. If the alarm still occurs, the SERVOPACK may be faulty. Replace the SERVOPACK.

(cont'd)

Alarm: Alarm Name	Cause	Investigative Actions	Corrective Actions
A.CC0: Multi-turn Limit Disagreement	When using a direct-drive (DD) servomotor, the multi-turn limit value (Pn205) is different from that of the encoder.	Check the value of the Pn205.	Correct the setting of Pn205 (0 to 65535).
	The multi-turn limit value of the encoder is different from that of the SERVOPACK. Or, the multi-turn limit value of the SERVOPACK has been changed.	Check the value of the Pn205 of the SERVOPACK.	Execute Fn013 at the occurrence of alarm.
	A SERVOPACK fault occurred.	—	Turn the power supply OFF and then ON again. If the alarm still occurs, the SERVOPACK may be faulty. Replace the SERVOPACK.
A.CF1*2: Feedback Option Module Communications Error (Reception error)	Wiring of cable between serial converter unit and SERVOPACK is incorrect or contact is faulty.	Check the external encoder wiring.	Correct the cable wiring.
	The specified cable is not used between serial converter unit and SERVOPACK.	Confirm the external encoder wiring specifications.	Use the specified cable.
	Cable between serial converter unit and SERVOPACK is too long.	Measure the external encoder cable length.	Use 20 m cable max.
	Sheath of cable between serial converter unit and SERVOPACK is broken.	Check the external encoder cable.	Replace the cable.
A.CF2*2: Feedback Option Module Communications Error (Timer stop)	Noise interferes with the cable between serial converter unit and SERVOPACK.	—	Correct the wiring around serial converter unit, e.g., separating input/output signal line from main circuit cable or grounding.
	A serial converter unit fault occurred.	—	Replace the serial converter unit.
	A SERVOPACK fault occurred.	—	Replace the SERVOPACK.
A.d00: Position Error Pulse Overflow (Position error exceeded the value set in the excessive position error alarm level (Pn520))	The contact in the servomotor U, V, and W wirings is faulty.	Check the motor main circuit cable connection.	Confirm that there is no contact fault in the motor wiring of encoder wiring.
	The frequency of the position reference is too high.	Reduce the reference frequency, and operate the SERVOPACK.	Reduce the position reference frequency or reference acceleration. Or, reconsider the electronic gear ratio.
	The position reference acceleration is too fast.	Reduce the reference acceleration, and operate the SERVOPACK.	Apply the smoothing function, such as using position reference acceleration/deceleration time constant (Pn216).
	Setting of the Pn520 (Excessive Position Error Alarm Level) is low against the operating condition.	Check the alarm level (Pn520) to see if it is set to an appropriate value.	Set the Pn520 to proper value.
	A SERVOPACK fault occurred.	—	Turn the power supply OFF and then ON again. If the alarm still occurs, the SERVOPACK may be faulty. Replace the SERVOPACK.
A.d01: Position Error Pulse Overflow Alarm at Servo ON	The servo ON command is received when the number of position error pulses is greater than the set value of Pn526.	Check the error counter monitor (Un008) while the servomotor power is OFF.	Make the setting so that the position error pulse is cleared when the servo is OFF. Or, correct the excessive position error alarm level at servo ON (Pn526).

*2. This alarm may occur when a fully-closed option module is mounted.

(cont'd)

Alarm: Alarm Name	Cause	Investigative Actions	Corrective Actions
A.d02: Position Error Pulse Overflow Alarm by Speed Limit at Servo ON	After a position error pulse has been input, Pn529 limits the speed if the servo ON command is received. If Pn529 limits the speed in such a state, this alarm occurs when the position references are input and the number of position error pulses exceeds the value set for parameter Pn520 (Excessive Position Error Alarm Level).	–	Make the setting so that the position error pulse is cleared when the servo is OFF. Or, correct the excessive position error alarm level (Pn520). Or, adjust the speed limit level (Pn529) when servo turns ON.
A.d10*2: Motor-load Position Error Pulse Overflow	Motor rotation direction and external encoder installation direction are opposite.	Check the servomotor rotation direction and the external encoder installation direction.	Install the external encoder in the opposite direction, or reverse the setting of the external encoder usage method (Pn002.3).
	Mounting of the load (e.g., stage) and external encoder joint installation are incorrect.	Check the external encoder mechanical connection.	Check the mechanical joints.
A.E00: Command Option Module IF Initialization Timeout Error	The connection between the SERVOPACK and the command option module is faulty.	Check the connection between the SERVOPACK and the command option module.	Correctly connect the command option module.
	A command option module fault occurred.	–	Replace the command option module.
	A SERVOPACK fault occurred.	–	Replace the SERVOPACK.
A.E02: Command Option Module IF Synchronization Error 1	The timing of synchronization between the servomotor and command option module changed due to change in the communications cycle of the host controller connected to the command option module.	–	Turn the power supply OFF and then ON again. If the alarm occurs again, restart communications processing from the host controller.
	The connection between the SERVOPACK and the command option module is faulty.	Check the connection between the SERVOPACK and the command option module.	Correctly connect the command option module.
	A command option module fault occurred.	–	Replace the command option module.
	A SERVOPACK fault occurred.	–	Replace the SERVOPACK.
A.E03: Command Option Module IF Communications Data Error	An error occurred due to noise in the communications between the SERVOPACK and the command option module.	–	Take measures against noise.
	The connection between the SERVOPACK and the command option module is faulty.	Check the connection between the SERVOPACK and the command option module.	Correctly connect the command option module.
	A command option module fault occurred.	–	Replace the command option module.
	A SERVOPACK fault occurred.	–	Replace the SERVOPACK.
A.E40: Command Option Module IF Communications Setting Error	A command option module fault occurred.	–	Replace the command option module.

*2. The alarm may occur when a fully-closed option module is mounted.

(cont'd)

Alarm: Alarm Name	Cause	Investigative Actions	Corrective Actions
A.E50: Command Option Module IF Synchronization Error 2	The timing of synchronization between the servomotor and command option module changed due to change in the communications cycle of the host controller connected to the command option module.	—	Turn the power supply OFF and then ON again. If the alarm occurs again, restart communications processing from the host controller.
A.E51: Command Option Module IF Synchronization Establishment Error	A command option module fault occurred.	—	Replace the command option module.
A.E60: Command Option Module IF Data Communications Error	An error occurred due to noise in the communications between the SERVOPACK and the command option module.	—	Take measures against noise.
	The connection between the SERVOPACK and the command option module is faulty.	Check the connection between the SERVOPACK and the command option module.	Correctly connect the command option module.
	A command option module fault occurred.	—	Replace the command option module.
	A SERVOPACK fault occurred.	—	Replace the SERVOPACK.
A.E61: Command Option Module IF Synchronization Error 3	The timing of synchronization between the servomotor and command option module changed due to change in the communications cycle of the host controller connected to the command option module.	—	Turn the power supply OFF and then ON again. If the alarm occurs again, restart communications processing from the host controller.
	The connection between the SERVOPACK and the command option module is faulty.	Check the connection between the SERVOPACK and the command option module.	Correctly connect the command option module.
	A command option module fault occurred.	—	Replace the command option module.
	A SERVOPACK fault occurred.	—	Replace the SERVOPACK.
A.E70: Command Option Module Detection Failure	The connection between the SERVOPACK and the command option module is faulty.	Check the connection between the SERVOPACK and the command option module.	Correctly connect the command option module.
	The command option module is not connected.	—	Correctly connect the command option module.
	A command option module fault occurred.	—	Replace the command option module.
	A SERVOPACK fault occurred.	—	Replace the SERVOPACK.
A.E71: Safety Option Module Detection Failure	The connection between the SERVOPACK and the safety option module is faulty.	Check the connection between the SERVOPACK and the safety option module.	Correctly connect the safety option module.
	The safety option module was disconnected.	—	Execute Fn014 (Resetting configuration error of option module) with using the digital operator or SigmaWin+ and turn the power supply OFF and then ON again.
	A safety option module fault occurred.	—	Replace the safety option module.
	A SERVOPACK fault occurred.	—	Replace the SERVOPACK.

(cont'd)

Alarm: Alarm Name	Cause	Investigative Actions	Corrective Actions
A.E72*2: Feedback Option Module Detection Failure	The connection between the SERVOPACK and the feedback option module is faulty.	Check the connection between the SERVOPACK and the feedback option module.	Correctly connect the feedback option module.
	The feedback option module was disconnected.	—	Execute Fn014 (Resetting configuration error of option module) with the digital operator or SigmaWin+ and turn the power supply OFF and then ON again.
	A feedback option module fault occurred.	—	Replace the feedback option module.
	A SERVOPACK fault occurred.	—	Replace the SERVOPACK.
A.E73: Unsupported Option Module	A command option module fault occurred.	—	Replace the command option module.
	A unsupported command option module was connected.	Refer to the catalog of the connected command option module.	Connect a compatible command option module.
A.E74: Unsupported Safety Option Module	A safety option module fault occurred.	—	Replace the safety option module.
	A unsupported safety option module was connected.	Refer to the catalog of the connected safety option module.	Connect a compatible safety option module.
A.E75*2: Unsupported Feedback Option Module	A feedback option module fault occurred.	—	Replace the feedback option module.
	A unsupported feedback option module was connected.	Refer to the catalog of the connected feedback option module or the manual of the SERVOPACK.	Connect a compatible feedback option module.
A.E80: Command Option Module Unmatched Error	The command option module was replaced with a different model.	—	Execute Fn014 (Resetting configuration error of option module) with the digital operator or SigmaWin+ and turn the power supply OFF and then ON again.
A.EA2: DRV Alarm 2 (SERVOPACK WDC error)	The timing of synchronization between the servomotor and command option module changed due to change in the communications cycle of the host controller connected to the command option module.	—	Turn the power supply OFF and then ON again. If the alarm occurs again, restart communications processing from the host controller.
	The connection between the SERVOPACK and the command option module is faulty.	Check the connection between the SERVOPACK and the command option module.	Correctly connect the command option module.
	A command option module fault occurred.	—	Replace the command option module.
	A SERVOPACK fault occurred.	—	Replace the SERVOPACK.
A.Eb1: Safety Function Signal Input Timing Error	The lag between activations of the input signals /HWBB1 and /HWBB2 for the HWBB function is 10 seconds or more.	Measure the time lag between the /HWBB1 and /HWBB2 signals.	The host controller output signal circuits or devices for /HWBB1 and /HWBB2 or the SERVOPACK input signal circuits may be faulty. Alternatively, the input signal cables may be disconnected. Repair or replace them.
A.ED1: Command Option Module IF Command Timeout Error	Processing of the sensor ON command from the command option module is not completed.	—	Input a servo ON command when the motor is stopped.
	Processing of the sensor ON command from the command option module is not completed.	—	Check that the encoder is connected correctly and input a sensor ON command when the motor is stopped.

*2. The alarm may occur when a fully-closed option module is mounted.

(cont'd)

Alarm: Alarm Name	Cause	Investigative Actions	Corrective Actions
A.F10: Main Circuit Cable Open Phase (With the main power supply ON, voltage was low for more than 1 second in an R, S, or T phase.) (Detected when the main power supply was turned ON.)	The three-phase power supply wiring is incorrect.	Check the power supply wiring.	Confirm that the power supply is correctly wired.
	The three-phase power supply is unbalanced.	Measure the voltage at each phase of the three-phase power supply.	Balance the power supply by changing phases.
	A single-phase power is input without setting Pn00B.2 (power supply method for three-phase SERVOPACK) to 1 (single-phase power supply).	Check the power supply and the parameter setting.	Match the parameter setting to the power supply.
	A SERVOPACK fault occurred.	–	Turn the power supply OFF and then ON again. If the alarm still occurs, the SERVOPACK may be faulty. Replace the SERVOPACK.
CPF00: Digital Operator Transmission Error 1	The contact between the digital operator and the SERVOPACK is faulty.	Check the connector contact.	Insert securely the connector or replace the cable.
	Malfunction caused by noise interference	–	Keep the digital operator or the cable away from noise sources.
CPF01: Digital Operator Transmission Error 2	A digital operator fault occurred.	–	Disconnect the digital operator and then re-connect it. If the alarm still occurs, the digital operator may be faulty. Replace the digital operator.
	A SERVOPACK fault occurred.	–	Turn the power supply OFF and then ON again. If the alarm still occurs, the SERVOPACK may be faulty. Replace the SERVOPACK.

9.2 Warning Displays

The following sections describe troubleshooting in response to warning displays.

The warning name, warning meaning, and warning code output are listed in order of the warning numbers in *9.2.1 List of Warnings*.

The causes of alarms and troubleshooting methods are provided in *9.2.2 Troubleshooting of Warnings*.

9.2.1 List of Warnings

The relation between warning displays and warning code outputs are shown below.

Warning Display	Warning Name	Meaning
A.900	Position Error Pulse Overflow	Position error pulse exceeded the parameter settings (Pn520×Pn51E/100).
A.901	Position Error Pulse Overflow Alarm at Servo ON	When the servo turns ON, the position error pulses exceeded the parameter setting (Pn526×Pn528/100).
A.910	Overload	This warning occurs before the overload alarms (A.710 or A.720) occur. If the warning is ignored and operation continues, an overload alarm may occur.
A.911	Vibration	Abnormal vibration at the motor speed was detected. The detection level is the same as A.520. Set whether to output an alarm or warning by “Vibration Detection Switch” of Pn310.
A.920	Regenerative Overload	This warning occurs before the regenerative overload alarm (A.320) occurs. If the warning is ignored and operation continues, a regenerative overload alarm may occur.
A.921	Dynamic Brake Overload	This warning occurs before Dynamic Brake Overload (A.731) alarm occurs. If the warning is ignored and operation continues, a dynamic brake overload alarm may occur.
A.930	Absolute Encoder Battery Error	This warning occurs when the absolute encoder battery voltage is lowered.
A.94A	Command Option Module IF Data Setting Warning 1	This warning occurs when there is an error in a parameter number sent to the SERVOPACK from the host controller or command option module.
A.94B	Command Option Module IF Data Setting Warning 2	This warning occurs when out-of-range data is sent to the SERVOPACK from the host controller or command option module.
A.94C	Command Option Module IF Data Setting Warning 3	This warning occurs when there is an error in the parameter data sent to in the SERVOPACK from the host controller or command option module.
A.94D	Command Option Module IF Data Setting Warning 4	This warning occurs when there is an error in the data size sent to the SERVOPACK from the host controller or command option module.
A.94E	Command Option Module IF Data Setting Warning 5	This warning occurs when there is an error in the latch mode settings sent to the SERVOPACK from the host controller or command option module.
A.95A	Command Option Module IF Command Warning 1	This warning occurs when the host controller or command option module outputs an operating command when the operation execution conditions in the SERVOPACK have not been met.
A.95B	Command Option Module IF Command Warning 2	This warning occurs when there is an error in the reference output from the command option module to the SERVOPACK.
A.95D	Command Option Module IF Command Warning 4	This warning occurs when a latch command is output from the command option module to the SERVOPACK during latch operation.
A.95E	Command Option Module IF Command Warning 5	This warning occurs when an unallowed command combination is output to the SERVOPACK from the command option module.
A.95F	Command Option Module IF Command Warning 6	This warning occurs when there is an error in the command output to the SERVOPACK from the command option module.
A.960	Command Option Module IF Communications Warning	This warning occurs when an error occurred in communications between the SERVOPACK and command option module.

(cont'd)

Warning Display	Warning Name	Meaning
A.971	Undervoltage	This warning occurs before Undervoltage (A.410) alarm occurs. If the warning is ignored and operation continues, an undervoltage alarm may occur.

- Note 1. Set Pn001.3 = 1 (Outputs both Alarm Codes and Warning Codes) to output warning codes.
2. If Pn008.2 = 1 (Do not detect warning) is selected, no warnings will be detected.

9.2.2 Troubleshooting of Warnings

Refer to the following table to identify the cause of a warning and the action to be taken. Contact your Yaskawa representative if the problem cannot be solved by the described corrective action.

Warning Display	Warning Name	Situation at Warning Occurrence	Cause	Corrective Actions
A.900	Position Error Pulse Overflow	Wiring of the servomotor U, V, or W line is incorrect.	Check the wiring of the cable for motor main circuit.	Check whether there is any loose connection in motor wiring or encoder wiring.
		The SERVOPACK gain is too low.	Check the SERVOPACK gain.	Increase the servo gain by using the function such as advanced autotuning.
		The position reference acceleration is too high.	Lower the position reference acceleration.	Apply a smoothing function, such as a position reference acceleration/deceleration time constant (Pn216).
		The excessive position error alarm level (Pn520) is too low for the operating conditions.	Check the excessive position error alarm level (Pn520).	Set an appropriate value for the Pn520.
		A SERVOPACK fault occurred.	—	Turn the power supply OFF and then ON again. If the alarm still occurs, the SERVOPACK may be faulty. Replace the SERVOPACK.
A.901	Position Error Pulse Overflow Alarm at Servo ON	When the servomotor power was OFF, the servomotor moved without clearing the counter for position error pulses. The number of position error pulses exceeded the maximum number of pulses allowed.	—	Make the setting so that the position error pulse is cleared when the servo is OFF. Or, set an appropriate value for the excessive position error warning level at servo ON (Pn528).
A.910	Overload: Warning before alarm A.710 or A.720 occurs	The servomotor or encoder wiring is incorrect or the connection is faulty.	Check the wiring.	Correct the servomotor and encoder wiring if they are wrong.
		The servomotor is in excess of the overload protective characteristics.	Check the overload characteristics of the servomotor and reference input.	Reconsider the load and operation conditions. Or, check the servomotor capacity.
		The servomotor is not driven due to a mechanical factor and the operating load has become excessive.	Check the reference input and motor speed.	Improve the mechanical factor.
		A SERVOPACK fault occurred.	—	The SERVOPACK may be faulty. Replace the SERVOPACK.
A.911	Vibration	Abnormal vibration was detected while the motor was rotating.	Check whether unusual sound is generated from the motor, and check the speed and torque waveform of the motor.	Lower the motor rotation speed or the lower the servo gain by using the function such as one-parameter tuning.
		The moment of inertia ratio (Pn103) is larger than the actual value or greatly changes.	Check the moment of inertia ratio.	Set an appropriate value for the moment of inertia (Pn103).

(cont'd)

Warning Display	Warning Name	Situation at Warning Occurrence	Cause	Corrective Actions
A.920	Regenerative Overload: Warning before the alarm A.320 occurs	The power supply voltage exceeds the specified range.	Measure the power supply voltage.	Set the power supply voltage within the specified range.
		The external regenerative resistance, servo amplifier capacity, or regenerative resistor capacity is insufficient or a continuous regenerative state occurs.	Check the operating conditions or capacity using the capacity selection software SigmaJunmaSize+, etc.	Change the regenerative resistance, regenerative resistor capacity, or SERVOPACK capacity. Reconsider the operating conditions using the capacity selection software SigmaJunmaSize+, etc.
		Regenerative power continuously flowed back because negative load was continuously applied.	Check the load on the servomotor during operation.	Reconsider the system including the servo, machine, and operation conditions.
A.921	Dynamic Brake Overload: Warning before the alarm A.731 occurs	The servomotor is driven by an external force.	Check the operating conditions.	Do not drive the motor with external force.
		The rotating energy at a DB stop exceeds the DB resistance capacity.	Check the operating frequency of the DB with power consumed by DB resistance monitor (Un00B).	<ul style="list-style-type: none"> Reduce the servomotor reference speed. Reduce the moment of inertia. Reduce the number of times of the DB stop operation.
		A SERVOPACK fault occurred.	—	The SERVOPACK may be faulty. Replace the SERVOPACK.
A.930	Absolute Encoder Battery Error (The absolute encoder battery voltage is lower than the specified value.) (Only when an absolute encoder is connected.)	The battery connection is incorrect.	Check the battery connection.	Connect the battery correctly.
		The battery voltage is lower than the specified value 2.7 V.	Measure the battery voltage.	Replace the battery.
		A SERVOPACK fault occurred.	—	The SERVOPACK may be faulty. Replace the SERVOPACK.
A.94A	Command Option Module IF Data Setting Warning 1	An incorrect parameter number was sent to the SERVOPACK from the host controller or command option module.	—	Specify the correct parameter number.
A.94B	Command Option Module IF Data Setting Warning 2	Out-of-range data was sent to the SERVOPACK from the host controller or command option module.	—	Specify the value of the parameter within the allowable range.
A.94C	Command Option Module IF Data Setting Warning 3	Incorrect parameter data was sent to the SERVOPACK from the host controller or command option module.	—	Specify the value of the parameter within the allowable range.
A.94D	Command Option Module IF Data Setting Warning 4	The incorrect parameter size was sent to the SERVOPACK from the host controller or command option module.	—	Specify the correct parameter size.

(cont'd)

Warning Display	Warning Name	Situation at Warning Occurrence	Cause	Corrective Actions
A.94E	Command Option Module IF Data Setting Warning 5	Incorrect latch mode settings were sent to the SERVOPACK from the host controller or command option module.	—	Set a proper value for the latch mode.
A.95A	Command Option Module IF Command Warning 1	The host controller or command option module sent a operating command when the operation execution conditions in the SERVOPACK had not been satisfied.	—	Send a command after the operation conditions are satisfied.
A.95B	Command Option Module IF Command Warning 2	The command option module sent a command that is not supported by the SERVOPACK.	—	Send a command that is supported by the SERVOPACK.
A.95D	Command Option Module IF Command Warning 4	A latch command was sent from the command option module during latch operation.	—	Review the input sequence for the latch command.
A.95E	Command Option Module IF Command Warning 5	An unallowed command combination was output to the SERVOPACK from the command option module.	—	Send a command that can be combined.
A.95F	Command Option Module IF Command Warning 6	The command option module sent a command that is not supported by the SERVOPACK.	—	Send a command that is supported by the SERVOPACK.
A.960	Command Option Module IF Communications Warning	An error occurred in communications between the SERVOPACK and command option module due to noise.	—	Take measures against noise.
		The connection between the SERVOPACK and the command option module is faulty.	Check the connection between the SERVOPACK and the command option module.	Correctly connect the command option module.
		A command option module fault occurred.	—	Replace the command option module.
		A SERVOPACK fault occurred.	—	Replace the SERVOPACK.

(cont'd)

Warning Display	Warning Name	Situation at Warning Occurrence	Cause	Corrective Actions
A.971	Undervoltage	<ul style="list-style-type: none"> • For 100-VAC SERVOPACKs: The AC power supply voltage is 60 V or below. • For 200-VAC SERVOPACKs: The AC power supply voltage is 140 V or below. • For 400-VAC SERVOPACKs: The AC power supply voltage is 280 V or below. 	Measure the power supply voltage.	Use a power supply voltage within the specified range.
		The power supply voltage dropped during operation.	Measure the power supply voltage.	Increase the power supply capacity.
		An instantaneous power failure occurred.	Measure the power supply voltage.	Lower the instantaneous power cut hold time (Pn509).
		The fuse in the SERVOPACK is burned out.	–	Replace the SERVOPACK and connect an AC/DC reactor to the SERVOPACK.
		A SERVOPACK fault occurred.	–	The SERVOPACK may be faulty. Replace the SERVOPACK.

9.3 Troubleshooting Malfunction Based on Operation and Conditions of the Servomotor

Troubleshooting for the malfunctions based on the operation and conditions of the servomotor is provided in this section.

Be sure to turn OFF the servo system before troubleshooting items outlined in bold in the table.

Problem	Probable Cause	Investigative Actions	Corrective Actions
Servomotor Does Not Start	The control power supply is not ON.	Check voltage between power supply terminals.	Correct the power circuit.
	The main circuit power supply is not ON.	Check the voltage between power supply terminals.	Correct the power circuit.
	Wiring of I/O signal connector CN1 faulty or disconnected.	Check if the connector CN1 is properly inserted and connected.	Correct the connector CN1 connection.
	Servomotor or encoder wiring disconnected.	Check the wiring.	Correct the wiring.
	Overloaded	Run under no load and check the load status.	Reduce load or replace with larger capacity servomotor.
	Setting for Pn50A, Pn50B and Pn511 "Input Signal Selection" is incorrect.	Check settings of parameters Pn50A, Pn50B and Pn511.	Correct the settings for Pn50A, Pn50B and Pn511 "Input Signal Selection."
	Encoder type differs from parameter setting (Pn002.2).	Check setting of parameter Pn002.2.	Set parameter Pn002.2 to the encoder type being used.
	A servo ON command was not input.	Check the command sent from the host controller.	Send a servo ON command.
	A sensor ON command was not input.	Check the command sent from the host controller.	Send the command in the correct sequence to the SERVOPACK.
	The forward run prohibited (P-OT) and reverse run prohibited (N-OT) input signals are turned OFF.	Check P-OT or N-OT input signal.	Turn P-OT or N-OT input signal ON.
	The safety input signal (/HWBB1 or /HWBB2) remains OFF.	Check the /HWBB1 or /HWBB2 input signal.	Set the /HWBB1 or /HWBB2 input signal to ON. When not using the safety function, mount the safety function jumper connector (provided as an accessory) on the CN8.
A SERVOPACK fault occurred.	–	Replace the SERVOPACK.	
Servomotor Moves Instantaneously, and then Stops	Servomotor wiring is incorrect.	Check the servomotor wiring.	Correct the wiring.
	Encoder wiring is incorrect.	Check the encoder wiring.	Correct the wiring.
Servomotor Speed Unstable	Wiring connection to servomotor is defective.	Check connections of main circuit cable (phases-U, -V, and -W) and encoder connectors.	Tighten any loose terminals or connectors.
Servomotor Rotates Without Reference Input	A SERVOPACK fault occurred.	–	Replace the SERVOPACK.
Dynamic Brake Does Not Operate	Setting for Pn001 is incorrect.	Check the setting of parameter Pn001.0.	Correct the parameter setting.
	DB resistor disconnected	Check if excessive moment of inertia, motor overspeed, or DB frequently activated occurred.	Replace the SERVOPACK, and lighten the load to avoid disconnection.
	DB drive circuit fault	–	There is a defective component in the DB circuit. Replace the SERVOPACK.

(cont'd)

Problem	Probable Cause	Investigative Actions	Corrective Actions
Abnormal Noise from Servomotor	The servomotor largely vibrated during execution of tuning-less function.	Check the servomotor speed waveform.	Reduce the load so that the moment of inertia ratio becomes within the allowable value, or increase the load level or lower the tuning level for the tuning-less level setting (Fn200).
	Mounting is not secured.	Check if there are any loose mounting screws.	Tighten the mounting screws.
		Check if there is misalignment of couplings.	Align the couplings.
		Check if there are unbalanced couplings.	Balance the couplings.
	Bearings are defective.	Check for noise and vibration around the bearings.	Replace the servomotor.
	Vibration source at the driven machine	Check for any foreign matter, damage, or deformations on the machinery's movable parts.	Contact the machine manufacturer.
	Noise interference due to incorrect input/output signal cable specifications	The input/output signal cables must be tinned annealed copper twisted-pair or shielded twisted-pair cables with a core of 0.12 mm ² min.	Use the specified input signal wires.
	Noise interference due to length of input/output signal cable.	Check the length of the input/output cable.	The input/output cable length must be no more than 3 m.
	Noise interference due to incorrect encoder cable specifications.	The encoder cable must be tinned annealed copper twisted-pair or shielded twisted-pair cables with a core of 0.12 mm ² min.	Use the specified encoder cable.
	Noise interference due to length of encoder cable wiring	Check the length of the encoder cable.	The encoder cable must be no more than 20 m.
	Noise interference due to damaged encoder cable	Check if the encoder cable is damaged or bent.	Replace the encoder cable and modify the encoder cable layout.
	Excessive noise to the encoder cable	Check if the encoder cable is bundled with high-current line or near a high-current line.	Correct the encoder cable layout so that no surge is applied.
	FG potential varies because of influence of machines such as welders at the servomotor.	Check if the machines are correctly grounded.	Ground machines correctly, and prevent diversion to the FG at the PG side.
	SERVOPACK pulse counting error due to noise interference	Check if there is noise interference on the input/output signal line from the encoder.	Take measures against noise in the encoder wiring.
Servomotor Vibrates at Frequency of Approx. 200 to 400 Hz	Excessive vibration and shock to the encoder	Check if vibration from the machine occurred or servomotor installation is incorrect (mounting surface accuracy, fixing, alignment, etc.).	Reduce vibration from the machine, or secure the servomotor installation.
	An encoder fault occurred.	–	Replace the servomotor.
	Unbalanced servo gains	Check to see if the servo gains have been correctly adjusted.	Execute the advanced autotuning.
	Speed loop gain value (Pn100) too high.	Check the speed loop gain value (Pn100). Factory setting: K _v = 40.0 Hz	Reduce the speed loop gain (Pn100).
	Position loop gain value (Pn102) too high.	Check the position loop gain value (Pn102). Factory setting: K _p = 40.0/s	Reduce the position loop gain (Pn102).
Incorrect speed loop integral time constant (Pn101) setting	Check the speed loop integral time constant (Pn101). Factory setting: T _i = 20.0 ms	Correct the speed loop integral time constant (Pn101) setting.	
Incorrect moment of inertia ratio data (Pn103)	Check the moment of inertia ratio setting (Pn103).	Correct the moment of inertia ratio (Pn103) setting.	

(cont'd)

Problem	Probable Cause	Investigative Actions	Corrective Actions
High Rotation Speed Overshoot on Starting and Stopping	Unbalanced servo gains	Check to see if the servo gains have been correctly adjusted.	Execute the advanced autotuning.
	Speed loop gain value (Pn100) too high	Check the speed loop gain value (Pn100). Factory setting: $K_v = 40.0$ Hz	Reduce the speed loop gain (Pn100).
	Position loop gain value (Pn102) too high	Check the position loop gain value (Pn102). Factory setting: $K_p = 40.0/s$	Reduce the position loop gain (Pn102).
	Incorrect speed loop integral time constant (Pn101) setting	Check the speed loop integral time constant (Pn101). Factory setting: $T_i = 20.0$ ms	Correct the speed loop integral time constant setting (Pn101).
	Incorrect moment of inertia ratio data (Pn103)	Check the moment of inertia ratio setting (Pn103).	Correct the moment of inertia ratio setting (Pn103).
Absolute Encoder Position Difference Error (The position saved in the host controller when the power was turned OFF is different from the position when the power is next turned ON.)	Noise interference due to improper encoder cable specifications	The encoder cable must be tinned annealed copper twisted-pair or shielded twisted-pair cables with a core of 0.12 mm ² min.	Use encoder cable with the specified specifications.
	Noise interference due to length of encoder cable.	Check the encoder cable length.	The encoder cable length must be no more than 20 m.
	Noise interference due to damaged encoder cable	Check if the encoder cable is bent or if its sheath is damaged.	Replace the encoder cable and correct the encoder cable layout.
	Excessive noise interference at the encoder cable	Check if the encoder cable is bundled with a high-current line or near high-current line.	Change the encoder cable layout so that no surge is applied.
	FG potential varies because of influence of machines such as welders at the servomotor.	Check if the machines are correctly grounded.	Ground machines correctly, and prevent diversion to the FG at the PG side.
	SERVOPACK pulse counting error due to noise interference	Check if there is noise interference on the input/output signal line from the encoder.	Take measures against noise in the encoder wiring.
	Excessive vibration and shock to the encoder	Check if vibration from the machine occurred or servomotor installation is incorrect (mounting surface accuracy, fixing, alignment, etc.).	Reduce vibration from the machine, or secure the servomotor installation.
	An encoder fault occurred.	–	Replace the servomotor.
	A SERVOPACK fault occurred. (The pulse count does not change.)	–	Replace the SERVOPACK.
	Host controller multi-turn data reading error	Check the error detection at the host controller.	Correct the error detection section of the host controller.
Check if the host controller is executing data parity checks.		Execute a multi-turn data parity check.	
Check noise in the input/output signal line between the SERVOPACK and the host controller.		Take measures against noise, and again execute a multiturn data parity check.	

(cont'd)

Problem	Probable Cause	Investigative Actions	Corrective Actions
Overtravel (OT)	Forward or reverse run prohibited signal is input.	Check the external power supply (+24 V) voltage for the input signal.	Correct the external power supply (+24 V) voltage.
		Check if the overtravel limit switch operates properly.	Correct the overtravel limit switch.
		Check if the overtravel limit switch is wired correctly.	Correct the overtravel limit switch wiring.
		Check the settings for Pn50A and Pn50B.	Set the parameters correctly.
	Forward or reverse run prohibited signal is malfunctioning.	Check the fluctuation of the input signal external power supply (+24 V) voltage.	Stabilize the external power supply (+24 V) voltage.
		Check if the overtravel limit switch operates correctly.	Stabilize the operation of the overtravel limit switch.
		Check if the overtravel limit switch wiring is correct. (check for damaged cables or loose screws.)	Correct the overtravel limit switch wiring.
	Incorrect forward or reverse run prohibited signal (P-OT/N-OT) allocation (parameters Pn50A.3, Pn50B.0)	Check if the P-OT signal is allocated in Pn50A.3.	If another signal is allocated in Pn50A.3, select P-OT.
		Check if the N-OT signal is allocated in Pn50B.0.	If another signal is allocated in Pn50B.0, select N-OT.
	Incorrect servomotor stop method selection	Check Pn001.0 and Pn001.1 when the servomotor power is OFF.	Select a servo mode stop method other than “coast to stop.”
Check Pn001.0 and Pn001.1 when in torque control.		Select a servo mode stop method other than “coast to stop.”	
Improper Position to Stop by Overtravel (OT) Signal	Improper limit switch position and dog length	–	Install the limit switch at the appropriate position.
	The overtravel limit switch position is too short for the coasting distance.	–	Install the overtravel limit switch at the appropriate position.
Position Error (Without Alarm)	Noise interference due to improper encoder cable specifications	The encoder cable must be tinned annealed copper twisted-pair or shielded twisted-pair cable with a core of 0.12 mm ² min.	Use encoder cable with the specified specifications.
	Noise interference due to length of encoder cable	Check the encoder cable length.	The encoder cable length must be less than 20 m.
	Noise influence due to damaged encoder cable	Check if the encoder cable is bent or if its sheath is damaged.	Replace the encoder cable and correct the encoder cable layout.
	Excessive noise interference to encoder cable	Check if the encoder cable is bundled with a high-current line or near a high-current line.	Change the encoder cable layout so that no surge is applied.
	FG potential varies because of influence of machines such as welders at the servomotor.	Check if the machines are correctly grounded.	Ground machines correctly, and prevent diversion to the FG at the PG side.
	SERVOPACK pulse count error due to noise	Check if the input/output signal line from the encoder is influenced by noise.	Take measures against noise in the encoder wiring.
	Excessive vibration and shock to the encoder	Check if vibration from the machine occurred or servomotor installation is incorrect (mounting surface accuracy, fixing, alignment, etc.).	Reduce the machine vibration or mount the servomotor securely.
	Unsecured coupling between machine and servomotor	Check if a position error occurs at the coupling between machine and servomotor.	Secure the coupling between the machine and servomotor.
	Noise interference due to improper I/O signal cable specifications	The I/O signal cable must be twisted-pair or shielded twisted-pair cable with a core of 0.12 mm ² min. and tinned annealed copper twisted wire.	Use input signal cable with the specified specifications.

(cont'd)

Problem	Probable Cause	Investigative Actions	Corrective Actions
Position Error (Without Alarm) (cont'd)	Noise interference due to length of I/O signal cable	Check the I/O signal cable length.	The I/O signal cable length must be less than 3 m.
	An encoder fault occurred. (The pulse count does not change.)	–	Replace the servomotor.
	A SERVOPACK fault occurred.	–	Replace the SERVOPACK.
Servomotor Overheated	Ambient temperature too high	Measure the servomotor ambient temperature.	Lower the ambient temperature to 40°C or less.
	Servomotor surface dirty	Visually check the surface.	Clean dust and oil from the surface.
	Servomotor overloaded	Check the load status with monitor.	If overloaded, reduce load or replace with larger capacity servomotor.

10

Appendix

- 10.1 List of Parameters 10-2
 - 10.1.1 Utility Functions 10-2
 - 10.1.2 Parameters 10-3
- 10.2 Monitor Modes 10-22
- 10.3 Parameter Recording Table 10-23

10.1 List of Parameters

10.1.1 Utility Functions

The following table lists the available utility functions.

Parameter No.	Function	Reference Section
Fn000	Alarm history display	6.2
Fn002	JOG operation	6.3
Fn003	Origin search	6.4
Fn004	Program JOG operation	6.5
Fn005	Initializing parameter settings	6.6
Fn006	Clearing alarm history	6.7
Fn008	Absolute encoder multi-turn reset and encoder alarm reset	4.5.4
Fn00C	Offset adjustment of analog monitor output	6.8
Fn00D	Gain adjustment of analog monitor output	6.9
Fn00E	Automatic offset-signal adjustment of motor current detection	6.10
Fn00F	Manual offset-signal adjustment of motor current detection	6.11
Fn010	Write prohibited setting	6.12
Fn011	Servomotor model display	6.13
Fn012	Software version display	6.14
Fn013	Multi-turn limit value setting change when a multi-turn limit disagreement alarm occurs	4.5.7
Fn014	Resetting configuration error of option module	6.15
Fn01B	Vibration detection level initialization	6.16
Fn01E	Display of SERVOPACK and servomotor ID	6.17
Fn01F	Display of servomotor ID in feedback option module	6.18
Fn020	Origin setting	6.19
Fn030	Software reset	6.20
Fn200	Tuning-less level setting	5.2.2
Fn201	Advanced autotuning	5.3.2
Fn202	Advanced autotuning by reference	5.4.2
Fn203	One-parameter tuning	5.5.2
Fn204	Anti-resonance control adjustment function	5.6.2
Fn205	Vibration suppression function	5.7.2
Fn206	EasyFTT	6.21
Fn207	Online vibration monitor	6.22

Note: A setting may be write-prohibited if the digital operator displays “NO-OP” when any of the above utility function is executed. For details, refer to 6.12 *Write Prohibited Setting (Fn010)*.

10.1.2 Parameters

Parameter No.	Name	Setting Range	Units	Factory Setting	When Enabled	Classification	Reference Section	
Pn000	Basic Function Select Switch 0	0000 to 00B3	–	0000	After restart	Setup	–	
	Direction Selection (Refer to 4.2.2)							
	0 Forward reference for forward rotation.							
	1 Forward reference for reverse rotation. (Reverse rotation mode)							
	2 to 3 Reserved (Do not change.)							
	Reserved (Do not change.)							
	Reserved (Do not change.)							
	Reserved (Do not change.)							
	Pn001	Application Function Select Switch 1	0000 to 1122	–	0000	After restart	Setup	–
Servomotor power OFF or Alarm Gr.1 Stop Mode (Refer to 4.2.8)								
0 Stops the motor by applying DB (dynamic brake).								
1 Stops the motor by applying dynamic brake (DB) and then releases DB.								
2 Makes the motor coast to a stop state without using the dynamic brake (DB).								
Overtravel (OT) Stop Mode (Refer to 4.2.3)								
0 Same setting as Pn001.0 (Stops the motor by applying DB or by coasting).								
1 Sets the torque of Pn406 to the maximum value, decelerate the servomotor to a stop, and then sets it to servolock state.								
2 Sets the torque of Pn406 to the maximum value, decelerates the servomotor to a stop, and then sets it to coasting state.								
AC/DC Power Input Selection (Refer to 3.1.4)								
0 Not applicable to DC power input: Input AC power supply through L1, L2 (, and L3) terminals.								
1 Applicable to DC power input: Input DC power supply between B1/+ and –, or input DC power supply between B1 and –2.								
Reserved (Do not change.)								

(cont'd)

Parameter No.	Name	Setting Range	Units	Factory Setting	When Enabled	Classification	Reference Section																																				
Pn002	Application Function Select Switch 2	0000 to 4113	–	0000	After restart	Setup	–																																				
	<div style="display: flex; justify-content: space-around; margin-bottom: 5px;"> 4th digit 3rd digit 2nd digit 1st digit </div> <div style="display: flex; align-items: center; margin-bottom: 5px;"> n. <div style="display: flex; gap: 10px;"> <input type="checkbox"/> <input type="checkbox"/> <input type="checkbox"/> <input type="checkbox"/> </div> </div> <table border="1" style="width: 100%; border-collapse: collapse;"> <thead> <tr style="background-color: #cccccc;"> <th colspan="2">Torque Limit Reference Selection for Command Option Module*1</th> </tr> </thead> <tbody> <tr><td>0</td><td>Disables the torque limit reference from the command option module.</td></tr> <tr><td>1</td><td>Enables the torque limit reference from the command option module.</td></tr> <tr><td>2</td><td>Reserved (Do not change.)</td></tr> <tr><td>3</td><td>Enables torque limit reference from the command option module when external input signals P-CL and N-CL are enabled.</td></tr> </tbody> </table> <table border="1" style="width: 100%; border-collapse: collapse;"> <thead> <tr style="background-color: #cccccc;"> <th colspan="2">Speed Limit Reference Selection for Command Option Module*1</th> </tr> </thead> <tbody> <tr><td>0</td><td>Disables the speed limit reference when torque limit is used from the command option module.</td></tr> <tr><td>1</td><td>Enables the speed limit reference when torque limit is used from the command option module.</td></tr> </tbody> </table> <table border="1" style="width: 100%; border-collapse: collapse;"> <thead> <tr style="background-color: #cccccc;"> <th colspan="2">Absolute Encoder Usage</th> <th style="text-align: right;">(Refer to 4.5)</th> </tr> </thead> <tbody> <tr><td>0</td><td>Uses absolute encoder as an absolute encoder.</td></tr> <tr><td>1</td><td>Uses absolute encoder as an incremental encoder.</td></tr> </tbody> </table> <table border="1" style="width: 100%; border-collapse: collapse;"> <thead> <tr style="background-color: #cccccc;"> <th colspan="2">External Encoder Usage</th> <th style="text-align: right;">(Refer to 8.3.1)</th> </tr> </thead> <tbody> <tr><td>0</td><td>Do not use external encoder.</td></tr> <tr><td>1</td><td>Uses external encoder in forward rotation direction.</td></tr> <tr><td>2</td><td>Reserved (Do not change.)</td></tr> <tr><td>3</td><td>Uses external encoder in reversed rotation direction.</td></tr> <tr><td>4</td><td>Reserved (Do not change.)</td></tr> </tbody> </table>	Torque Limit Reference Selection for Command Option Module*1		0	Disables the torque limit reference from the command option module.	1	Enables the torque limit reference from the command option module.	2	Reserved (Do not change.)	3	Enables torque limit reference from the command option module when external input signals P-CL and N-CL are enabled.	Speed Limit Reference Selection for Command Option Module*1		0	Disables the speed limit reference when torque limit is used from the command option module.	1	Enables the speed limit reference when torque limit is used from the command option module.	Absolute Encoder Usage		(Refer to 4.5)	0	Uses absolute encoder as an absolute encoder.	1	Uses absolute encoder as an incremental encoder.	External Encoder Usage		(Refer to 8.3.1)	0	Do not use external encoder.	1	Uses external encoder in forward rotation direction.	2	Reserved (Do not change.)	3	Uses external encoder in reversed rotation direction.	4	Reserved (Do not change.)						
	Torque Limit Reference Selection for Command Option Module*1																																										
	0	Disables the torque limit reference from the command option module.																																									
	1	Enables the torque limit reference from the command option module.																																									
	2	Reserved (Do not change.)																																									
	3	Enables torque limit reference from the command option module when external input signals P-CL and N-CL are enabled.																																									
	Speed Limit Reference Selection for Command Option Module*1																																										
	0	Disables the speed limit reference when torque limit is used from the command option module.																																									
	1	Enables the speed limit reference when torque limit is used from the command option module.																																									
	Absolute Encoder Usage		(Refer to 4.5)																																								
	0	Uses absolute encoder as an absolute encoder.																																									
	1	Uses absolute encoder as an incremental encoder.																																									
	External Encoder Usage		(Refer to 8.3.1)																																								
	0	Do not use external encoder.																																									
	1	Uses external encoder in forward rotation direction.																																									
	2	Reserved (Do not change.)																																									
	3	Uses external encoder in reversed rotation direction.																																									
	4	Reserved (Do not change.)																																									
	Pn006	Application Function Select Switch 6	0000 to 005F	–	0002	Immediately	Setup	–																																			
<div style="display: flex; justify-content: space-around; margin-bottom: 5px;"> 4th digit 3rd digit 2nd digit 1st digit </div> <div style="display: flex; align-items: center; margin-bottom: 5px;"> n. <div style="display: flex; gap: 10px;"> <input type="checkbox"/> <input type="checkbox"/> <input type="checkbox"/> <input type="checkbox"/> </div> </div> <table border="1" style="width: 100%; border-collapse: collapse;"> <thead> <tr style="background-color: #cccccc;"> <th colspan="2">Analog Monitor 1 Signal Selection</th> <th style="text-align: right;">(Refer to 5.1.3)</th> </tr> </thead> <tbody> <tr><td>00</td><td>Motor speed (1 V/1000 min⁻¹)</td></tr> <tr><td>01</td><td>Speed reference (1 V/1000 min⁻¹)</td></tr> <tr><td>02</td><td>Torque reference (1 V/100%)</td></tr> <tr><td>03</td><td>Position error (0.05 V/1 reference unit)</td></tr> <tr><td>04</td><td>Position amplifier error (after electronic gears) (0.05 V/ 1 encoder pulse unit)</td></tr> <tr><td>05</td><td>Position reference speed (1 V/1000 min⁻¹)</td></tr> <tr><td>06</td><td>Reserved (Do not change.)</td></tr> <tr><td>07</td><td>Motor-load position error (0.01 V/1 reference unit)</td></tr> <tr><td>08</td><td>Positioning completion (positioning completed: 5 V, positioning not completed: 0 V)</td></tr> <tr><td>09</td><td>Speed feedforward (1 V/1000 min⁻¹)</td></tr> <tr><td>0A</td><td>Torque feedforward (1 V/100%)</td></tr> <tr><td>0B</td><td>Active gain (1st gain: 1 V, 2nd gain: 2 V)</td></tr> <tr><td>0C</td><td>Completion of position reference (completed: 5 V, not completed: 0 V)</td></tr> <tr><td>0D</td><td>External encoder speed (1 V/1000 min⁻¹)</td></tr> </tbody> </table> <table border="1" style="width: 100%; border-collapse: collapse;"> <tr style="background-color: #cccccc;"><td colspan="2">Reserved (Do not change.)</td></tr> <tr style="background-color: #cccccc;"><td colspan="2">Reserved (Do not change.)</td></tr> </table>		Analog Monitor 1 Signal Selection		(Refer to 5.1.3)	00	Motor speed (1 V/1000 min ⁻¹)	01	Speed reference (1 V/1000 min ⁻¹)	02	Torque reference (1 V/100%)	03	Position error (0.05 V/1 reference unit)	04	Position amplifier error (after electronic gears) (0.05 V/ 1 encoder pulse unit)	05	Position reference speed (1 V/1000 min ⁻¹)	06	Reserved (Do not change.)	07	Motor-load position error (0.01 V/1 reference unit)	08	Positioning completion (positioning completed: 5 V, positioning not completed: 0 V)	09	Speed feedforward (1 V/1000 min ⁻¹)	0A	Torque feedforward (1 V/100%)	0B	Active gain (1st gain: 1 V, 2nd gain: 2 V)	0C	Completion of position reference (completed: 5 V, not completed: 0 V)	0D	External encoder speed (1 V/1000 min ⁻¹)	Reserved (Do not change.)		Reserved (Do not change.)								
Analog Monitor 1 Signal Selection		(Refer to 5.1.3)																																									
00		Motor speed (1 V/1000 min ⁻¹)																																									
01		Speed reference (1 V/1000 min ⁻¹)																																									
02		Torque reference (1 V/100%)																																									
03		Position error (0.05 V/1 reference unit)																																									
04		Position amplifier error (after electronic gears) (0.05 V/ 1 encoder pulse unit)																																									
05		Position reference speed (1 V/1000 min ⁻¹)																																									
06		Reserved (Do not change.)																																									
07		Motor-load position error (0.01 V/1 reference unit)																																									
08		Positioning completion (positioning completed: 5 V, positioning not completed: 0 V)																																									
09		Speed feedforward (1 V/1000 min ⁻¹)																																									
0A		Torque feedforward (1 V/100%)																																									
0B		Active gain (1st gain: 1 V, 2nd gain: 2 V)																																									
0C		Completion of position reference (completed: 5 V, not completed: 0 V)																																									
0D		External encoder speed (1 V/1000 min ⁻¹)																																									
Reserved (Do not change.)																																											
Reserved (Do not change.)																																											

*1. For details on this function, refer to the manual of the connected command option module.

(cont'd)

Parameter No.	Name	Setting Range	Units	Factory Setting	When Enabled	Classification	Reference Section																																		
Pn007	Application Function Select Switch 7	0000 to 005F	–	0000	Immediately	Setup	–																																		
	<div style="display: flex; justify-content: space-around; align-items: flex-start;"> <div style="text-align: center;"> <p>4th digit</p> <input type="checkbox"/> </div> <div style="text-align: center;"> <p>3rd digit</p> <input type="checkbox"/> </div> <div style="text-align: center;"> <p>2nd digit</p> <input type="checkbox"/> </div> <div style="text-align: center;"> <p>1st digit</p> <input type="checkbox"/> </div> </div> <p>n.</p>	<table border="1" style="width: 100%; border-collapse: collapse;"> <thead> <tr> <th colspan="2" style="text-align: left;">Analog Monitor 2 Signal Selection (Refer to 5.1.3)</th> </tr> </thead> <tbody> <tr><td>00</td><td>Motor speed (1 V/1000 min⁻¹)</td></tr> <tr><td>01</td><td>Speed reference (1 V/1000 min⁻¹)</td></tr> <tr><td>02</td><td>Torque reference (1 V/100%)</td></tr> <tr><td>03</td><td>Position error (0.05 V/1 reference unit)</td></tr> <tr><td>04</td><td>Position amplifier error (after electronic gears) (0.05 V/ 1 encoder pulse unit)</td></tr> <tr><td>05</td><td>Position reference speed (1 V/1000 min⁻¹)</td></tr> <tr><td>06</td><td>Reserved (Do not change.)</td></tr> <tr><td>07</td><td>Motor-load position error (0.01 V/1 reference unit)</td></tr> <tr><td>08</td><td>Positioning completion (positioning completed: 5 V, positioning not completed: 0 V)</td></tr> <tr><td>09</td><td>Speed feedforward (1 V/1000 min⁻¹)</td></tr> <tr><td>0A</td><td>Torque feedforward (1 V/100%)</td></tr> <tr><td>0B</td><td>Active gain (1st gain: 1 V, 2nd gain: 2 V)</td></tr> <tr><td>0C</td><td>Completion of position reference (completed: 5 V not completed: 0 V)</td></tr> <tr><td>0D</td><td>External encoder speed (1 V/1000 min⁻¹)</td></tr> <tr><td colspan="2" style="background-color: #cccccc;">Reserved (Do not change.)</td></tr> <tr><td colspan="2" style="background-color: #cccccc;">Reserved (Do not change.)</td></tr> </tbody> </table>						Analog Monitor 2 Signal Selection (Refer to 5.1.3)		00	Motor speed (1 V/1000 min ⁻¹)	01	Speed reference (1 V/1000 min ⁻¹)	02	Torque reference (1 V/100%)	03	Position error (0.05 V/1 reference unit)	04	Position amplifier error (after electronic gears) (0.05 V/ 1 encoder pulse unit)	05	Position reference speed (1 V/1000 min ⁻¹)	06	Reserved (Do not change.)	07	Motor-load position error (0.01 V/1 reference unit)	08	Positioning completion (positioning completed: 5 V, positioning not completed: 0 V)	09	Speed feedforward (1 V/1000 min ⁻¹)	0A	Torque feedforward (1 V/100%)	0B	Active gain (1st gain: 1 V, 2nd gain: 2 V)	0C	Completion of position reference (completed: 5 V not completed: 0 V)	0D	External encoder speed (1 V/1000 min ⁻¹)	Reserved (Do not change.)		Reserved (Do not change.)	
	Analog Monitor 2 Signal Selection (Refer to 5.1.3)																																								
	00	Motor speed (1 V/1000 min ⁻¹)																																							
	01	Speed reference (1 V/1000 min ⁻¹)																																							
	02	Torque reference (1 V/100%)																																							
	03	Position error (0.05 V/1 reference unit)																																							
	04	Position amplifier error (after electronic gears) (0.05 V/ 1 encoder pulse unit)																																							
	05	Position reference speed (1 V/1000 min ⁻¹)																																							
	06	Reserved (Do not change.)																																							
	07	Motor-load position error (0.01 V/1 reference unit)																																							
	08	Positioning completion (positioning completed: 5 V, positioning not completed: 0 V)																																							
	09	Speed feedforward (1 V/1000 min ⁻¹)																																							
	0A	Torque feedforward (1 V/100%)																																							
	0B	Active gain (1st gain: 1 V, 2nd gain: 2 V)																																							
	0C	Completion of position reference (completed: 5 V not completed: 0 V)																																							
	0D	External encoder speed (1 V/1000 min ⁻¹)																																							
	Reserved (Do not change.)																																								
	Reserved (Do not change.)																																								
	Pn008	Application Function Select Switch 8	0000 to 7121	–	4000	After restart	Setup	–																																	
		<div style="display: flex; justify-content: space-around; align-items: flex-start;"> <div style="text-align: center;"> <p>4th digit</p> <input type="checkbox"/> </div> <div style="text-align: center;"> <p>3rd digit</p> <input type="checkbox"/> </div> <div style="text-align: center;"> <p>2nd digit</p> <input type="checkbox"/> </div> <div style="text-align: center;"> <p>1st digit</p> <input type="checkbox"/> </div> </div> <p>n.</p>	<table border="1" style="width: 100%; border-collapse: collapse;"> <tbody> <tr> <td colspan="2" style="background-color: #cccccc;">Lowered Battery Voltage Alarm/Warning Selection (Refer to 4.5.4)</td> </tr> <tr><td>0</td><td>Outputs alarm (A.830) for lowered battery voltage.</td></tr> <tr><td>1</td><td>Outputs warning (A.930) for lowered battery voltage.</td></tr> <tr> <td colspan="2" style="background-color: #cccccc;">Function Selection for Insufficient voltage (Refer to 4.2.10)</td> </tr> <tr><td>0</td><td>Disables detection of insufficient voltages.</td></tr> <tr><td>1</td><td>Detects warning and limits torque by host controller.</td></tr> <tr><td>2</td><td>Detects warning and limits torque by Pn424 and Pn425.</td></tr> <tr> <td colspan="2" style="background-color: #cccccc;">Warning Detection Selection (Refer to 9.2.1)</td> </tr> <tr><td>0</td><td>Detects warning.</td></tr> <tr><td>1</td><td>Does not detect warning.</td></tr> <tr><td colspan="2" style="background-color: #cccccc;">Reserved (Do not change.)</td></tr> </tbody> </table>						Lowered Battery Voltage Alarm/Warning Selection (Refer to 4.5.4)		0	Outputs alarm (A.830) for lowered battery voltage.	1	Outputs warning (A.930) for lowered battery voltage.	Function Selection for Insufficient voltage (Refer to 4.2.10)		0	Disables detection of insufficient voltages.	1	Detects warning and limits torque by host controller.	2	Detects warning and limits torque by Pn424 and Pn425.	Warning Detection Selection (Refer to 9.2.1)		0	Detects warning.	1	Does not detect warning.	Reserved (Do not change.)												
		Lowered Battery Voltage Alarm/Warning Selection (Refer to 4.5.4)																																							
		0	Outputs alarm (A.830) for lowered battery voltage.																																						
1		Outputs warning (A.930) for lowered battery voltage.																																							
Function Selection for Insufficient voltage (Refer to 4.2.10)																																									
0		Disables detection of insufficient voltages.																																							
1		Detects warning and limits torque by host controller.																																							
2		Detects warning and limits torque by Pn424 and Pn425.																																							
Warning Detection Selection (Refer to 9.2.1)																																									
0	Detects warning.																																								
1	Does not detect warning.																																								
Reserved (Do not change.)																																									

(cont'd)

Parameter No.	Name	Setting Range	Units	Factory Setting	When Enabled	Classification	Reference Section		
Pn009	Application Function Select Switch 9	0000 to 0111	–	0010	After restart	Tuning	–		
	<div style="display: flex; align-items: center;"> <div style="margin-right: 10px;">n.</div> <div style="display: flex; flex-direction: column; gap: 5px;"> <div style="display: flex; align-items: center;"> <input type="checkbox"/> 4th digit </div> <div style="display: flex; align-items: center;"> <input type="checkbox"/> 3rd digit </div> <div style="display: flex; align-items: center;"> <input type="checkbox"/> 2nd digit </div> <div style="display: flex; align-items: center;"> <input type="checkbox"/> 1st digit </div> </div> </div>	Reserved (Do not change.)							
		Current Control Method Selection (Refer to 5.8.3)							
		0	Current control method 1						
		1	Current control method 2						
		Speed Detection Method Selection (Refer to 5.8.5)							
		0	Speed detection 1						
		1	Speed detection 2						
		Reserved (Do not change.)							
		Pn00B	Application Function Select Switch B	0000 to 1111	–	0000	After restart	Setup	–
<div style="display: flex; align-items: center;"> <div style="margin-right: 10px;">n.</div> <div style="display: flex; flex-direction: column; gap: 5px;"> <div style="display: flex; align-items: center;"> <input type="checkbox"/> 4th digit </div> <div style="display: flex; align-items: center;"> <input type="checkbox"/> 3rd digit </div> <div style="display: flex; align-items: center;"> <input type="checkbox"/> 2nd digit </div> <div style="display: flex; align-items: center;"> <input type="checkbox"/> 1st digit </div> </div> </div>			Parameter Display Selection (Refer to 2.3)						
	0		Setup parameters						
	1		All parameters						
	Alarm Gr.2 Stop Method Selection (Refer to 4.2.8)								
	0		Stops the motor by setting the speed reference to "0".						
	1		Same setting as Pn001.0 (Stops the motor by applying DB or by coasting)						
	Power Supply Method for Three-phase SERVOPACK (Refer to 3.1.3)								
	0		Three-phase power supply						
	1		Single-phase power supply						
	Semi-closed Encoder Usage Method								
0	Uses the encoder connected to the SERVOPACK.								
1	Uses the encoder connected to the feedback option module.								

(cont'd)

Parameter No.	Name	Setting Range	Units	Factory Setting	When Enabled	Classification	Reference Section							
Pn00C	Application Function Select Switch C	0000 to 0111	–	0000	After restart	Setup	–							
	<table border="1"> <tr> <th colspan="2">Selection of Test without Motor (Refer to 4.3.3)</th> </tr> <tr> <td>0</td> <td>Disables Test without motor.</td> </tr> <tr> <td>1</td> <td>Enables Test without motor.</td> </tr> </table>								Selection of Test without Motor (Refer to 4.3.3)		0	Disables Test without motor.	1	Enables Test without motor.
	Selection of Test without Motor (Refer to 4.3.3)													
	0	Disables Test without motor.												
	1	Enables Test without motor.												
	<table border="1"> <tr> <th colspan="2">Encoder Resolution for Test without Motor</th> </tr> <tr> <td>0</td> <td>13 bits</td> </tr> <tr> <td>1</td> <td>20 bits</td> </tr> </table>								Encoder Resolution for Test without Motor		0	13 bits	1	20 bits
	Encoder Resolution for Test without Motor													
	0	13 bits												
	1	20 bits												
<table border="1"> <tr> <th colspan="2">Encoder Type for Test without Motor (Refer to 4.3.3)</th> </tr> <tr> <td>0</td> <td>Incremental encoder</td> </tr> <tr> <td>1</td> <td>Absolute encoder</td> </tr> </table>								Encoder Type for Test without Motor (Refer to 4.3.3)		0	Incremental encoder	1	Absolute encoder	
Encoder Type for Test without Motor (Refer to 4.3.3)														
0	Incremental encoder													
1	Absolute encoder													
<table border="1"> <tr> <td colspan="2">Reserved (Do not change.)</td> </tr> </table>								Reserved (Do not change.)						
Reserved (Do not change.)														
Pn00D	Application Function Select Switch D	0000 to 0001	–	0000	After restart	Setup	–							
	<table border="1"> <tr> <th colspan="2">Stand-alone Mode (Test Operation) Selection</th> </tr> <tr> <td>0</td> <td>Enables connection with the command option module.</td> </tr> <tr> <td>1</td> <td>Disables connection with the command option module.</td> </tr> </table>								Stand-alone Mode (Test Operation) Selection		0	Enables connection with the command option module.	1	Disables connection with the command option module.
	Stand-alone Mode (Test Operation) Selection													
	0	Enables connection with the command option module.												
1	Disables connection with the command option module.													
<table border="1"> <tr> <td colspan="2">Reserved (Do not change.)</td> </tr> </table>								Reserved (Do not change.)						
Reserved (Do not change.)														
<table border="1"> <tr> <td colspan="2">Reserved (Do not change.)</td> </tr> </table>								Reserved (Do not change.)						
Reserved (Do not change.)														
<table border="1"> <tr> <td colspan="2">Reserved (Do not change.)</td> </tr> </table>								Reserved (Do not change.)						
Reserved (Do not change.)														
Pn010	Axis Address Selection	0000 to 007F	–	0001	After restart	Setup	–							
Pn081	Application Function Select Switch 81	0000 to 1111	–	0000	After restart	Setup	8.1.5							
	<table border="1"> <tr> <th colspan="2">Phase-C Pulse Output Selection</th> </tr> <tr> <td>0</td> <td>Outputs phase-C pulse only in forward direction.</td> </tr> <tr> <td>1</td> <td>Outputs phase-C pulse in forward and reverse direction.</td> </tr> </table>								Phase-C Pulse Output Selection		0	Outputs phase-C pulse only in forward direction.	1	Outputs phase-C pulse in forward and reverse direction.
	Phase-C Pulse Output Selection													
	0	Outputs phase-C pulse only in forward direction.												
1	Outputs phase-C pulse in forward and reverse direction.													
<table border="1"> <tr> <td colspan="2">Reserved (Do not change.)</td> </tr> </table>								Reserved (Do not change.)						
Reserved (Do not change.)														
<table border="1"> <tr> <td colspan="2">Reserved (Do not change.)</td> </tr> </table>								Reserved (Do not change.)						
Reserved (Do not change.)														
<table border="1"> <tr> <td colspan="2">Reserved (Do not change.)</td> </tr> </table>								Reserved (Do not change.)						
Reserved (Do not change.)														

(cont'd)

Parameter No.	Name	Setting Range	Units	Factory Setting	When Enabled	Classification	Reference Section																	
Pn100	Speed Loop Gain	10 to 20000	0.1 Hz	400	Immediately	Tuning	5.8.1																	
Pn101	Speed Loop Integral Time Constant	15 to 51200	0.01 ms	2000	Immediately	Tuning																		
Pn102	Position Loop Gain	10 to 20000	0.1/s	400	Immediately	Tuning																		
Pn103	Moment of Inertia Ratio	0 to 20000	1%	100	Immediately	Tuning																		
Pn104	2nd Speed Loop Gain	10 to 20000	0.1 Hz	400	Immediately	Tuning																		
Pn105	2nd Speed Loop Integral Time Constant	15 to 51200	0.01 ms	2000	Immediately	Tuning																		
Pn106	2nd Position Loop Gain	10 to 20000	0.1/s	400	Immediately	Tuning	5.9.1																	
Pn109	Feedforward Gain	0 to 100	1%	0	Immediately	Tuning																		
Pn10A	Feedforward Filter Time Constant	0 to 6400	0.01 ms	0	Immediately	Tuning																		
Pn10B	Application Function for Gain Select Switch	0000 to 5334	–	0000	–	–	–																	
	<table border="1"> <thead> <tr> <th colspan="2">Mode Switch Selection (Refer to 5.9.2)</th> <th>When Enabled</th> <th>Classification</th> </tr> </thead> <tbody> <tr> <td>0</td> <td>Uses internal torque reference as the condition (Level setting: Pn10C)</td> <td rowspan="4">Immediately</td> <td rowspan="4">Setup</td> </tr> <tr> <td>1</td> <td>Uses speed reference as the condition (Level setting: Pn10D)</td> </tr> <tr> <td>2</td> <td>Uses acceleration as the condition (Level setting: Pn10E)</td> </tr> <tr> <td>3</td> <td>Uses position error pulse as the condition (Level setting: Pn10F)</td> </tr> <tr> <td>4</td> <td>No mode switch function available</td> <td></td> <td></td> </tr> </tbody> </table>						Mode Switch Selection (Refer to 5.9.2)		When Enabled	Classification	0	Uses internal torque reference as the condition (Level setting: Pn10C)	Immediately	Setup	1	Uses speed reference as the condition (Level setting: Pn10D)	2	Uses acceleration as the condition (Level setting: Pn10E)	3	Uses position error pulse as the condition (Level setting: Pn10F)	4	No mode switch function available		
	Mode Switch Selection (Refer to 5.9.2)		When Enabled	Classification																				
	0	Uses internal torque reference as the condition (Level setting: Pn10C)	Immediately	Setup																				
	1	Uses speed reference as the condition (Level setting: Pn10D)																						
	2	Uses acceleration as the condition (Level setting: Pn10E)																						
	3	Uses position error pulse as the condition (Level setting: Pn10F)																						
	4	No mode switch function available																						
	<table border="1"> <thead> <tr> <th colspan="2">Speed Loop Control Method</th> <th>When Enabled</th> <th>Classification</th> </tr> </thead> <tbody> <tr> <td>0</td> <td>PI control</td> <td rowspan="3">After restart</td> <td rowspan="3">Setup</td> </tr> <tr> <td>1</td> <td>I-P control</td> </tr> <tr> <td>2 and 3</td> <td>Reserved (Do not change.)</td> </tr> </tbody> </table>						Speed Loop Control Method		When Enabled	Classification	0	PI control	After restart	Setup	1	I-P control	2 and 3	Reserved (Do not change.)						
Speed Loop Control Method		When Enabled	Classification																					
0	PI control	After restart	Setup																					
1	I-P control																							
2 and 3	Reserved (Do not change.)																							
Reserved (Do not change.)																								
Reserved (Do not change.)																								
Pn10C	Mode Switch (torque reference)	0 to 800	1%	200	Immediately	Tuning	5.9.2																	
Pn10D	Mode Switch (speed reference)	0 to 10000	1 min ⁻¹	0	Immediately	Tuning																		
Pn10E	Mode Switch (acceleration)	0 to 30000	1 min ⁻¹ /s	0	Immediately	Tuning																		
Pn10F	Mode Switch (position error pulse)	0 to 10000	1 reference unit	0	Immediately	Tuning																		
Pn11F	Position Integral Time Constant	0 to 50000	0.1 ms	0	Immediately	Tuning	5.9.4																	
Pn121	Friction Compensation Gain	10 to 1000	1%	100	Immediately	Tuning	5.8.2																	
Pn122	2nd Gain for Friction Compensation	10 to 1000	1%	100	Immediately	Tuning																		
Pn123	Friction Compensation Coefficient	0 to 100	1%	0	Immediately	Tuning																		
Pn124	Friction Compensation Frequency Correction	-10000 to 10000	0.1 Hz	0	Immediately	Tuning																		
Pn125	Friction Compensation Gain Correction	1 to 1000	1%	100	Immediately	Tuning	5.8.1																	
Pn131	Gain Switching Time 1	0 to 65535	1 ms	0	Immediately	Tuning																		
Pn132	Gain Switching Time 2	0 to 65535	1 ms	0	Immediately	Tuning																		
Pn135	Gain Switching Waiting Time 1	0 to 65535	1 ms	0	Immediately	Tuning																		
Pn136	Gain Switching Waiting Time 2	0 to 65535	1 ms	0	Immediately	Tuning																		

(cont'd)

Parameter No.	Name	Setting Range	Units	Factory Setting	When Enabled	Classification	Reference Section																																																								
Pn139	Automatic Gain Changeover Related Switch 1	0000 to 0052	–	0000	Immediately	Tuning	–																																																								
	<table border="0"> <tr> <td style="text-align: center;">4th digit</td> <td style="text-align: center;">3rd digit</td> <td style="text-align: center;">2nd digit</td> <td style="text-align: center;">1st digit</td> <td colspan="4"></td> </tr> <tr> <td style="text-align: center;">n.</td> <td style="text-align: center;"><input type="checkbox"/></td> <td style="text-align: center;"><input type="checkbox"/></td> <td style="text-align: center;"><input type="checkbox"/></td> <td style="text-align: center;"><input type="checkbox"/></td> <td colspan="3"></td> <td></td> </tr> </table>								4th digit	3rd digit	2nd digit	1st digit					n.	<input type="checkbox"/>	<input type="checkbox"/>	<input type="checkbox"/>	<input type="checkbox"/>																																										
	4th digit	3rd digit	2nd digit	1st digit																																																											
	n.	<input type="checkbox"/>	<input type="checkbox"/>	<input type="checkbox"/>	<input type="checkbox"/>																																																										
	<table border="1"> <tr> <th colspan="2">Gain Switching Selection Switch*1</th> <th colspan="6">(Refer to 5.8.1)</th> </tr> <tr> <td style="text-align: center;">0</td> <td>Manual gain switching Switches between 1st gain and 2nd gain using the gain switching reference from the command option module.</td> <td colspan="6"></td> </tr> <tr> <td style="text-align: center;">1</td> <td>Reserved (Do not change.)</td> <td colspan="6"></td> </tr> <tr> <td style="text-align: center;">2</td> <td>Automatic gain switching pattern 1 Changes automatically 1st gain to 2nd gain when the switching condition A is satisfied. Changes automatically 2nd gain to 1st gain when the switching condition A is not satisfied.</td> <td colspan="6"></td> </tr> </table>								Gain Switching Selection Switch*1		(Refer to 5.8.1)						0	Manual gain switching Switches between 1st gain and 2nd gain using the gain switching reference from the command option module.							1	Reserved (Do not change.)							2	Automatic gain switching pattern 1 Changes automatically 1st gain to 2nd gain when the switching condition A is satisfied. Changes automatically 2nd gain to 1st gain when the switching condition A is not satisfied.																													
	Gain Switching Selection Switch*1		(Refer to 5.8.1)																																																												
	0	Manual gain switching Switches between 1st gain and 2nd gain using the gain switching reference from the command option module.																																																													
	1	Reserved (Do not change.)																																																													
	2	Automatic gain switching pattern 1 Changes automatically 1st gain to 2nd gain when the switching condition A is satisfied. Changes automatically 2nd gain to 1st gain when the switching condition A is not satisfied.																																																													
	<table border="1"> <tr> <th colspan="2">Gain Switching Condition A</th> <th colspan="6">(Refer to 5.8.1)</th> </tr> <tr> <td style="text-align: center;">0</td> <td>Positioning completion signal (/COIN) ON</td> <td colspan="6"></td> </tr> <tr> <td style="text-align: center;">1</td> <td>Positioning completion signal (/COIN) OFF</td> <td colspan="6"></td> </tr> <tr> <td style="text-align: center;">2</td> <td>NEAR signal (/NEAR) ON</td> <td colspan="6"></td> </tr> <tr> <td style="text-align: center;">3</td> <td>NEAR signal (/NEAR) OFF</td> <td colspan="6"></td> </tr> <tr> <td style="text-align: center;">4</td> <td>Position reference filter output = 0 and reference input OFF</td> <td colspan="6"></td> </tr> <tr> <td style="text-align: center;">5</td> <td>Position reference input ON</td> <td colspan="6"></td> </tr> </table>								Gain Switching Condition A		(Refer to 5.8.1)						0	Positioning completion signal (/COIN) ON							1	Positioning completion signal (/COIN) OFF							2	NEAR signal (/NEAR) ON							3	NEAR signal (/NEAR) OFF							4	Position reference filter output = 0 and reference input OFF							5	Position reference input ON					
Gain Switching Condition A		(Refer to 5.8.1)																																																													
0	Positioning completion signal (/COIN) ON																																																														
1	Positioning completion signal (/COIN) OFF																																																														
2	NEAR signal (/NEAR) ON																																																														
3	NEAR signal (/NEAR) OFF																																																														
4	Position reference filter output = 0 and reference input OFF																																																														
5	Position reference input ON																																																														
Reserved (Do not change.)																																																															
Reserved (Do not change.)																																																															
Pn13D	Current Gain Level	100 to 2000	1%	2000	Immediately	Tuning	5.8.4																																																								
Pn140	Model Following Control Related Switch	0000 to 1121	–	0100	Immediately	Tuning	–																																																								
	<table border="0"> <tr> <td style="text-align: center;">4th digit</td> <td style="text-align: center;">3rd digit</td> <td style="text-align: center;">2nd digit</td> <td style="text-align: center;">1st digit</td> <td colspan="4"></td> </tr> <tr> <td style="text-align: center;">n.</td> <td style="text-align: center;"><input type="checkbox"/></td> <td style="text-align: center;"><input type="checkbox"/></td> <td style="text-align: center;"><input type="checkbox"/></td> <td style="text-align: center;"><input type="checkbox"/></td> <td colspan="3"></td> <td></td> </tr> </table>								4th digit	3rd digit	2nd digit	1st digit					n.	<input type="checkbox"/>	<input type="checkbox"/>	<input type="checkbox"/>	<input type="checkbox"/>																																										
	4th digit	3rd digit	2nd digit	1st digit																																																											
	n.	<input type="checkbox"/>	<input type="checkbox"/>	<input type="checkbox"/>	<input type="checkbox"/>																																																										
	<table border="1"> <tr> <th colspan="2">Model Following Control Selection</th> <td colspan="6"></td> </tr> <tr> <td style="text-align: center;">0</td> <td>Does not use model following control.</td> <td colspan="6"></td> </tr> <tr> <td style="text-align: center;">1</td> <td>Uses model following control.</td> <td colspan="6"></td> </tr> </table>								Model Following Control Selection								0	Does not use model following control.							1	Uses model following control.																																					
	Model Following Control Selection																																																														
	0	Does not use model following control.																																																													
	1	Uses model following control.																																																													
	<table border="1"> <tr> <th colspan="2">Vibration Suppression Selection</th> <td colspan="6"></td> </tr> <tr> <td style="text-align: center;">0</td> <td>Does not perform vibration suppression.</td> <td colspan="6"></td> </tr> <tr> <td style="text-align: center;">1</td> <td>Performs vibration suppression over the specified frequency.</td> <td colspan="6"></td> </tr> <tr> <td style="text-align: center;">2</td> <td>Performs vibration suppression over two different kinds of frequencies.</td> <td colspan="6"></td> </tr> </table>								Vibration Suppression Selection								0	Does not perform vibration suppression.							1	Performs vibration suppression over the specified frequency.							2	Performs vibration suppression over two different kinds of frequencies.																													
	Vibration Suppression Selection																																																														
0	Does not perform vibration suppression.																																																														
1	Performs vibration suppression over the specified frequency.																																																														
2	Performs vibration suppression over two different kinds of frequencies.																																																														
<table border="1"> <tr> <th colspan="2">Vibration Suppression Adjustment Selection</th> <th colspan="6">(Refer to 5.3.1, 5.4.1, 5.5.1, 5.7.1)</th> </tr> <tr> <td style="text-align: center;">0</td> <td>Does not adjust vibration suppression automatically using utility function.</td> <td colspan="6"></td> </tr> <tr> <td style="text-align: center;">1</td> <td>Adjusts vibration suppression automatically using utility function.</td> <td colspan="6"></td> </tr> </table>								Vibration Suppression Adjustment Selection		(Refer to 5.3.1, 5.4.1, 5.5.1, 5.7.1)						0	Does not adjust vibration suppression automatically using utility function.							1	Adjusts vibration suppression automatically using utility function.																																						
Vibration Suppression Adjustment Selection		(Refer to 5.3.1, 5.4.1, 5.5.1, 5.7.1)																																																													
0	Does not adjust vibration suppression automatically using utility function.																																																														
1	Adjusts vibration suppression automatically using utility function.																																																														
<table border="1"> <tr> <th colspan="2">Selection of Speed Feedforward (VFF) / Torque Feedforward (TFF)</th> <th colspan="6">(Refer to 5.3.1, 5.4.1)</th> </tr> <tr> <td style="text-align: center;">0</td> <td>Does not use model following control and speed/torque feedforward together.</td> <td colspan="6"></td> </tr> <tr> <td style="text-align: center;">1</td> <td>Uses model following control and speed/torque feedforward together.</td> <td colspan="6"></td> </tr> </table>								Selection of Speed Feedforward (VFF) / Torque Feedforward (TFF)		(Refer to 5.3.1, 5.4.1)						0	Does not use model following control and speed/torque feedforward together.							1	Uses model following control and speed/torque feedforward together.																																						
Selection of Speed Feedforward (VFF) / Torque Feedforward (TFF)		(Refer to 5.3.1, 5.4.1)																																																													
0	Does not use model following control and speed/torque feedforward together.																																																														
1	Uses model following control and speed/torque feedforward together.																																																														
Pn141	Model Following Control Gain	10 to 20000	0.1/s	500	Immediately	Tuning	–																																																								
Pn142	Model Following Control Gain Compensation	500 to 2000	0.1%	1000	Immediately	Tuning	–																																																								

*1. For details on this function, refer to the manual of the connected command option module.

(cont'd)

Parameter No.	Name	Setting Range	Units	Factory Setting	When Enabled	Classification	Reference Section						
Pn143	Model Following Control Bias (Forward Direction)	0 to 10000	0.1%	1000	Immediately	Tuning	–						
Pn144	Model Following Control Bias (Reverse Direction)	0 to 10000	0.1%	1000	Immediately	Tuning	–						
Pn145	Vibration Suppression 1 Frequency A	10 to 2500	0.1 Hz	500	Immediately	Tuning	–						
Pn146	Vibration Suppression 1 Frequency B	10 to 2500	0.1 Hz	700	Immediately	Tuning	–						
Pn147	Model Following Control Speed Feedforward Compensation	0 to 10000	0.1%	1000	Immediately	Tuning	–						
Pn148	2nd Model Following Control Gain	10 to 20000	0.1/s	500	Immediately	Tuning	–						
Pn149	2nd Model Following Control Gain Compensation	500 to 2000	0.1%	1000	Immediately	Tuning	–						
Pn14A	Vibration Suppression 2 Frequency	10 to 2000	0.1 Hz	800	Immediately	Tuning	–						
Pn14B	Vibration Suppression 2 Compensation	10 to 1000	1%	100	Immediately	Tuning	–						
Pn14F	Reserved Parameter (Do not change.)	–	–	0011	–	–	–						
Pn160	Anti-Resonance Control Related Switch	0000 to 0011	–	0010	After restart	Tuning	–						
	<p>4th digit 3rd digit 2nd digit 1st digit</p> <p>n. <input type="checkbox"/> <input type="checkbox"/> <input type="checkbox"/> <input type="checkbox"/></p>												
	<table border="1"> <thead> <tr> <th colspan="2">Anti-Resonance Control Selection (Refer to 5.3.1, 5.4.1, 5.5.1, 5.7.1)</th> </tr> </thead> <tbody> <tr> <td>0</td> <td>Does not use anti-resonance control.</td> </tr> <tr> <td>1</td> <td>Uses anti-resonance control.</td> </tr> </tbody> </table>							Anti-Resonance Control Selection (Refer to 5.3.1, 5.4.1, 5.5.1, 5.7.1)		0	Does not use anti-resonance control.	1	Uses anti-resonance control.
	Anti-Resonance Control Selection (Refer to 5.3.1, 5.4.1, 5.5.1, 5.7.1)												
	0	Does not use anti-resonance control.											
	1	Uses anti-resonance control.											
<table border="1"> <thead> <tr> <th colspan="2">Anti-Resonance Control Adjustment Selection (Refer to 5.3.1, 5.4.1, 5.5.1, 5.7.1)</th> </tr> </thead> <tbody> <tr> <td>0</td> <td>Does not use adjust anti-resonance control automatically using utility function.</td> </tr> <tr> <td>1</td> <td>Adjusts anti-resonance control automatically using utility function.</td> </tr> </tbody> </table>							Anti-Resonance Control Adjustment Selection (Refer to 5.3.1, 5.4.1, 5.5.1, 5.7.1)		0	Does not use adjust anti-resonance control automatically using utility function.	1	Adjusts anti-resonance control automatically using utility function.	
Anti-Resonance Control Adjustment Selection (Refer to 5.3.1, 5.4.1, 5.5.1, 5.7.1)													
0	Does not use adjust anti-resonance control automatically using utility function.												
1	Adjusts anti-resonance control automatically using utility function.												
Reserved (Do not change.)													
Reserved (Do not change.)													
Pn161	Anti-Resonance Frequency	10 to 20000	0.1 Hz	1000	Immediately	Tuning	–						
Pn162	Anti-Resonance Gain Compensation	1 to 1000	1%	100	Immediately	Tuning	–						
Pn163	Anti-Resonance Damping Gain	0 to 300	1%	0	Immediately	Tuning	–						
Pn164	Anti-Resonance Filter Time Constant 1 Compensation	-1000 to 1000	0.01 ms	0	Immediately	Tuning	–						
Pn165	Anti-Resonance Filter Time Constant 2 Compensation	-1000 to 1000	0.01 ms	0	Immediately	Tuning	–						

(cont'd)

Parameter No.	Name	Setting Range	Units	Factory Setting	When Enabled	Classification	Reference Section
Pn170	Tuning-less Function Related Switch	0000 to 2411	–	1401	–	–	–
	<div style="display: flex; align-items: center;"> <div style="margin-right: 10px;">n.</div> <div style="display: flex; flex-direction: column; gap: 5px;"> <div style="display: flex; align-items: center;">4th digit <input type="checkbox"/></div> <div style="display: flex; align-items: center;">3rd digit <input type="checkbox"/></div> <div style="display: flex; align-items: center;">2nd digit <input type="checkbox"/></div> <div style="display: flex; align-items: center;">1st digit <input type="checkbox"/></div> </div> </div>	Tuning-less Function Selection (Refer to 5.2)		When Enabled	Classification		
		0	Tuning-less function disabled	After restart	Setup		
		1	Tuning-less function enabled				
		Control Method during Speed Control (Refer to 5.2)		When Enabled	Classification		
	0	Uses as speed control.	After restart	Setup			
	1	Uses as speed control and uses the host controller for position control.					
	Tuning-less Tuning Level (Refer to 5.2)		When Enabled	Classification			
	0 to 4	Sets tuning-less tuning level.	Immediately	Setup			
	Tuning-less Load Level (Refer to 5.2)		When Enabled	Classification			
0 to 2	Sets tuning-less load level.	Immediately	Setup				
Pn190	Reserved Parameter (Do not change.)	–	–	0010	–	–	–
Pn200	Reserved Parameter (Do not change.)	–	–	0100	–	–	–
Pn205	Multiturn Limit	0 to 65535	1 rev	65535	After restart	Setup	4.5.6
Pn207	Position Control Function Switch	0000 to 2210	–	0010	After restart	Setup	–
	<div style="display: flex; align-items: center;"> <div style="margin-right: 10px;">n.</div> <div style="display: flex; flex-direction: column; gap: 5px;"> <div style="display: flex; align-items: center;">4th digit <input type="checkbox"/></div> <div style="display: flex; align-items: center;">3rd digit <input type="checkbox"/></div> <div style="display: flex; align-items: center;">2nd digit <input type="checkbox"/></div> <div style="display: flex; align-items: center;">1st digit <input type="checkbox"/></div> </div> </div>	Reserved (Do not change.)					
		Reserved (Do not change.)					
		Reserved (Do not change.)					
		COIN Output Timing					
	0	Outputs when the position error absolute value is the same or less than the positioning completion width (Pn522).					
1	Outputs when the position error absolute value is the position completion width (Pn522) or less and the reference after position reference filtering is 0.						
2	When the absolute value of the position error is below the positioning completed width setting (Pn522), and the position reference input is 0.						
Pn20A	Number of External Encoder Pitch	4 to 1048576	1 pitch/rev	32768	After restart	Setup	8.3
Pn20E	Electronic Gear Ratio (Numerator)	1 to 1073741824	1	4	After restart	Setup	4.2.4
Pn210	Electronic Gear Ratio (Denominator)	1 to 1073741824	1	1	After restart	Setup	
Pn212	Encoder Output Pulses	16 to 1073741824	1 P/rev	2048	After restart	Setup	–

(cont'd)

Parameter No.	Name	Setting Range	Units	Factory Setting	When Enabled	Classification	Reference Section						
Pn216	Reserved Parameter (Do not change.)	–	–	0	–	–	–						
Pn217	Reserved Parameter (Do not change.)	–	–	0	–	–	–						
Pn22A	Fully-closed Control Selection Switch	0000 to 1003	–	0000	After restart	Setup	–						
	Reserved (Do not change.)												
	Reserved (Do not change.)												
	Reserved (Do not change.)												
<table border="1"> <thead> <tr> <th colspan="2">Speed Feedback Selection at Fully-closed Control (Refer to 8.3.8)</th> </tr> </thead> <tbody> <tr> <td>0</td> <td>Uses motor encoder speed.</td> </tr> <tr> <td>1</td> <td>Uses external encoder speed.</td> </tr> </tbody> </table>							Speed Feedback Selection at Fully-closed Control (Refer to 8.3.8)		0	Uses motor encoder speed.	1	Uses external encoder speed.	
Speed Feedback Selection at Fully-closed Control (Refer to 8.3.8)													
0	Uses motor encoder speed.												
1	Uses external encoder speed.												
Pn281	Encoder Output Resolution	1 to 4096	1 edge/ pitch	20	After restart	Setup	8.3.4						
Pn300	Reserved Parameter (Do not change.)	–	–	600	–	–	–						
Pn301	Reserved Parameter (Do not change.)	–	–	100	–	–	–						
Pn302	Reserved Parameter (Do not change.)	–	–	200	–	–	–						
Pn303	Reserved Parameter (Do not change.)	–	–	300	–	–	–						
Pn304	JOG Speed	0 to 10000	1 min ⁻¹	500	Immediately	Setup	6.3						
Pn305	Soft Start Acceleration Time	0 to 10000	1 ms	0	Immediately	Setup	–						
Pn306	Soft Start Deceleration Time	0 to 10000	1 ms	0	Immediately	Setup							
Pn307	Reserved Parameter (Do not change.)	–	–	40	–	–	–						
Pn310	Vibration Detection Switch	0000 to 0002	–	0000	Immediately	Setup	–						
	Vibration Detection Selection (Refer to 6.16)												
	<table border="1"> <tbody> <tr> <td>0</td> <td>No detection.</td> </tr> <tr> <td>1</td> <td>Outputs warning (A.911) when vibration is detected.</td> </tr> <tr> <td>2</td> <td>Outputs alarm (A.520) when vibration is detected.</td> </tr> </tbody> </table>							0	No detection.	1	Outputs warning (A.911) when vibration is detected.	2	Outputs alarm (A.520) when vibration is detected.
	0	No detection.											
1	Outputs warning (A.911) when vibration is detected.												
2	Outputs alarm (A.520) when vibration is detected.												
Reserved (Do not change.)													
Reserved (Do not change.)													
Pn311	Vibration Detection Sensibility	50 to 500	1%	100	Immediately	Tuning	6.16						
Pn312	Vibration Detection Level	0 to 5000	1 min ⁻¹	50	Immediately	Tuning							

(cont'd)

Parameter No.	Name	Setting Range	Units	Factory Setting	When Enabled	Classification	Reference Section		
Pn324	Moment of Inertia Calculating Start Level	0 to 20000	1%	300	Immediately	Setup	5.3.2		
Pn400	Reserved Parameter (Do not change.)	–	–	30	–	–	–		
Pn401	1st Step 1st Torque Reference Filter Time Constant	0 to 65535	0.01 ms	100	Immediately	Tuning	5.9.3		
Pn402	Forward Torque Limit	0 to 800	1%	800	Immediately	Setup	–		
Pn403	Reverse Torque Limit	0 to 800	1%	800	Immediately	Setup			
Pn404	Forward External Torque Limit	0 to 800	1%	100	Immediately	Setup	–		
Pn405	Reverse External Torque Limit	0 to 800	1%	100	Immediately	Setup			
Pn406	Emergency Stop Torque	0 to 800	1%	800	Immediately	Setup	4.2.3		
Pn407	Speed Limit during Torque Control	0 to 10000	1 min ⁻¹	10000	Immediately	Setup	–		
Pn408	Torque Related Function Switch	0000 to 1111	–	0000	–	Setup	–		
	<div style="display: flex; align-items: center;"> <div style="margin-right: 10px;"> 4th digit n. <input type="checkbox"/> </div> <div style="margin-right: 10px;"> 3rd digit <input type="checkbox"/> </div> <div style="margin-right: 10px;"> 2nd digit <input type="checkbox"/> </div> <div style="margin-right: 10px;"> 1st digit <input type="checkbox"/> </div> </div>								
	1st Step Notch Filter Selection (Refer to 5.9.3)						When Enabled	Classification	
	0						N/A	Immediately	Setup
	1						Uses 1st step notch filter for torque reference.		
	Speed Limit Selection						When Enabled	Classification	
	0						Uses the smaller value between motor max. speed and parameter Pn407 as speed limit value.	After restart	Setup
	1						Uses the smaller value between overspeed detection speed and parameter Pn407 as speed limit value.		
	2nd Step Notch Filter Selection (Refer to 5.9.3)						When Enabled	Classification	
	0						N/A	Immediately	Setup
	1						Uses 2nd step notch filter for torque reference.		
	Friction Compensation Function Selection (Refer to 5.8.2)						When Enabled	Classification	
0						Disables use friction compensation function.	Immediately	Setup	
1						Enables friction compensation function.			
Pn409	1st Notch Filter Frequency	50 to 5000	1 Hz	5000	Immediately	Tuning	5.9.3		
Pn40A	1st Notch Filter Q Value	50 to 1000	0.01	70	Immediately	Tuning			
Pn40B	1st Notch Filter Depth	0 to 1000	0.001	0	Immediately	Tuning			
Pn40C	2nd Notch Filter Frequency	50 to 5000	1 Hz	5000	Immediately	Tuning			
Pn40D	2nd Notch Filter Q Value	50 to 1000	0.01	70	Immediately	Tuning			
Pn40E	2nd Notch Filter Depth	0 to 1000	0.001	0	Immediately	Tuning			
Pn40F	2nd Step 2nd Torque Reference Filter Frequency	100 to 5000	1 Hz	5000	Immediately	Tuning			
Pn410	2nd Step 2nd Torque Reference Filter Q Value	50 to 100	0.01	50	Immediately	Tuning			
Pn412	1st Step 2nd Torque Reference Filter Time Constant	0 to 65535	0.01 ms	100	Immediately	Tuning			

(cont'd)

Parameter No.	Name	Setting Range	Units	Factory Setting	When Enabled	Classification	Reference Section															
Pn423	Reserved Parameter (Do not change.)	–	–	0000	–	–	–															
Pn424	Torque Limit at Main Circuit Voltage Drop	0 to 100	1%	50	Immediately	Setup	4.2.10															
Pn425	Release Time for Torque Limit at Main Circuit Voltage Drop	0 to 1000	1 ms	100	Immediately	Setup																
Pn456	Sweep Torque Reference Amplitude	1 to 800	1%	15	Immediately	Tuning	6.19															
Pn460	Notch Filter Adjustment Switch	0000 to 0101	–	0101	Immediately	Tuning	5.2.1 5.3.1 5.5.1															
	<p>4th digit 3rd digit 2nd digit 1st digit</p> <p>n. <input type="checkbox"/> <input type="checkbox"/> <input type="checkbox"/> <input type="checkbox"/></p> <table border="1"> <tr> <td colspan="2">Notch Filter Adjustment Selection 1</td> </tr> <tr> <td>0</td> <td>1st step notch filter is not adjusted automatically with utility function.</td> </tr> <tr> <td>1</td> <td>1st step notch filter is adjusted automatically with utility function.</td> </tr> <tr> <td colspan="2">Reserved (Do not change.)</td> </tr> <tr> <td colspan="2">Notch Filter Adjustment Selection 2</td> </tr> <tr> <td>0</td> <td>2nd step notch filter is not adjusted automatically with utility function.</td> </tr> <tr> <td>1</td> <td>2nd step notch filter is adjusted automatically with utility function.</td> </tr> <tr> <td colspan="2">Reserved (Do not change.)</td> </tr> </table>							Notch Filter Adjustment Selection 1		0	1st step notch filter is not adjusted automatically with utility function.	1	1st step notch filter is adjusted automatically with utility function.	Reserved (Do not change.)		Notch Filter Adjustment Selection 2		0	2nd step notch filter is not adjusted automatically with utility function.	1	2nd step notch filter is adjusted automatically with utility function.	Reserved (Do not change.)
Notch Filter Adjustment Selection 1																						
0	1st step notch filter is not adjusted automatically with utility function.																					
1	1st step notch filter is adjusted automatically with utility function.																					
Reserved (Do not change.)																						
Notch Filter Adjustment Selection 2																						
0	2nd step notch filter is not adjusted automatically with utility function.																					
1	2nd step notch filter is adjusted automatically with utility function.																					
Reserved (Do not change.)																						
Pn501	Reserved Parameter (Do not change.)	–	–	10	–	–	–															
Pn502	Rotation Detection Level	1 to 10000	1 min ⁻¹	20	Immediately	Setup	–															
Pn503	Speed Coincidence Signal Output Width	0 to 100	1 min ⁻¹	10	Immediately	Setup	–															
Pn506	Brake Reference - Servo OFF Delay Time	0 to 50	10 ms	0	Immediately	Setup	4.2.7															
Pn507	Brake Reference Output Speed Level	0 to 10000	1 min ⁻¹	100	Immediately	Setup																
Pn508	Waiting Time for Brake Signal When Motor Running	10 to 100	10 ms	50	Immediately	Setup																
Pn509	Instantaneous Power Cut Hold time	20 to 1000	1 ms	20	Immediately	Setup	4.2.9															

(cont'd)

Parameter No.	Name	Setting Range	Units	Factory Setting	When Enabled	Classification	Reference Section																																
Pn50A	Input Signal Selection 1	0000 to FFF1	—	1881	After restart	Setup	—																																
	<div style="display: flex; justify-content: space-around; align-items: center;"> <div style="text-align: center;"> <p>4th digit</p> <input type="checkbox"/> </div> <div style="text-align: center;"> <p>3rd digit</p> <input type="checkbox"/> </div> <div style="text-align: center;"> <p>2nd digit</p> <input type="checkbox"/> </div> <div style="text-align: center;"> <p>1st digit</p> <input type="checkbox"/> </div> </div> <p>n.</p> <div style="margin-top: 10px;"> <div style="border: 1px solid black; background-color: #cccccc; padding: 2px; margin-bottom: 5px;">Reserved (Do not change.)</div> <div style="border: 1px solid black; background-color: #cccccc; padding: 2px; margin-bottom: 5px;">Reserved (Do not change.)</div> <div style="border: 1px solid black; background-color: #cccccc; padding: 2px; margin-bottom: 5px;">Reserved (Do not change.)</div> <div style="border: 1px solid black; background-color: #cccccc; padding: 2px; margin-bottom: 5px;">P-OT Signal Mapping (Refer to 4.2.3)</div> <table border="1" style="width: 100%; border-collapse: collapse;"> <tr><td style="text-align: center;">0</td><td>Forward run allowed when CN1-13 input signal is ON (L-level)</td></tr> <tr><td style="text-align: center;">1</td><td>Forward run allowed when CN1-7 input signal is ON (L-level)</td></tr> <tr><td style="text-align: center;">2</td><td>Forward run allowed when CN1-8 input signal is ON (L-level)</td></tr> <tr><td style="text-align: center;">3</td><td>Forward run allowed when CN1-9 input signal is ON (L-level)</td></tr> <tr><td style="text-align: center;">4</td><td>Forward run allowed when CN1-10 input signal is ON (L-level)</td></tr> <tr><td style="text-align: center;">5</td><td>Forward run allowed when CN1-11 input signal is ON (L-level)</td></tr> <tr><td style="text-align: center;">6</td><td>Forward run allowed when CN1-12 input signal is ON (L-level)</td></tr> <tr><td style="text-align: center;">7</td><td>Forward run prohibited</td></tr> <tr><td style="text-align: center;">8</td><td>Forward run allowed</td></tr> <tr><td style="text-align: center;">9</td><td>Forward run allowed when CN1-13 input signal is OFF (H-level)</td></tr> <tr><td style="text-align: center;">A</td><td>Forward run allowed when CN1-7 input signal is OFF (H-level)</td></tr> <tr><td style="text-align: center;">B</td><td>Forward run allowed when CN1-8 input signal is OFF (H-level)</td></tr> <tr><td style="text-align: center;">C</td><td>Forward run allowed when CN1-9 input signal is OFF (H-level)</td></tr> <tr><td style="text-align: center;">D</td><td>Forward run allowed when CN1-10 input signal is OFF (H-level)</td></tr> <tr><td style="text-align: center;">E</td><td>Forward run allowed when CN1-11 input signal is OFF (H-level)</td></tr> <tr><td style="text-align: center;">F</td><td>Forward run allowed when CN1-12 input signal is OFF (H-level)</td></tr> </table> </div>	0	Forward run allowed when CN1-13 input signal is ON (L-level)	1	Forward run allowed when CN1-7 input signal is ON (L-level)	2	Forward run allowed when CN1-8 input signal is ON (L-level)	3	Forward run allowed when CN1-9 input signal is ON (L-level)	4	Forward run allowed when CN1-10 input signal is ON (L-level)	5	Forward run allowed when CN1-11 input signal is ON (L-level)	6	Forward run allowed when CN1-12 input signal is ON (L-level)	7	Forward run prohibited	8	Forward run allowed	9	Forward run allowed when CN1-13 input signal is OFF (H-level)	A	Forward run allowed when CN1-7 input signal is OFF (H-level)	B	Forward run allowed when CN1-8 input signal is OFF (H-level)	C	Forward run allowed when CN1-9 input signal is OFF (H-level)	D	Forward run allowed when CN1-10 input signal is OFF (H-level)	E	Forward run allowed when CN1-11 input signal is OFF (H-level)	F	Forward run allowed when CN1-12 input signal is OFF (H-level)						
	0	Forward run allowed when CN1-13 input signal is ON (L-level)																																					
	1	Forward run allowed when CN1-7 input signal is ON (L-level)																																					
	2	Forward run allowed when CN1-8 input signal is ON (L-level)																																					
	3	Forward run allowed when CN1-9 input signal is ON (L-level)																																					
	4	Forward run allowed when CN1-10 input signal is ON (L-level)																																					
	5	Forward run allowed when CN1-11 input signal is ON (L-level)																																					
	6	Forward run allowed when CN1-12 input signal is ON (L-level)																																					
	7	Forward run prohibited																																					
	8	Forward run allowed																																					
	9	Forward run allowed when CN1-13 input signal is OFF (H-level)																																					
	A	Forward run allowed when CN1-7 input signal is OFF (H-level)																																					
	B	Forward run allowed when CN1-8 input signal is OFF (H-level)																																					
	C	Forward run allowed when CN1-9 input signal is OFF (H-level)																																					
	D	Forward run allowed when CN1-10 input signal is OFF (H-level)																																					
	E	Forward run allowed when CN1-11 input signal is OFF (H-level)																																					
	F	Forward run allowed when CN1-12 input signal is OFF (H-level)																																					

(cont'd)

Parameter No.	Name	Setting Range	Units	Factory Setting	When Enabled	Classification	Reference Section	
Pn50B	Input Signal Selection 2	0000 to FFFF	–	8882	After restart	Setup	–	
	<div style="display: flex; justify-content: space-around; margin-bottom: 5px;"> 4th digit 3rd digit 2nd digit 1st digit </div> <div style="display: flex; align-items: center;"> n. <input style="width: 20px; height: 20px; margin-right: 5px;" type="checkbox"/> <input style="width: 20px; height: 20px; margin-right: 5px;" type="checkbox"/> <input style="width: 20px; height: 20px; margin-right: 5px;" type="checkbox"/> <input style="width: 20px; height: 20px;" type="checkbox"/> </div>							
	N-OT Signal Mapping (Refer to 4.2.3)							
	0		Reverse run allowed when CN1-13 input signal is ON (L-level).					
	1		Reverse run allowed when CN1-7 input signal is ON (L-level).					
	2		Reverse run allowed when CN1-8 input signal is ON (L-level).					
	3		Reverse run allowed when CN1-9 input signal is ON (L-level) .					
	4		Reverse run allowed when CN1-10 input signal is ON (L-level).					
	5		Reverse run allowed when CN1-11 input signal is ON (L-level).					
	6		Reverse run allowed when CN1-12 input signal is ON (L-level).					
	7		Reverse run prohibited.					
	8		Reverse run allowed.					
	9		Reverse run allowed when CN1-13 input signal is OFF (H-level).					
	A		Reverse run allowed when CN1-7 input signal is OFF (H-level).					
	B		Reverse run allowed when CN1-8 input signal is OFF (H-level).					
C		Reverse run allowed when CN1-9 input signal is OFF (H-level).						
D		Reverse run allowed when CN1-10 input signal is OFF (H-level).						
E		Reverse run allowed when CN1-11 input signal is OFF (H-level).						
F		Reverse run allowed when CN1-12 input signal is OFF (H-level).						
Reserved (Do not change.)								
/P-CL Signal Mapping								
0		ON when CN1-13 input signal is ON (L-level)						
1		ON when CN1-7 input signal is ON (L-level)						
2		ON when CN1-8 input signal is ON (L-level)						
3		ON when CN1-9 input signal is ON (L-level)						
4		ON when CN1-10 input signal is ON (L-level)						
5		ON when CN1-11 input signal is ON (L-level)						
6		ON when CN1-12 input signal is ON (L-level)						
7		Sets signal ON.						
8		Sets signal OFF.						
9		OFF when CN1-13 input signal is OFF (H-level)						
A		OFF when CN1-7 input signal is OFF (H-level)						
B		OFF when CN1-8 input signal is OFF (H-level)						
C		OFF when CN1-9 input signal is OFF (H-level)						
D		OFF when CN1-10 input signal is OFF (H-level)						
E		OFF when CN1-11 input signal is OFF (H-level)						
F		OFF when CN1-12 input signal is OFF (H-level)						
/N-CL Signal Mapping								
0 to F		Same as /P-CL signal mapping						

(cont'd)

Parameter No.	Name	Setting Range	Units	Factory Setting	When Enabled	Classification	Reference Section																
Pn50E	Output Signal Selection 1	0000 to 3333	–	0000	After restart	Setup	3.3.2																
	<div style="display: flex; align-items: flex-start;"> <div style="margin-right: 10px;"> 4th digit <input type="checkbox"/> 3rd digit <input type="checkbox"/> 2nd digit <input type="checkbox"/> 1st digit <input type="checkbox"/> </div> <div style="margin-right: 10px;"> n. </div> <div style="border-left: 1px solid black; padding-left: 10px;"> <table border="1" style="width: 100%; border-collapse: collapse;"> <tr> <td colspan="2" style="background-color: #cccccc;">Positioning Completion Signal Mapping (/COIN)</td> </tr> <tr> <td style="width: 50px; text-align: center;">0</td> <td>Disabled (the above signal is not used.)</td> </tr> <tr> <td style="text-align: center;">1</td> <td>Outputs the signal from CN1-1, 2 output terminal.</td> </tr> <tr> <td style="text-align: center;">2</td> <td>Outputs the signal from CN1-23, 24 output terminal.</td> </tr> <tr> <td style="text-align: center;">3</td> <td>Outputs the signal from CN1-25, 26 output terminal.</td> </tr> <tr> <td colspan="2" style="background-color: #cccccc;">Speed Coincidence Detection Signal Mapping (/V-CMP)</td> </tr> <tr> <td style="text-align: center;">0 to 3</td> <td>Same as /COIN</td> </tr> <tr> <td colspan="2" style="background-color: #cccccc;">Servomotor Rotation Detection Signal Mapping (/TGON)</td> </tr> <tr> <td style="text-align: center;">0 to 3</td> <td>Same as /COIN</td> </tr> <tr> <td colspan="2" style="background-color: #cccccc;">Servo Ready Signal Mapping (/S-RDY)</td> </tr> <tr> <td style="text-align: center;">0 to 3</td> <td>Same as /COIN</td> </tr> </table> </div> </div>	Positioning Completion Signal Mapping (/COIN)		0	Disabled (the above signal is not used.)	1	Outputs the signal from CN1-1, 2 output terminal.	2	Outputs the signal from CN1-23, 24 output terminal.	3	Outputs the signal from CN1-25, 26 output terminal.	Speed Coincidence Detection Signal Mapping (/V-CMP)		0 to 3	Same as /COIN	Servomotor Rotation Detection Signal Mapping (/TGON)		0 to 3	Same as /COIN	Servo Ready Signal Mapping (/S-RDY)		0 to 3	Same as /COIN
		Positioning Completion Signal Mapping (/COIN)																					
		0	Disabled (the above signal is not used.)																				
		1	Outputs the signal from CN1-1, 2 output terminal.																				
		2	Outputs the signal from CN1-23, 24 output terminal.																				
		3	Outputs the signal from CN1-25, 26 output terminal.																				
		Speed Coincidence Detection Signal Mapping (/V-CMP)																					
		0 to 3	Same as /COIN																				
		Servomotor Rotation Detection Signal Mapping (/TGON)																					
0 to 3		Same as /COIN																					
Servo Ready Signal Mapping (/S-RDY)																							
0 to 3	Same as /COIN																						
Pn50F	Output Signal Selection 2	0000 to 3333	–	0100	After restart	Setup	3.3.2																
	<div style="display: flex; align-items: flex-start;"> <div style="margin-right: 10px;"> 4th digit <input type="checkbox"/> 3rd digit <input type="checkbox"/> 2nd digit <input type="checkbox"/> 1st digit <input type="checkbox"/> </div> <div style="margin-right: 10px;"> n. </div> <div style="border-left: 1px solid black; padding-left: 10px;"> <table border="1" style="width: 100%; border-collapse: collapse;"> <tr> <td colspan="2" style="background-color: #cccccc;">Torque Limit Detection Signal Mapping (/CLT)</td> </tr> <tr> <td style="width: 50px; text-align: center;">0</td> <td>Disabled (the above signal is not used.)</td> </tr> <tr> <td style="text-align: center;">1</td> <td>Outputs the signal from CN1-1, 2 output terminal.</td> </tr> <tr> <td style="text-align: center;">2</td> <td>Outputs the signal from CN1-23, 24 output terminal.</td> </tr> <tr> <td style="text-align: center;">3</td> <td>Outputs the signal from CN1-25, 26 output terminal.</td> </tr> <tr> <td colspan="2" style="background-color: #cccccc;">Speed Limit Detection Signal Mapping (/VLT)</td> </tr> <tr> <td style="text-align: center;">0 to 3</td> <td>Same as /CLT</td> </tr> <tr> <td colspan="2" style="background-color: #cccccc;">Brake Signal Mapping (/BK)</td> </tr> <tr> <td style="text-align: center;">0 to 3</td> <td>Same as /CLT</td> </tr> <tr> <td colspan="2" style="background-color: #cccccc;">Warning Signal Mapping (/WARN)</td> </tr> <tr> <td style="text-align: center;">0 to 3</td> <td>Same as /CLT</td> </tr> </table> </div> </div>	Torque Limit Detection Signal Mapping (/CLT)		0	Disabled (the above signal is not used.)	1	Outputs the signal from CN1-1, 2 output terminal.	2	Outputs the signal from CN1-23, 24 output terminal.	3	Outputs the signal from CN1-25, 26 output terminal.	Speed Limit Detection Signal Mapping (/VLT)		0 to 3	Same as /CLT	Brake Signal Mapping (/BK)		0 to 3	Same as /CLT	Warning Signal Mapping (/WARN)		0 to 3	Same as /CLT
		Torque Limit Detection Signal Mapping (/CLT)																					
		0	Disabled (the above signal is not used.)																				
		1	Outputs the signal from CN1-1, 2 output terminal.																				
		2	Outputs the signal from CN1-23, 24 output terminal.																				
		3	Outputs the signal from CN1-25, 26 output terminal.																				
		Speed Limit Detection Signal Mapping (/VLT)																					
		0 to 3	Same as /CLT																				
		Brake Signal Mapping (/BK)																					
0 to 3		Same as /CLT																					
Warning Signal Mapping (/WARN)																							
0 to 3	Same as /CLT																						

(cont'd)

Parameter No.	Name	Setting Range	Units	Factory Setting	When Enabled	Classification	Reference Section																																																																																	
Pn510	Output Signal Selection 3	0000 to 0033	–	0000	After restart	Setup	–																																																																																	
	<table border="0" style="width: 100%;"> <tr> <td style="width: 5%;"></td> <td style="width: 5%; text-align: center;">4th digit</td> <td style="width: 5%; text-align: center;">3rd digit</td> <td style="width: 5%; text-align: center;">2nd digit</td> <td style="width: 5%; text-align: center;">1st digit</td> <td colspan="3"></td> </tr> <tr> <td>n.</td> <td style="text-align: center;">□</td> <td style="text-align: center;">□</td> <td style="text-align: center;">□</td> <td style="text-align: center;">□</td> <td colspan="3"></td> </tr> <tr> <td></td> <td colspan="4" style="border: none;"></td> <td style="border: none;"></td> <td colspan="2" style="border: none;">Near Signal Mapping (NEAR)</td> </tr> <tr> <td></td> <td colspan="4" style="border: none;"></td> <td style="border: none; text-align: center;">0</td> <td colspan="2" style="border: none;">Disabled (the above signal is not used.)</td> </tr> <tr> <td></td> <td colspan="4" style="border: none;"></td> <td style="border: none; text-align: center;">1</td> <td colspan="2" style="border: none;">Outputs the signal from CN1-1, -2 terminal.</td> </tr> <tr> <td></td> <td colspan="4" style="border: none;"></td> <td style="border: none; text-align: center;">2</td> <td colspan="2" style="border: none;">Outputs the signal from CN1-23, -24 terminal.</td> </tr> <tr> <td></td> <td colspan="4" style="border: none;"></td> <td style="border: none; text-align: center;">3</td> <td colspan="2" style="border: none;">Outputs the signal from CN1-25, -26 terminal.</td> </tr> <tr> <td></td> <td colspan="4" style="border: none;"></td> <td colspan="3" style="border: none;">Reserved (Do not change.)</td> </tr> <tr> <td></td> <td colspan="4" style="border: none;"></td> <td colspan="3" style="border: none;">Reserved (Do not change.)</td> </tr> <tr> <td></td> <td colspan="4" style="border: none;"></td> <td colspan="3" style="border: none;">Reserved (Do not change.)</td> </tr> </table>									4th digit	3rd digit	2nd digit	1st digit				n.	□	□	□	□										Near Signal Mapping (NEAR)							0	Disabled (the above signal is not used.)							1	Outputs the signal from CN1-1, -2 terminal.							2	Outputs the signal from CN1-23, -24 terminal.							3	Outputs the signal from CN1-25, -26 terminal.							Reserved (Do not change.)								Reserved (Do not change.)								Reserved (Do not change.)		
		4th digit	3rd digit	2nd digit	1st digit																																																																																			
	n.	□	□	□	□																																																																																			
							Near Signal Mapping (NEAR)																																																																																	
						0	Disabled (the above signal is not used.)																																																																																	
						1	Outputs the signal from CN1-1, -2 terminal.																																																																																	
						2	Outputs the signal from CN1-23, -24 terminal.																																																																																	
						3	Outputs the signal from CN1-25, -26 terminal.																																																																																	
						Reserved (Do not change.)																																																																																		
					Reserved (Do not change.)																																																																																			
					Reserved (Do not change.)																																																																																			

(cont'd)

Parameter No.	Name	Setting Range	Units	Factory Setting	When Enabled	Classification	Reference Section																																		
Pn511	Input Signal Selection 5	0000 to FFFF	–	6543	After restart	Setup	–																																		
	<div style="display: flex; align-items: center;"> <div style="margin-right: 10px;">n.</div> <div style="display: flex; gap: 10px;"> <div style="text-align: center;">4th digit <input type="checkbox"/></div> <div style="text-align: center;">3rd digit <input type="checkbox"/></div> <div style="text-align: center;">2nd digit <input type="checkbox"/></div> <div style="text-align: center;">1st digit <input type="checkbox"/></div> </div> </div>																																								
	<table border="1" style="width: 100%; border-collapse: collapse;"> <thead> <tr> <th colspan="2" style="background-color: #cccccc;">Input Signal 3 Mapping for Command Option Module (/SI3)</th> </tr> </thead> <tbody> <tr><td style="text-align: center;">0</td><td>Inputs the signal from CN1-13 input terminal.</td></tr> <tr><td style="text-align: center;">1</td><td>Inputs the signal from CN1-7 input terminal.</td></tr> <tr><td style="text-align: center;">2</td><td>Inputs the signal from CN1-8 input terminal.</td></tr> <tr><td style="text-align: center;">3</td><td>Inputs the signal from CN1-9 input terminal.</td></tr> <tr><td style="text-align: center;">4</td><td>Inputs the signal from CN1-10 input terminal.</td></tr> <tr><td style="text-align: center;">5</td><td>Inputs the signal from CN1-11 input terminal.</td></tr> <tr><td style="text-align: center;">6</td><td>Inputs the signal from CN1-12 input terminal.</td></tr> <tr><td style="text-align: center;">7</td><td>Sets signal ON.</td></tr> <tr><td style="text-align: center;">8</td><td>Sets signal OFF.</td></tr> <tr><td style="text-align: center;">9</td><td>Inputs the reverse signal from CN1-13 input terminal.</td></tr> <tr><td style="text-align: center;">A</td><td>Inputs the reverse signal from CN1-7 input terminal.</td></tr> <tr><td style="text-align: center;">B</td><td>Inputs the reverse signal from CN1-8 input terminal.</td></tr> <tr><td style="text-align: center;">C</td><td>Inputs the reverse signal from CN1-9 input terminal.</td></tr> <tr><td style="text-align: center;">D</td><td>Inputs the reverse signal from CN1-10 input terminal.</td></tr> <tr><td style="text-align: center;">E</td><td>Inputs the reverse signal from CN1-11 input terminal.</td></tr> <tr><td style="text-align: center;">F</td><td>Inputs the reverse signal from CN1-12 input terminal.</td></tr> </tbody> </table>							Input Signal 3 Mapping for Command Option Module (/SI3)		0	Inputs the signal from CN1-13 input terminal.	1	Inputs the signal from CN1-7 input terminal.	2	Inputs the signal from CN1-8 input terminal.	3	Inputs the signal from CN1-9 input terminal.	4	Inputs the signal from CN1-10 input terminal.	5	Inputs the signal from CN1-11 input terminal.	6	Inputs the signal from CN1-12 input terminal.	7	Sets signal ON.	8	Sets signal OFF.	9	Inputs the reverse signal from CN1-13 input terminal.	A	Inputs the reverse signal from CN1-7 input terminal.	B	Inputs the reverse signal from CN1-8 input terminal.	C	Inputs the reverse signal from CN1-9 input terminal.	D	Inputs the reverse signal from CN1-10 input terminal.	E	Inputs the reverse signal from CN1-11 input terminal.	F	Inputs the reverse signal from CN1-12 input terminal.
	Input Signal 3 Mapping for Command Option Module (/SI3)																																								
	0	Inputs the signal from CN1-13 input terminal.																																							
	1	Inputs the signal from CN1-7 input terminal.																																							
	2	Inputs the signal from CN1-8 input terminal.																																							
	3	Inputs the signal from CN1-9 input terminal.																																							
	4	Inputs the signal from CN1-10 input terminal.																																							
	5	Inputs the signal from CN1-11 input terminal.																																							
6	Inputs the signal from CN1-12 input terminal.																																								
7	Sets signal ON.																																								
8	Sets signal OFF.																																								
9	Inputs the reverse signal from CN1-13 input terminal.																																								
A	Inputs the reverse signal from CN1-7 input terminal.																																								
B	Inputs the reverse signal from CN1-8 input terminal.																																								
C	Inputs the reverse signal from CN1-9 input terminal.																																								
D	Inputs the reverse signal from CN1-10 input terminal.																																								
E	Inputs the reverse signal from CN1-11 input terminal.																																								
F	Inputs the reverse signal from CN1-12 input terminal.																																								
<table border="1" style="width: 100%; border-collapse: collapse;"> <thead> <tr> <th colspan="2" style="background-color: #cccccc;">Input Signal 4 Mapping for Command Option Module (/SI4)</th> </tr> </thead> <tbody> <tr><td style="text-align: center;">4</td><td>Inputs the signal from CN1-10 input terminal.</td></tr> <tr><td style="text-align: center;">5</td><td>Inputs the signal from CN1-11 input terminal.</td></tr> <tr><td style="text-align: center;">6</td><td>Inputs the signal from CN1-12 input terminal.</td></tr> <tr><td style="text-align: center;">7</td><td>Sets signal ON.</td></tr> <tr><td style="text-align: center;">8</td><td>Sets signal OFF.</td></tr> <tr><td style="text-align: center;">D</td><td>Inputs the reverse signal from CN1-10 input terminal.</td></tr> <tr><td style="text-align: center;">E</td><td>Inputs the reverse signal from CN1-11 input terminal.</td></tr> <tr><td style="text-align: center;">F</td><td>Inputs the reverse signal from CN1-12 input terminal.</td></tr> <tr><td style="text-align: center;">0 to 3 9 to F</td><td>Sets signal OFF.</td></tr> </tbody> </table>							Input Signal 4 Mapping for Command Option Module (/SI4)		4	Inputs the signal from CN1-10 input terminal.	5	Inputs the signal from CN1-11 input terminal.	6	Inputs the signal from CN1-12 input terminal.	7	Sets signal ON.	8	Sets signal OFF.	D	Inputs the reverse signal from CN1-10 input terminal.	E	Inputs the reverse signal from CN1-11 input terminal.	F	Inputs the reverse signal from CN1-12 input terminal.	0 to 3 9 to F	Sets signal OFF.															
Input Signal 4 Mapping for Command Option Module (/SI4)																																									
4	Inputs the signal from CN1-10 input terminal.																																								
5	Inputs the signal from CN1-11 input terminal.																																								
6	Inputs the signal from CN1-12 input terminal.																																								
7	Sets signal ON.																																								
8	Sets signal OFF.																																								
D	Inputs the reverse signal from CN1-10 input terminal.																																								
E	Inputs the reverse signal from CN1-11 input terminal.																																								
F	Inputs the reverse signal from CN1-12 input terminal.																																								
0 to 3 9 to F	Sets signal OFF.																																								
<table border="1" style="width: 100%; border-collapse: collapse;"> <thead> <tr> <th colspan="2" style="background-color: #cccccc;">Input Signal 5 Mapping for Command Option Module (/SI5)</th> </tr> </thead> <tbody> <tr><td style="text-align: center;">0 to F</td><td>Same as /SI4 signal mapping.</td></tr> </tbody> </table>							Input Signal 5 Mapping for Command Option Module (/SI5)		0 to F	Same as /SI4 signal mapping.																															
Input Signal 5 Mapping for Command Option Module (/SI5)																																									
0 to F	Same as /SI4 signal mapping.																																								
<table border="1" style="width: 100%; border-collapse: collapse;"> <thead> <tr> <th colspan="2" style="background-color: #cccccc;">Input Signal 6 Mapping for Command Option Module (/SI6)</th> </tr> </thead> <tbody> <tr><td style="text-align: center;">0 to F</td><td>Same as /SI4 signal mapping.</td></tr> </tbody> </table>							Input Signal 6 Mapping for Command Option Module (/SI6)		0 to F	Same as /SI4 signal mapping.																															
Input Signal 6 Mapping for Command Option Module (/SI6)																																									
0 to F	Same as /SI4 signal mapping.																																								

(cont'd)

Parameter No.	Name	Setting Range	Units	Factory Setting	When Enabled	Classification	Reference Section																				
Pn512	Output Signal Inverse Setting	0000 to 0111	–	0000	After restart	Setup	3.3.2																				
	<p>n. <input type="checkbox"/> <input type="checkbox"/> <input type="checkbox"/> <input type="checkbox"/></p> <p>4th digit 3rd digit 2nd digit 1st digit</p> <table border="1"> <tr> <th colspan="2">Output Signal Inversion for CN1-1 or -2 Terminals</th> </tr> <tr> <td>0</td> <td>Does not invert outputs.</td> </tr> <tr> <td>1</td> <td>Inverts outputs.</td> </tr> <tr> <th colspan="2">Output Signal Inversion for CN1-23 or -24 Terminals</th> </tr> <tr> <td>0</td> <td>Does not invert outputs.</td> </tr> <tr> <td>1</td> <td>Inverts outputs.</td> </tr> <tr> <th colspan="2">Output Signal Inversion for CN1-25 or -26 Terminals</th> </tr> <tr> <td>0</td> <td>Does not invert outputs.</td> </tr> <tr> <td>1</td> <td>Inverts outputs.</td> </tr> <tr> <th colspan="2">Reserved (Do not change.)</th> </tr> </table>							Output Signal Inversion for CN1-1 or -2 Terminals		0	Does not invert outputs.	1	Inverts outputs.	Output Signal Inversion for CN1-23 or -24 Terminals		0	Does not invert outputs.	1	Inverts outputs.	Output Signal Inversion for CN1-25 or -26 Terminals		0	Does not invert outputs.	1	Inverts outputs.	Reserved (Do not change.)	
	Output Signal Inversion for CN1-1 or -2 Terminals																										
	0	Does not invert outputs.																									
	1	Inverts outputs.																									
	Output Signal Inversion for CN1-23 or -24 Terminals																										
	0	Does not invert outputs.																									
	1	Inverts outputs.																									
	Output Signal Inversion for CN1-25 or -26 Terminals																										
	0	Does not invert outputs.																									
1	Inverts outputs.																										
Reserved (Do not change.)																											
Pn513	Reserved Parameter (Do not change.)	–	–	0000	–	–	–																				
Pn517	Reserved Parameter (Do not change.)	–	–	0000	–	–	–																				
Pn51B	Excessive Error Level Between Servomotor and Load Positions	0 to 1073741824	1 reference unit	1000	Immediately	Setup	8.3.6																				
Pn51E	Excessive Position Error Warning Level	10 to 100	1%	100	Immediately	Setup	9.2.1																				
Pn520	Excessive Position Error Alarm Level	1 to 1073741823	1 reference unit	5242880	Immediately	Setup	5.1.4 9.1.1																				
Pn522	Positioning Completed Width	0 to 1073741824	1 reference unit	7	Immediately	Setup	–																				
Pn524	NEAR Signal Width	1 to 1073741824	1 reference unit	1073741824	Immediately	Setup	–																				
Pn526	Excessive Position Error Alarm Level at Servo ON	1 to 1073741823	1 reference unit	5242880	Immediately	Setup	9.1.1																				
Pn528	Excessive Position Error Warning Level at Servo ON	10 to 100	1%	100	Immediately	Setup	9.2.1																				
Pn529	Speed Limit Level at Servo ON	0 to 10000	1 min ⁻¹	10000	Immediately	Setup	9.1.1																				
Pn52A	Multiplier per One Fully-closed Rotation	0 to 100	1%	20	Immediately	Tuning	8.3.6																				
Pn52B	Overload Warning Level	1 to 100	1%	20	Immediately	Setup	4.2.11																				
Pn52C	Derating of Base Current at Detecting Overload of Motor	10 to 100	1%	100	After restart	Setup																					
Pn52F	Monitor Display at Power ON	0000 to 0FFF	–	0FFF	Immediately	Setup	–																				

(cont'd)

Parameter No.	Name	Setting Range	Units	Factory Setting	When Enabled	Classification	Reference Section																				
Pn530	Program JOG Operation Related Switch	0000 to 0005	–	0000	Immediately	Setup	6.5																				
	<div style="display: flex; align-items: center;"> <div style="margin-right: 10px;">n.</div> <div style="display: flex; gap: 5px;"> <div style="text-align: center;">4th digit <input type="checkbox"/></div> <div style="text-align: center;">3rd digit <input type="checkbox"/></div> <div style="text-align: center;">2nd digit <input type="checkbox"/></div> <div style="text-align: center;">1st digit <input type="checkbox"/></div> </div> </div> <table border="1" style="margin-left: 20px; border-collapse: collapse;"> <thead> <tr> <th colspan="2">Program JOG Operation Related Switch</th> </tr> </thead> <tbody> <tr> <td style="text-align: center;">0</td> <td>(Waiting time Pn535 → Forward movement Pn531) × Number of times of movement Pn536</td> </tr> <tr> <td style="text-align: center;">1</td> <td>(Waiting time Pn535 → Reverse movement Pn531) × Number of times of movements Pn536</td> </tr> <tr> <td style="text-align: center;">2</td> <td>(Waiting time Pn535 → Forward movement Pn531) × Number of times of movements Pn536 (Waiting time Pn535 → Reverse movement Pn531) × Number of times of movements Pn536</td> </tr> <tr> <td style="text-align: center;">3</td> <td>(Waiting time Pn535 → Reverse movement Pn531) × Number of times of movements Pn536 (Waiting time Pn535 → Forward movement Pn531) × Number of times of movements Pn536</td> </tr> <tr> <td style="text-align: center;">4</td> <td>(Waiting time Pn535 → Forward movement Pn531 → Waiting time Pn535 → Reverse movement Pn531) × Number of times of movement Pn536</td> </tr> <tr> <td style="text-align: center;">5</td> <td>(Waiting time Pn535 → Reverse movement Pn531 → Waiting time Pn535 → Forward movement Pn531) × Number of times of movement Pn536</td> </tr> <tr> <td colspan="2">Reserved (Do not change.)</td> </tr> <tr> <td colspan="2">Reserved (Do not change.)</td> </tr> <tr> <td colspan="2">Reserved (Do not change.)</td> </tr> </tbody> </table>							Program JOG Operation Related Switch		0	(Waiting time Pn535 → Forward movement Pn531) × Number of times of movement Pn536	1	(Waiting time Pn535 → Reverse movement Pn531) × Number of times of movements Pn536	2	(Waiting time Pn535 → Forward movement Pn531) × Number of times of movements Pn536 (Waiting time Pn535 → Reverse movement Pn531) × Number of times of movements Pn536	3	(Waiting time Pn535 → Reverse movement Pn531) × Number of times of movements Pn536 (Waiting time Pn535 → Forward movement Pn531) × Number of times of movements Pn536	4	(Waiting time Pn535 → Forward movement Pn531 → Waiting time Pn535 → Reverse movement Pn531) × Number of times of movement Pn536	5	(Waiting time Pn535 → Reverse movement Pn531 → Waiting time Pn535 → Forward movement Pn531) × Number of times of movement Pn536	Reserved (Do not change.)		Reserved (Do not change.)		Reserved (Do not change.)	
	Program JOG Operation Related Switch																										
	0	(Waiting time Pn535 → Forward movement Pn531) × Number of times of movement Pn536																									
	1	(Waiting time Pn535 → Reverse movement Pn531) × Number of times of movements Pn536																									
	2	(Waiting time Pn535 → Forward movement Pn531) × Number of times of movements Pn536 (Waiting time Pn535 → Reverse movement Pn531) × Number of times of movements Pn536																									
	3	(Waiting time Pn535 → Reverse movement Pn531) × Number of times of movements Pn536 (Waiting time Pn535 → Forward movement Pn531) × Number of times of movements Pn536																									
	4	(Waiting time Pn535 → Forward movement Pn531 → Waiting time Pn535 → Reverse movement Pn531) × Number of times of movement Pn536																									
	5	(Waiting time Pn535 → Reverse movement Pn531 → Waiting time Pn535 → Forward movement Pn531) × Number of times of movement Pn536																									
	Reserved (Do not change.)																										
Reserved (Do not change.)																											
Reserved (Do not change.)																											
Pn531	Program JOG Movement Distance	1 to 1073741824	1 reference unit	32768	Immediately	Setup	6.5																				
Pn533	Program JOG Movement Speed	1 to 10000	1 min ⁻¹	500	Immediately	Setup																					
Pn534	Program JOG Acceleration/Deceleration Time	2 to 10000	1 ms	100	Immediately	Setup																					
Pn535	Program JOG Waiting Time	0 to 10000	1 ms	100	Immediately	Setup																					
Pn536	Number of Times of Program JOG Movement	0 to 1000	1 time	1	Immediately	Setup																					
Pn550	Analog Monitor 1 Offset Voltage	-10000 to 10000	0.1 V	0.0	Immediately	Setup	5.1.3																				
Pn551	Analog Monitor 2 Offset Voltage	-10000 to 10000	0.1 V	0.0	Immediately	Setup																					
Pn552	Analog Monitor Magnification (×1)	-10000 to 10000	×0.01	100	Immediately	Setup																					
Pn553	Analog Monitor Magnification (×2)	-10000 to 10000	×0.01	100	Immediately	Setup																					
Pn560	Remained Vibration Detection Width	1 to 3000	0.1%	400	Immediately	Setup	5.7.1																				
Pn561	Overshoot Detection Level	0 to 100	1%	100	Immediately	Setup	5.3.1 5.4.1																				
Pn600	Regenerative Resistor Capacity *1	Depends on SERVOPACK Capacity *2	10 W	0	Immediately	Setup	3.7.2																				
Pn601	Reserved (Do not change.)	–	–	0	–	–	–																				
Pn800 to Pn95F *3	Reserved Parameter (Do not change.)	–	–	0	–	–	–																				

*1. Normally set to “0.” When using an external regenerative resistor, set the capacity (W) of the regenerative resistor.

*2. The upper limit is the maximum output capacity (W) of the SERVOPACK.

*3. For details on Pn800 to Pn95F, refer to the manual of the connected command option module.

10.2 Monitor Modes

The following list shows monitor modes available.

Un Number	Content of Display	Unit
Un000	Motor rotating speed	min ⁻¹
Un001	Speed reference (for speed control)	min ⁻¹
Un002	Internal torque reference (in percentage to the rated torque)	%
Un003	Electrical angle 1	pulse (encoder resolution)
Un004	Electrical angle 2	deg
Un005	Input signal monitor	–
Un006	Output signal monitor	–
Un007	Reference speed (for position control)	min ⁻¹
Un008	Position error amount (for position control)	reference unit
Un009	Accumulated load ratio (in percentage to the rated torque: effective torque in cycle of 10 seconds)	%
Un00A	Regenerative load ratio (in percentage to the processable regenerative power: regenerative power consumption in cycle of 10 seconds)	%
Un00B	Power consumed by DB resistance (in percentage to the processable power at DB activation: display in cycle of 10 seconds)	%
Un00C	Reference counter	reference unit
Un00D	Feedback pulse counter	pulse (encoder resolution)
Un00E	Fully-closed feedback pulse counter	pulse (encoder resolution)
Un012	Total operation time	100 ms
Un013	Feedback pulse counter	reference unit
Un014	Effective gain monitor (gain setting 1 = 1, gain setting 2 = 2)	–
Un015	Safety I/O signal monitor	–
Un020	Motor rated rotational speed	min ⁻¹
Un021	Motor maximum rotational speed	min ⁻¹

10.3 Parameter Recording Table

Use the following table for recording parameters.

Note: Pn10B, Pn170 and Pn408 have two kinds of digits: the digit which does not need the restart after changing the settings and the digit which needs the restart. The underlined digits of the factory setting in the following table show the digit which needs the restart.

Parameter	Factory Setting					Name	When Enabled
Pn000	0000					Basic Function Select Switch 0	After restart
Pn001	0000					Application Function Select Switch 1	After restart
Pn002	0000					Application Function Select Switch 2	After restart
Pn006	0002					Application Function Select Switch 6	Immediately
Pn007	0000					Application Function Select Switch 7	Immediately
Pn008	4000					Application Function Select Switch 8	After restart
Pn009	0010					Application Function Select Switch 9	After restart
Pn00B	0000					Application Function Select Switch B	After restart
Pn00C	0000					Application Function Select Switch C	After restart
Pn00D	0000					Application Function Select Switch D	After restart
Pn010	0001					Axis Address Selection (for UART/USB communications)	After restart
Pn081	0000					Application Function Select Switch 81	After restart
Pn100	40.0 Hz					Speed Loop Gain	Immediately
Pn101	20.00 ms					Speed Loop Integral Time Constant	Immediately
Pn102	40.0/s					Position Loop Gain	Immediately
Pn103	100%					Moment of Inertia Ratio	Immediately
Pn104	40.0 Hz					2nd Speed Loop Gain	Immediately
Pn105	20.00 ms					2nd Speed Loop Integral Time Constant	Immediately
Pn106	40.0/s					2nd Position Loop Gain	Immediately
Pn109	0%					Feedforward Gain	Immediately
Pn10A	0.00 ms					Feedforward Filter Time Constant	Immediately
Pn10B	<u>0000</u>					Application Function for Gain Select Switch	–
Pn10C	200%					Mode Switch (torque reference)	Immediately
Pn10D	0 min ⁻¹					Mode Switch (speed reference)	Immediately
Pn10E	0 min ⁻¹ /s					Mode Switch (acceleration)	Immediately
Pn10F	0 reference unit					Mode Switch (position error pulse)	Immediately
Pn11F	0.0 ms					Position Integral Time Constant	Immediately
Pn121	100%					Friction Compensation Gain	Immediately
Pn122	100%					2nd Gain for Friction Compensation	Immediately
Pn123	0%					Friction Compensation Coefficient	Immediately
Pn124	0.0 Hz					Friction Compensation Frequency Correction	Immediately
Pn125	100%					Friction Compensation Gain Correction	Immediately
Pn131	0 ms					Gain Switching Time 1	Immediately
Pn132	0 ms					Gain Switching Time 2	Immediately
Pn135	0 ms					Gain Switching Waiting Time 1	Immediately
Pn136	0 ms					Gain Switching Waiting Time 2	Immediately

(cont'd)

Parameter	Factory Setting					Name	When Enabled
Pn139	0000					Automatic Gain Changeover Related Switch 1	Immediately
Pn13D	2000%					Current Gain Level	Immediately
Pn140	0100					Model Following Control Related Switch	Immediately
Pn141	50.0/s					Model Following Control Gain	Immediately
Pn142	100%					Model Following Control Gain Compensation	Immediately
Pn143	100%					Model Following Control Bias (Forward Direction)	Immediately
Pn144	100%					Model Following Control Bias (Reverse Direction)	Immediately
Pn145	50.0 Hz					Vibration Suppression 1 Frequency A	Immediately
Pn146	70.0 Hz					Vibration Suppression 1 Frequency B	Immediately
Pn147	100.0%					Model Following Control Speed Feedforward Compensation	Immediately
Pn148	50.0/s					2nd Model Following Control Gain	Immediately
Pn149	100.0%					2nd Model Following Control Gain Compensation	Immediately
Pn14A	80.0 Hz					Vibration Suppression 2 Frequency	Immediately
Pn14B	100%					Vibration Suppression 2 Compensation	Immediately
Pn14F	0011					Reserved Parameter	–
Pn160	0010					Anti-Resonance Control Related Switch	After restart
Pn161	100.0 Hz					Anti-Resonance Frequency	Immediately
Pn162	100%					Anti-Resonance Gain Compensation	Immediately
Pn163	0%					Anti-Resonance Damping Gain	Immediately
Pn164	0.00 ms					Anti-Resonance Filter Time Constant 1 Compensation	Immediately
Pn165	0.00 ms					Anti-Resonance Filter Time Constant 2 Compensation	Immediately
Pn170	1401					Tuning-less Function Related Switch	–
Pn190	0010					Reserved Parameter	–
Pn200	0100					Reserved Parameter	–
Pn205	65535 Rev					Multiturn Limit	After restart
Pn207	0010					Position Control Function Switch	After restart
Pn20A	32768 Pitch/Rev					Number of External Scale Pitch	After restart
Pn20E	4					Electronic Gear Ratio (Numerator)	After restart
Pn210	1					Electronic Gear Ratio (Denominator)	After restart
Pn212	2048 P/Rev					Encoder Output Pulses	After restart
Pn216	0					Reserved Parameter	–
Pn217	0					Reserved Parameter	–
Pn22A	0000					Fully-closed Control Selection Switch	After restart
Pn281	20 P/Pitch					Encoder Output Resolution	After restart
Pn300	600					Reserved Parameter	–
Pn301	100					Reserved Parameter	–
Pn302	200					Reserved Parameter	–
Pn303	300					Reserved Parameter	–

(cont'd)

Parameter	Factory Setting					Name	When Enabled
Pn304	500 min ⁻¹					JOG Speed	Immediately
Pn305	0 ms					Soft Start Acceleration Time	Immediately
Pn306	0 ms					Soft Start Deceleration Time	Immediately
Pn307	40					Reserved Parameter	–
Pn310	0000					Vibration Detection Switch	Immediately
Pn311	100%					Vibration Detection Sensibility	Immediately
Pn312	50 min ⁻¹					Vibration Detection Level	Immediately
Pn324	300%					Moment of Inertia Calculating Start Level	Immediately
Pn400	30					Reserved Parameter	–
Pn401	1.00 ms					1st Step 1st Torque Reference Filter Time Constant	Immediately
Pn402	800%					Forward Torque Limit	Immediately
Pn403	800%					Reverse Torque Limit	Immediately
Pn404	100%					Forward External Torque Limit	Immediately
Pn405	100%					Reverse External Torque Limit	Immediately
Pn406	800%					Emergency Stop Torque	Immediately
Pn407	10000 min ⁻¹					Speed Limit during Torque Control	Immediately
Pn408	0000					Torque Related Function Switch	–
Pn409	5000 Hz					1st Notch Filter Frequency	Immediately
Pn40A	0.70					1st Notch Filter Q Value	Immediately
Pn40B	0.000					1st Notch Filter Depth	Immediately
Pn40C	5000 Hz					2nd Notch Filter Frequency	Immediately
Pn40D	0.70					2nd Notch Filter Q Value	Immediately
Pn40E	0.000					2nd Notch Filter Depth	Immediately
Pn40F	5000 Hz					2nd Step 2nd Torque Reference Filter Frequency	Immediately
Pn410	0.50					2nd Step 2nd Torque Reference Filter Q Value	Immediately
Pn412	1.00 ms					1st Step 2nd Torque Reference Filter Time Constant	Immediately
Pn423	0000					Reserved Parameter	–
Pn424	50%					Torque Limit at Main Circuit Voltage Drop	Immediately
Pn425	100 ms					Release Time for Torque Limit at Main Circuit Voltage Drop	Immediately
Pn456	15%					Sweep Torque Reference Amplitude	Immediately
Pn460	0101					Notch Filter Adjustment Switch	Immediately
Pn501	10					Reserved Parameter	–
Pn502	20 min ⁻¹					Rotation Detection Level	Immediately
Pn503	10 min ⁻¹					Speed Coincidence Signal Output Width	Immediately
Pn506	0 ms					Brake Reference - Servo OFF Delay Time	Immediately
Pn507	100 min ⁻¹					Brake Reference Output Speed Level	Immediately
Pn508	50 ms					Waiting Time for Brake Signal When Motor Running	Immediately
Pn509	20 ms					Instantaneous Power Cut Hold time	Immediately

(cont'd)

Parameter	Factory Setting					Name	When Enabled
Pn50A	1881					Input Signal Selection 1	After restart
Pn50B	8822					Input Signal Selection 2	After restart
Pn50E	0000					Output Signal Selection 1	After restart
Pn50F	0100					Output Signal Selection 2	After restart
Pn510	0000					Output Signal Selection 3	After restart
Pn511	6543					Input Signal Selection 5	After restart
Pn512	0000					Output Signal Inverse Setting	After restart
Pn513	0000					Reserved Parameter	–
Pn517	0000					Reserved Parameter	–
Pn51B	1000 reference unit					Excessive Error Level Between Servomotor and Load Positions	Immediately
Pn51E	100%					Excessive Position Error Warning Level	Immediately
Pn520	5242880 reference unit					Excessive Position Error Alarm Level	Immediately
Pn522	7 reference unit					Positioning Completed Width	Immediately
Pn524	1073741824 reference unit					NEAR Signal Width	Immediately
Pn526	5242880 reference unit					Excessive Position Error Alarm Level at Servo ON	Immediately
Pn528	100%					Excessive Position Error Warning Level at Servo ON	Immediately
Pn529	10000 min ⁻¹					Speed Limit Level at Servo ON	Immediately
Pn52A	20%					Multiplier per One Fully-closed Rotation	Immediately
Pn52B	20%					Overload Warning Level	Immediately
Pn52C	100%					Derating of Base Current at Detecting Overload of Motor	After restart
Pn52F	0FFF					Monitor Display at Power ON	Immediately
Pn530	0000					Program JOG Operation Related Switch	Immediately
Pn531	32768 reference unit					Program JOG Movement Distance	Immediately
Pn533	500 min ⁻¹					Program JOG Movement Speed	Immediately
Pn534	100 ms					Program JOG Acceleration/Deceleration Time	Immediately
Pn535	100 ms					Program JOG Waiting Time	Immediately
Pn536	1 time					Number of Times of Program JOG Movement	Immediately
Pn550	0.0 V					Analog Monitor 1 Offset Voltage	Immediately
Pn551	0.0 V					Analog Monitor 2 Offset Voltage	Immediately
Pn552	×1					Analog Monitor Magnification (×1)	Immediately
Pn553	×1					Analog Monitor Magnification (×2)	Immediately
Pn560	40.0%					Remained Vibration Detection Width	Immediately
Pn561	100%					Overshoot Detection Level	Immediately
Pn600	0 W					Regenerative Resistor Capacity	Immediately
Pn601	0					Reserved Parameter	–
Pn 800 to Pn95F	0					Reserved Parameter	–

Index

Symbols

*BB	4-28
*HBB	4-28
*N-OT	4-28
*P-OT	4-28
*PT NT	4-28
*RUN	4-28
/BK	3-24, 4-15
/BK-	3-20
/CLT	3-24, 4-31
/COIN	3-24
/HWBB1	3-20
/HWBB2	3-20
/N-CL	4-30
/NEAR	3-24
/P-CL	4-30
/SI0	3-19
/SI3	3-19
/SI4	3-19
/SI5	3-19
/SI6	3-19
/SO1-	3-20
/SO1+	3-20
/S-RDY	3-24
/TGON	3-24
/V-CMP	3-24
/VLT	3-24
/WARN	3-24

Numerics

600 V grade heat-resistant polyvinyl chloride insulated wire	3-3
--	-----

A

absolute data reception sequence	4-39
absolute data request (Sensor_ON)	4-35
absolute encoder	
reception sequence	4-39
setup initialization	4-38
absolute encoders	4-32
connection	4-33
initial incremental pulses	4-40
rotational serial data	4-40
AC reactor	3-39
AC/DC reactor for harmonic suppression	3-39
advanced autotuning (Fn201)	5-15
anti-resonance control adjustment function	5-21
calculating moment of inertia	5-18
feedforward	5-22
friction compensation	5-22
mode selection	5-18
notch filter	5-21
STROKE (travel distance) setting	5-18
type selection	5-18
vibration suppression	5-21
advanced autotuning by reference (Fn202)	5-24
anti-resonance control adjustment	5-28
feedforward	5-29
friction compensation	5-29
mode selection	5-26
notch filter	5-28

type selection	5-26
vibration suppression	5-28
alarm	
alarm history display (Fn000)	6-3
clearing alarm history (Fn006)	6-14
list of alarms	9-2
stopping method for servomotor when an alarm occurs	4-19
troubleshooting of alarms	9-6
alarm reset capability	9-2
alarm stopping method	9-2
ALM-	3-20
ALM+	3-20
analog monitor	
connector CN5 for analog monitor	5-7
gain adjustment of analog monitor output (Fn00D)	6-17
monitoring analog signals	5-5
offset adjustment of analog monitor output (Fn00C)	6-15
setting monitor factor	5-6
anti-resonance control adjustment function (Fn204)	5-40
applicable standards	1-4
automatic gain switching	5-52
automatic offset-signal adjustment of the motor current	
detection (Fn00E)	6-19
automatically setting the notch filter	5-11

B

BAT(-)	3-19
BAT(+)	3-19
battery	
battery case	4-32
installing the battery in the host controller	4-34
using an encoder cable with a battery case	4-33
brake operation delay time	4-14
brake signals	4-15

C

CCW	8-15
CE	xiii
changing detection timing of overload alarm (A.720)	4-25
changing detection timing of overload warning (A.910)	4-24
CN1	3-19
CN2	3-30
CN3	1-2
CN7	1-2
CN8	3-20
coast to a stop	4-6
COM LED	1-2
connecting a safety device	4-53
connecting regenerative resistors	3-32
connection example and specifications of EDM1 output signal	4-50
connection example for input signals (HWBB signals)	4-47
correct grounding	3-36
current control mode selection	5-58
current gain level setting	5-58
CW	8-15

D

damping gain	5-40
DC power input	
parameter settings	3-15
DC power supply input	
wiring example	3-16
DC reactor	3-39
DC reactor connection terminal for power supply	
harmonic suppression	3-2
decelerate to stop	4-6

digital operator display during testing without motor ----- 4-28
 DIP switch (S2) ----- 1-2
 display of servomotor ID in feedback option module (Fn01F) -- 6-29
 dynamic brake ----- 4-6

E

EasyFFT (Fn206) ----- 6-32
 EDM1 ----- 3-28, 4-49
 EDM1 output signal specifications ----- 4-50
 EDM1 signal output connection example ----- 4-50
 electric gear ratio ----- 4-8
 electronic gear ----- 4-8
 electronic gear ratio setting examples ----- 4-10
 encoder
 encoder output pulse setting ----- 4-12
 encoder output pulses ----- 4-11
 encoder resolution ----- 4-9, 4-12
 encoder signal (CN2) names and functions ----- 3-30
 example of connecting an encoder (absolute encoder) ----- 3-31
 example of connecting an encoder (incremental encoder) -- 3-30
 error detection in HWBB signal ----- 4-46
 examples of connection to the host controller
 sequence input circuits ----- 3-25
 sequence output circuits ----- 3-27
 external device monitor ----- 4-49
 external regenerative resistor terminals ----- 3-2
 external torque limit ----- 4-30

F

feedback of position ----- 4-11
 feedforward control compensation ----- 5-59
 feedforward reference ----- 5-59
 FG ----- 3-20, 3-21
 forward external torque limit ----- 4-30
 friction compensation ----- 5-56
 fully-closed loop control
 alarm detection ----- 8-22
 analog monitor signal ----- 8-23
 analog signal input timing ----- 8-5
 connection example of external encoder by Heidenhain ----- 8-6
 connection example of external encoder
 by Magnescale Co., Ltd. ----- 8-6
 connection example of external encoder
 by Mitutoyo Corporation ----- 8-6
 connection example of external encoder
 by Renishaw plc ----- 8-6
 electronic gear ----- 8-21
 external absolute encoder data reception sequence ----- 8-18
 internal block diagram ----- 8-3
 motor rotation direction ----- 8-15
 serial converter unit ----- 8-4
 setting encoder output pulses ----- 8-17
 sine wave pitch (frequency) for an external encoder ----- 8-17
 speed feedback method ----- 8-23
 system configuration ----- 8-2

G

gear ratio ----- 4-8
 Gr.1 ----- 9-2
 Gr.1 alarm ----- 4-19
 Gr.2 ----- 9-2
 Gr.2 alarm ----- 4-19
 ground fault detector ----- 3-18

H

hard wire base block (HWBB) function ----- 4-44
 hard wire base block (HWBB) state ----- 4-45
 holding brakes ----- 4-13
 HWBB state ----- 4-45

I

I/O signal
 output signal allocation ----- 3-24
 I/O signal (CN1)
 input signal allocations ----- 3-22
 names and functions ----- 3-19
 infinite time operation ----- 6-9
 input reference pulse ----- 4-8
 inrush current limit circuit ----- 3-15
 instantaneous power interruption settings ----- 4-20
 interpreting the input signal allocation tables ----- 3-22
 interpreting the output signal allocation tables ----- 3-24

J

JOG operation (Fn002) ----- 6-4

L

limit switches ----- 4-5
 line driver output circuit ----- 3-27

M

machine vibration ----- 6-36
 main circuit
 names and specifications ----- 3-2
 wires ----- 3-3
 wiring examples ----- 3-5
 main circuit minus terminal ----- 3-3
 main circuit plus terminal ----- 3-3
 manual gain switching ----- 5-51
 manual offset-signal adjustment of the motor current
 detection (Fn00F) ----- 6-20
 molded-case circuit breaker ----- 3-18
 monitor display
 example of monitor displays ----- 7-3
 list of monitor modes ----- 7-2
 monitor mode (Un□□□) ----- 2-7
 monitor modes ----- 10-22
 motor overload detection level ----- 4-24
 multiturn limit disagreement alarm (A.CC0) ----- 4-43
 multiturn limit setting ----- 4-42

N

North American safety standards (UL/CSA) ----- xiii
 N-OT ----- 3-19, 4-5
 notch filters ----- 5-64

O

one-parameter tuning (Fn203) ----- 5-31
 anti-resonance control adjustment ----- 5-36
 example ----- 5-38
 feedforward ----- 5-37
 friction compensation ----- 5-36
 notch filter ----- 5-36
 tuning mode ----- 5-34
 type selection ----- 5-34
 online vibration monitor (Fn207) ----- 6-36
 operation
 inspection and checking before operation ----- 4-3
 operating the servomotor alone ----- 4-3
 origin search (Fn003) ----- 6-6

origin setting (Fn020)	6-30
outline of absolute signals	4-39
output phase	4-11
output signal(CN1)	3-20
overtravel (OT)	4-5
overtravel warning function	4-7

P

P control	5-59
panel display	2-2
PAO	4-11
parameters	
classifications	2-4
initializing parameter settings (Fn005)	6-13
list of parameters	10-2
notation (numeric parameters)	2-4
notation (selection parameters)	2-4
parameter recording table	10-23
setting method (numeric parameters)	2-5
setting method (selection parameters)	2-6
setting methods (Pn□□□)	2-5
tuning parameters	2-4
write prohibited setting (Fn010)	6-21
PBO	4-11
PCO	4-11
photocoupler output circuit	3-27
PI control	5-59
P-OT	3-19, 4-5
POWER LED	1-2
power ON sequence	3-5
precautions for wiring	3-18
program JOG operation (Fn004)	6-8
program JOG operation patterns	6-9
protection class/pollution degree	1-4

R

regenerative resistor unit	3-33
resetting configuration error of option module (Fn014)	6-25
resetting the HWBB state	4-46
resonance frequency	6-32
reverse external torque limit	4-30
risk assessment	4-44
rotary switch (S1)	1-2
Rotational Serial Data Specifications	4-41
Rotational Serial Data Specifications and Initial Incremental Pulses	4-41

S

safety function	4-44
example of I/O signal connections	3-21
safety function signal (CN8) names and functions	3-20
safety functions	
application example	4-51
confirmation	4-52
precautions for safety functions	4-54
safety output circuit	3-28
SEMI-F47 function	4-21
servo gain	5-3
servomotor model display (Fn011)	6-23
servomotor rotation direction	4-4
SERVOPACKs	
ambient/storage humidity	1-4
basic specifications	1-4
display of SERVOPACK and servomotor ID (Fn01E)	6-28
example of servo system configurations (SGDV-□□□FE1A)	1-14

examples of servo system configurations (SGDV-□□□AE1A)	1-15
examples of servo system configurations (SGDV-□□□DE1A)	1-17
inspection and maintenance	1-19
model designation	1-18
part names	1-2
precautions when using more than one SERVOPACK	3-17
ratings	1-3
software version display (Fn012)	6-24
surrounding air/storage temperature	1-4
setting regenerative resistor capacity	3-34
single-phase 200 V power input	
parameter setting	3-12
single-phase 200 V power supply input	
molded-case circuit breaker	3-14
power supply capacities and power losses	3-14
SERVOPACK main circuit wire	3-13
wire types	3-3
wiring example	3-13
single-phase power input	3-12
SO2-	3-20
SO2+	3-20
SO3-	3-20
SO3+	3-20
software reset (Fn030)	6-31
specifications of input signals (HWBB signals)	4-47
speed control range	1-4
speed detection method selection	5-58
speed regulation	1-4
standard power supply input	
circuit breaker	3-10
parameter settings	3-15
power supply capacity and power loss	3-9
SERVOPACK main circuit wire	3-4
wire types	3-3
wiring examples	3-5
status display	2-2
stopping method for servomotor after receiving Servo OFF command	4-18
stopping method for servomotor for Gr.1 alarms	4-19
stopping method for servomotor for Gr.2 alarms	4-19
SW1	1-2
SW2	1-2
switching condition A	5-52
switching gain settings	5-51

T

terminator	3-29
test without motor function	4-26
time stamps	6-3
torque control tolerance	1-4
torque limit	
internal torque limit	4-29
output signals	4-31
torque reference filter	5-64
guide	5-64
troubleshooting malfunction based on operation and conditions of the servomotor	9-28
tuning	
additional adjustment function	5-51
compatible adjustment function	5-59
safety precautions on adjustment of servo gains	5-8
tuning-less function	5-10
tuning-less level settings	5-11
tuning parameters	2-4

tuning-less adjustment level	5-11
tuning-less load level	5-12

U

UL	xiii
using the mode switch (P/PI switching)	5-59
utility functions	10-2
utility functions that can be write-protected	6-21

V

vibration detection level initialization (Fn01B)	6-26
vibration suppression function (Fn205)	5-46
feedforward	5-49
vibration/shock resistance	1-4

W

warning	
troubleshooting of warnings	9-24
warning displays	9-22
wiring for noise control	3-35
noise filter	3-36
precautions on connecting noise filter	3-37

Z

zero clamp mode	4-6
-----------------------	-----

Revision History

The revision dates and numbers of the revised manuals are given on the bottom of the back cover.

MANUAL NO. SIEP S800000 60A

Published in Japan April 2010 09-6 \diamond - 1

└─ WEB revision number
└─ Revision number
└─ Date of original publication
└─ Date of publication

Date of Publication	Rev. No.	WEB Rev. No.	Section	Revised Content
August 2013	\diamond 3	0	Preface, 1.4.2	Revision: Description of Applicable Standards EN55011/A2 changed to EN55011
			Back cover	Revision: Address
May 2012	\diamond 2	0	Back cover	Revision: Address
November 2011	\diamond 1	0	Front cover	Revision: Description of technical terms, Manuals related to the Σ -V series, Safety precautions
			1.2	Addition: SERVOPACKs
			Chapter 3, 4, 8	Slightly revised
			5.1.4 (3), 5.1.4 (5), 6.5 (2), 10.1.2	Revision: Description of related parameters
			10.1.2, 10.3	Addition: Pn081
November 2010	\diamond 0	2	Front cover	Revision: Format
			3.4.1 (1), 3.4.2 (3), 4.6.1, 4.6.1 (5), 4.6.2 (1), 4.6.3 (1)	Revision: Connection example
			5.3.1(1), 5.4.1(1)	Revision: Description of things to do before advanced autotuning and advanced autotuning by reference
			5.8.4	Revision: Description of current gain level setting
			8.3.4(2), 10.1.2	Revision: Setting units of Pn281
			Back cover	Revision: Address, format
			April 2010	\diamond 0
5.8.1 (4), (5)	Revision: Applicable control method			
8.3.1	Addition: Description of Note			
10.1.2, 10.3	Addition: Pn517 (Reserved Parameter)			
Back cover	Revision: Address			
June 2009	–	–	–	First edition

AC Servo Drives

Σ -V Series

USER'S MANUAL

Design and Maintenance

Rotational Motor

Command Option Attachable Type

IRUMA BUSINESS CENTER (SOLUTION CENTER)

480, Kamifujisawa, Iruma, Saitama 358-8555, Japan
Phone 81-4-2962-5151 Fax 81-4-2962-6138
<http://www.yaskawa.co.jp>

YASKAWA AMERICA, INC.

2121 Norman Drive South, Waukegan, IL 60085, U.S.A.
Phone 1-800-YASKAWA (927-5292) or 1-847-887-7000 Fax 1-847-887-7310
<http://www.yaskawa.com>

YASKAWA ELÉTRICO DO BRASIL LTDA.

Avenida Piraporinha 777, Diadema, São Paulo, 09950-000, Brasil
Phone 55-11-3585-1100 Fax 55-11-3585-1187
<http://www.yaskawa.com.br>

YASKAWA EUROPE GmbH

Hauptstraße 185, Eschborn 65760, Germany
Phone 49-6196-569-300 Fax 49-6196-569-398
<http://www.yaskawa.eu.com>

YASKAWA ELECTRIC KOREA CORPORATION

9F, Kyobo Securities Bldg, 26-4, Yeouido-dong, Yeongdeungpo-gu, Seoul, 150-737, Korea
Phone 82-2-784-7844 Fax 82-2-784-8495
<http://www.yaskawa.co.kr>

YASKAWA ELECTRIC (SINGAPORE) PTE. LTD.

151 Lorong Chuan, #04-02A, New Tech Park 556741, Singapore
Phone 65-6282-3003 Fax 65-6289-3003
<http://www.yaskawa.com.sg>

YASKAWA ELECTRIC (CHINA) CO., LTD.

12F, Carlton Bld., No.21 HuangHe Road, HuangPu District, Shanghai 200003, China
Phone 86-21-5385-2200 Fax 86-21-5385-3299
<http://www.yaskawa.com.cn>

YASKAWA ELECTRIC (CHINA) CO., LTD. BEIJING OFFICE

Room 1011, Tower W3 Oriental Plaza, No.1 East Chang An Ave.,
Dong Cheng District, Beijing 100738, China
Phone 86-10-8518-4086 Fax 86-10-8518-4082

YASKAWA ELECTRIC TAIWAN CORPORATION

9F, 16, Nanking E. Rd., Sec. 3, Taipei 104, Taiwan
Phone 886-2-2502-5003 Fax 886-2-2505-1280



YASKAWA ELECTRIC CORPORATION

In the event that the end user of this product is to be the military and said product is to be employed in any weapons systems or the manufacture thereof, the export will fall under the relevant regulations as stipulated in the Foreign Exchange and Foreign Trade Regulations. Therefore, be sure to follow all procedures and submit all relevant documentation according to any and all rules, regulations and laws that may apply.

Specifications are subject to change without notice for ongoing product modifications and improvements.

© 2009-2013 YASKAWA ELECTRIC CORPORATION. All rights reserved.

MANUAL NO. SIEP S800000 60C

Published in Japan August 2013 09-6 -0

13-6-9

Original instructions